

Spezifikation für Freigabe / specification for release

Kunde / customer :

Artikelnummer / part number : **744272222**



Bezeichnung : **STROMKOMP. SMD LINE FILTER WE-SL5**
 description : **COMMON MODE SMD LINE FILTER WE-SL5**

DATUM/DATE: 2008-01-14

A Mechanische Abmessungen / dimensions:

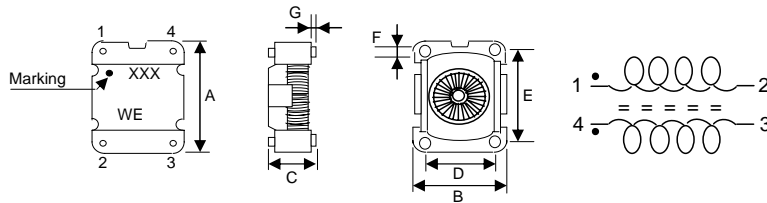

| | | |
|---|-------------------|----|
| A | 10,0 ± 0,3 | mm |
| B | 8,70 ± 0,3 | mm |
| C | 6,50 max. | mm |
| D | 6,22 ± 0,1 | mm |
| E | 7,62 ± 0,1 | mm |
| F | 1,25 ± 0,1 | mm |
| G | 0,30 min. | mm |

B Elektrische Eigenschaften / electrical properties:

| Eigenschaften / properties | Testbedingungen / test conditions | | Wert / value | Einheit / unit | tol. |
|-------------------------------|---|---------------|--------------|----------------|-------------|
| Induktivität / inductance | 0,1V / 100KHz | $L_{1-2,4-3}$ | 2200 | μH | ±40% |
| DC-Widerstand / DC-resistance | | R_{DC} | 0,300 | Ω | max. |
| Nennstrom / rated current | $\Delta T = 40\text{K}$ | I_{DC} | 750 | mA | max. |
| Impedanz / impedance | | Z_{com} | 7500 | Ω | max. |
| Nennspannung / rated voltage | | U_{DC} | 80 | V | max. |

C Lötpad / soldering spec.:

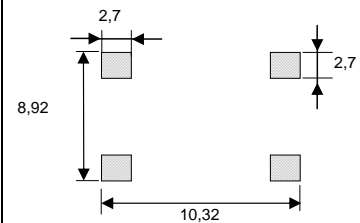

D Prüfgeräte / test equipment:

HP 4191 B für/for Z und/and material
HP 34401 A für/for R_{DC} und/and IDC

E Testbedingungen / test conditions:

Luftfeuchtigkeit / humidity: 33%
 Umgebungstemperatur / temperature: +20°C
 Spannungsfestigkeit / High-Pot Test (60Hz;1mA;1min.) 300VAC

F Werkstoffe & Zulassungen / material & approvals:

Basismaterial / base material: Ferrit/ ferrite
 Draht / wire: 2-SFBW / 155°C
 Gehäuse / Housing: UL94-V0

G Eigenschaften / general specifications:

Betriebstemp. / operating temperature: -40°C - +125°C
 Umgebungstemp. / ambient temperature: -40°C - +85°C
 It is recommended that the temperature of the part does not exceed 125°C under worst case operating conditions.

| | | | |
|-------------------------------------|--------------------------|-------------------------|--------------|
| Freigabe erteilt / general release: | Kunde / customer | | |
| | | | |
| Datum / date | Unterschrift / signature | | |
| Geprüft / checked | Würth Elektronik | | |
| | SSt | Version 4 | 08-01-14 |
| | MST | Version 3 | 06-05-09 |
| | MST | Version 2 | 04-10-11 |
| Kontrolliert / approved | ME | Version 1 | 04-04-26 |
| | Name | Änderung / modification | Datum / date |

Würth Elektronik eiSos GmbH & Co. KG

D-74638 Waldenburg · Max-Eyth-Strasse 1 - 3 · Germany · Telefon (+49) (0) 7942 - 945 - 0 · Telefax (+49) (0) 7942 - 945 - 400
<http://www.we-online.com>

Spezifikation für Freigabe / specification for release

Kunde / customer : _____
 Artikelnummer / part number : **744272222**
 Bezeichnung : **STROMKOMP. SMD LINE FILTER WE-SL5**
 description : **COMMON MODE SMD LINE FILTER WE-SL5**



DATUM/DATE: 2008-01-14

H Impedanzverlauf / impedance curve:

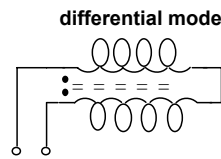
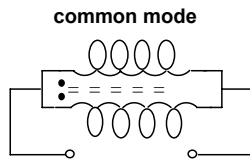
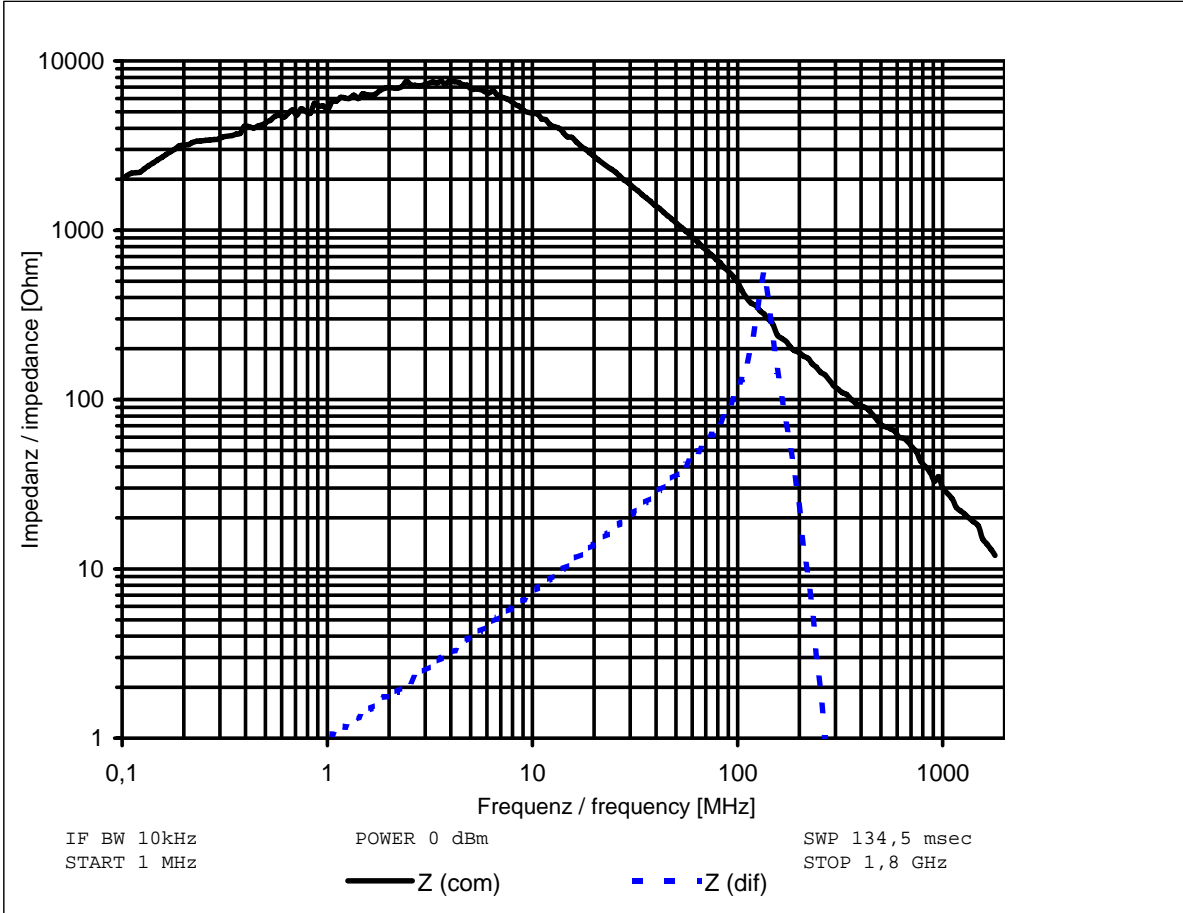

| | | | | |
|-------------------------------------|--------------------------|------|--------------------------------|--------------|
| Freigabe erteilt / general release: | Kunde / customer | | | |
| | | | | |
| Datum / date | Unterschrift / signature | SSt | Version 4 | 08-01-14 |
| | Würth Elektronik | MST | Version 3 | 06-05-09 |
| | | MST | Version 2 | 04-10-11 |
| | | ME | Version 1 | 04-04-26 |
| Geprüft / checked | Kontrolliert / approved | Name | Änderung / modification | Datum / date |

Würth Elektronik eiSos GmbH & Co. KG

D-74638 Waldenburg · Max-Eyth-Strasse 1 - 3 · Germany · Telefon (+49) (0) 7942 - 945 - 0 · Telefax (+49) (0) 7942 - 945 - 400
<http://www.we-online.com>

Spezifikation für Freigabe / specification for release

Kunde / customer : _____
 Artikelnummer / part number : **744272222**
 Bezeichnung : **STROMKOMP. SMD LINE FILTER WE-SL5**
 description : **COMMON MODE SMD LINE FILTER WE-SL5**



DATUM/DATE: 2008-01-14

I Rollenspezifikation / tape and reel specification:

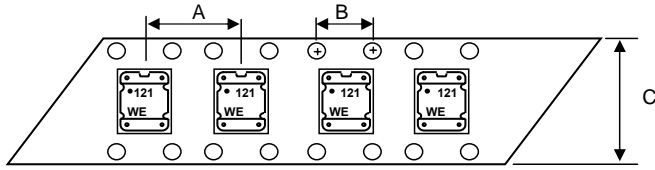

Gurtspezifikation / Tape specification:

| | | |
|---|-----------|----|
| A | 12 | mm |
| B | 4 | mm |
| C | 24 | mm |
| D | | mm |
| E | | mm |
| F | | mm |
| G | | mm |
| H | | mm |
| I | | mm |
| J | | mm |
| T | | mm |

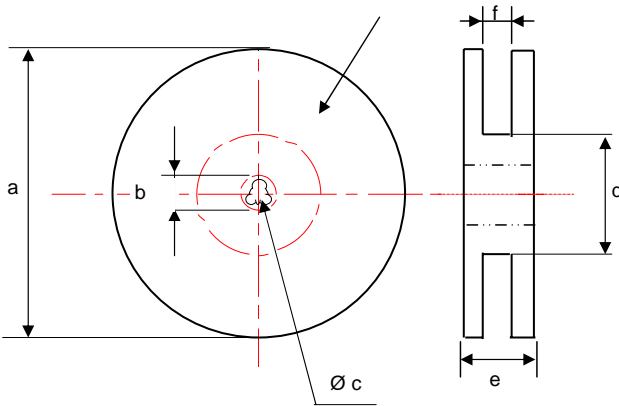

Rollenspezifikation / Reel specification:

| | | |
|---|------------------|----|
| a | 330 ± 2,0 | mm |
| b | 21 ± 0,8 | mm |
| c | 13 ± 0,5 | mm |
| d | 50 ± 1,0 | mm |
| e | 30,4 | mm |
| f | 26 | mm |

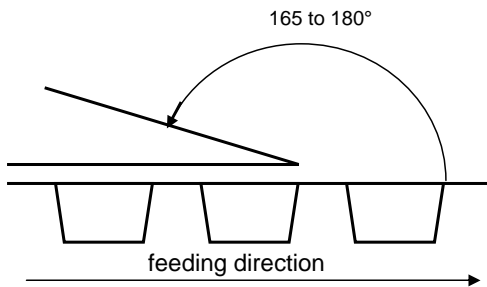

The force for tearing off cover tape is 10 to 130 grams in arrow direction

| | | | | | | |
|-------------------------------------|--------------------------|--|--|------|-------------------------|--------------|
| Freigabe erteilt / general release: | Kunde / customer | | | | | |
| | | | | | | |
| Datum / date | Unterschrift / signature | | | SSt | Version 4 | 08-01-14 |
| | Würth Elektronik | | | MST | Version 3 | 06-05-09 |
| | | | | MST | Version 2 | 04-10-11 |
| | | | | ME | Version 1 | 04-04-26 |
| Geprüft / checked | Kontrolliert / approved | | | Name | Änderung / modification | Datum / date |

This electronic component has been designed and developed for usage in general electronic equipment. Before incorporating this component into any equipment where higher safety and reliability is especially required or if there is the possibility of direct damage or injury to human body, for example in the range of aerospace, aviation, nuclear control, submarine, transportation, (automotive control, train control, ship control), transportation signal, disaster prevention, medical, public information network etc, Würth Elektronik eiSos GmbH must be informed before the design-in stage. In addition, sufficient reliability evaluation checks for safety must be performed on every electronic component which is used in electrical circuits that require high safety and reliability functions or performance.

Würth Elektronik eiSos GmbH & Co. KG

D-74638 Waldenburg · Max-Eyth-Strasse 1 - 3 · Germany · Telefon (+49) (0) 7942 - 945 - 0 · Telefax (+49) (0) 7942 - 945 - 400
<http://www.we-online.com>