

# Spezifikation für Freigabe / specification for release

Kunde / customer :

Artikelnummer / part number :

**744232261**

LF



Bezeichnung : **SMD Stromkomp. Datenleitungsfilter WE-CNSW**

description : **SMD common mode noise suppressor WE-CNSW**

DATUM / DATE : 2004-10-11

## A Mechanische Abmessungen / dimensions:

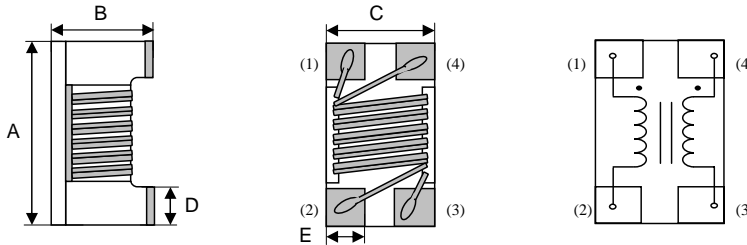

	1206	
A	<b>3,2 ± 0,2</b>	mm
B	<b>1,9 ± 0,2</b>	mm
C	<b>1,6 ± 0,2</b>	mm
D	<b>0,6 ref.</b>	mm
E	<b>0,6 ref.</b>	mm

## B Elektrische Eigenschaften / electrical properties:

Eigenschaften / properties	Testbedingungen / test conditions		Wert / value	Einheit / unit	tol.
Impedanz / impedance	<b>100 MHz</b>	Z	<b>260</b>	Ω	<b>± 25 %</b>
Nennspannung / rated voltage		U	<b>50</b>	V	<b>max.</b>
DC-Widerstand / DC-resistance	<b>@ 20°C</b>	R <sub>DC</sub>	<b>0,50</b>	Ω	<b>max.</b>
Nennstrom / rated current	<b>ΔT= 15 K</b>	I <sub>DC</sub>	<b>310</b>	mA	<b>max.</b>

## C Lötpad / soldering spec.:

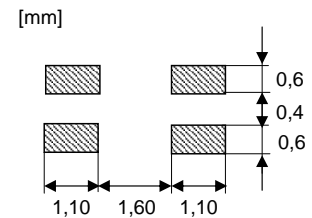

## D Prüfgeräte / test equipment:

**HP 4191 B** für/for Z und/and L

**HP 34401 A** für/for R<sub>DC</sub> und/and I<sub>DC</sub>

## E Testbedingungen / test conditions:

Luftfeuchtigkeit / humidity: 33%

Umgebungstemperatur / temperature: +20°C

## F Werkstoffe & Zulassungen / material & approvals:

Basismaterial / base material:

Ferrit

## G Eigenschaften / general specifications:

Lagertemperatur / storage temperature: -40°C - + 125°C

Betriebstemp. / operating temperature: -40°C - + 125°C

Freigabe erteilt / general release:	Kunde / customer		
Datum / date	Unterschrift / signature		
	Würth Elektronik		
Geprüft / checked	MST	Version 3	04-10-11
	SST	Version 2	04-02-17
	MST	Version 1	03-11-25
	Name	<b>Änderung / modification</b>	Datum / date

**Würth Elektronik eiSos GmbH & Co. KG**

D-74638 Waldenburg · Max-Eyth-Strasse 1 -3 · Germany · Telefon (+49) (0) 7942 - 945 - 0 · Telefax (+49) (0) 7942 - 945 - 400  
http://www.we-online.com

# Spezifikation für Freigabe / specification for release

Kunde / customer : \_\_\_\_\_  
 Artikelnummer / part number : **744232261** LF  
 Bezeichnung : **SMD Stromkomp. Datenleitungsfilter WE-CNSW**  
 description : **SMD common mode noise suppressor WE-CNSW**



## H Impedanzverlauf / impedance curve:

DATUM / DATE : 2004-10-11

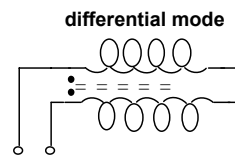
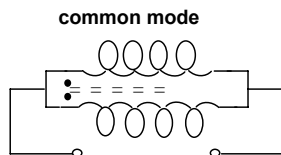
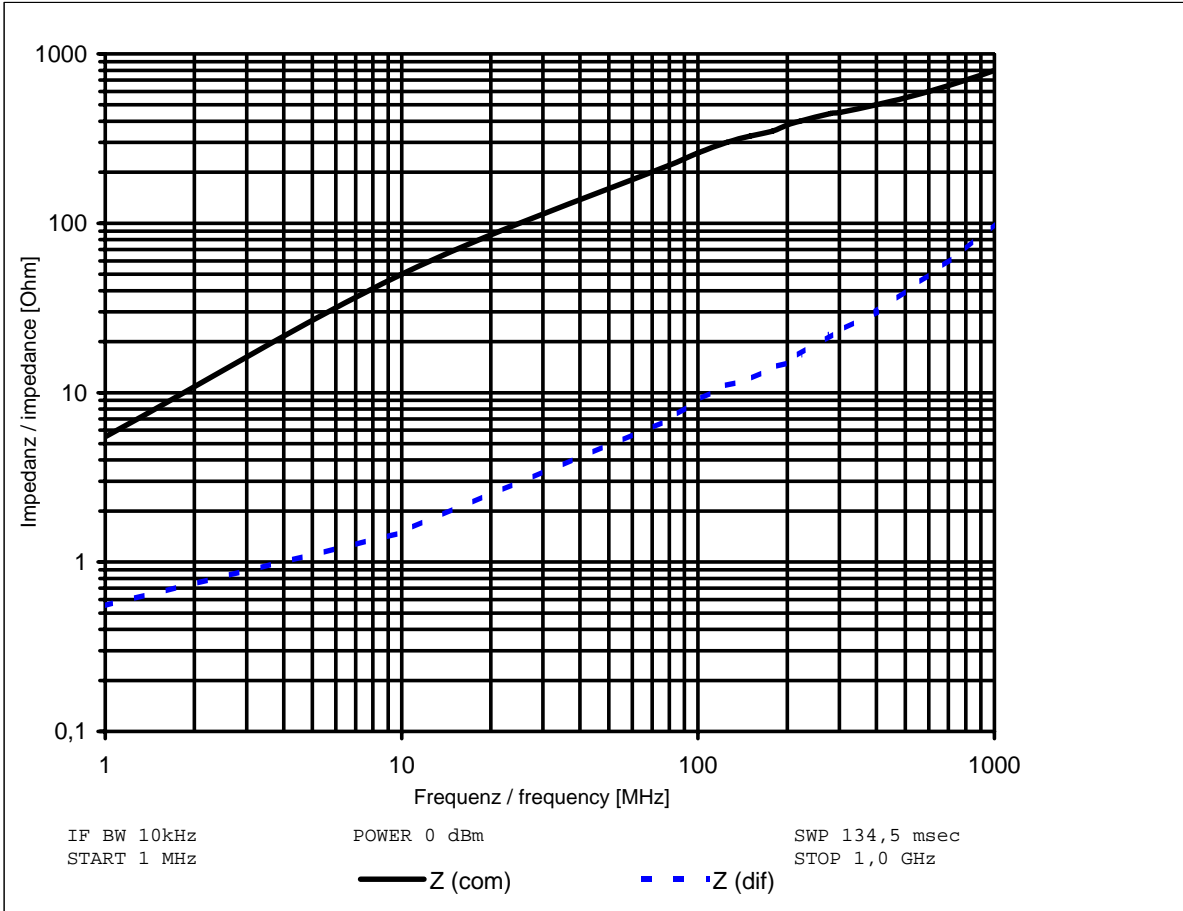

Freigabe erteilt / general release:	<b>Kunde / customer</b>			
Datum / date	Unterschrift / signature			
	<b>Würth Elektronik</b>	MST	Version 3	04-10-11
		SST	Version 2	04-02-17
Geprüft / checked	Kontrolliert / approved	MST	Version 1	03-11-25
		Name	<b>Änderung / modification</b>	Datum / date

**Würth Elektronik eiSos GmbH & Co. KG**

D-74638 Waldenburg · Max-Eyth-Strasse 1 -3 · Germany · Telefon (+49) (0) 7942 - 945 - 0 · Telefax (+49) (0) 7942 - 945 - 400  
<http://www.we-online.com>

# Spezifikation für Freigabe / specification for release

Kunde / customer : \_\_\_\_\_  
 Artikelnummer / part number : **744232261** LF  
 Bezeichnung : **SMD Stromkomp. Datenleitungsfilter WE-CNSW**  
 description : **SMD common mode noise suppressor WE-CNSW**



DATUM / DATE : 2004-10-11

## I Rollenspezifikation / tape and reel specifications:

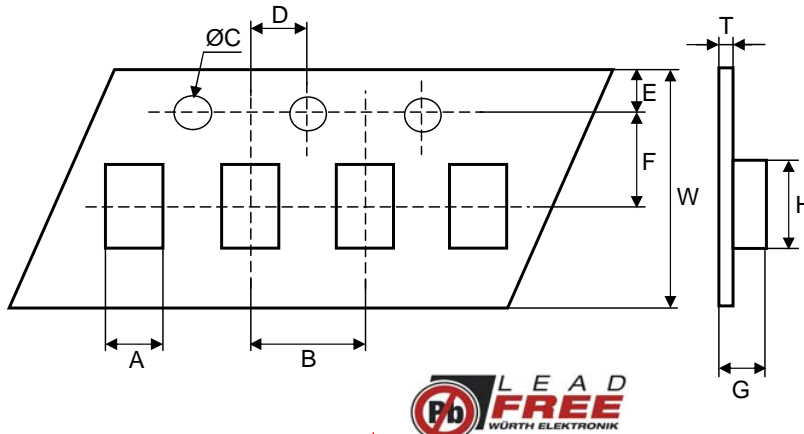

Gurtspezifikation / Tape specification:		
A	<b>1,90 ± 0,1</b>	mm
B	<b>4,00 ± 0,1</b>	mm
C	<b>1,50 ± 0,05</b>	mm
D	<b>2,00 ± 0,1</b>	mm
E	<b>1,75 ± 0,1</b>	mm
F	<b>3,50 ± 0,1</b>	mm
G	<b>2,10 ± 0,1</b>	mm
H	<b>3,50 ± 0,1</b>	mm
W	<b>8,00 ± 0,1</b>	mm
T	<b>0,23 ± 0,05</b>	mm

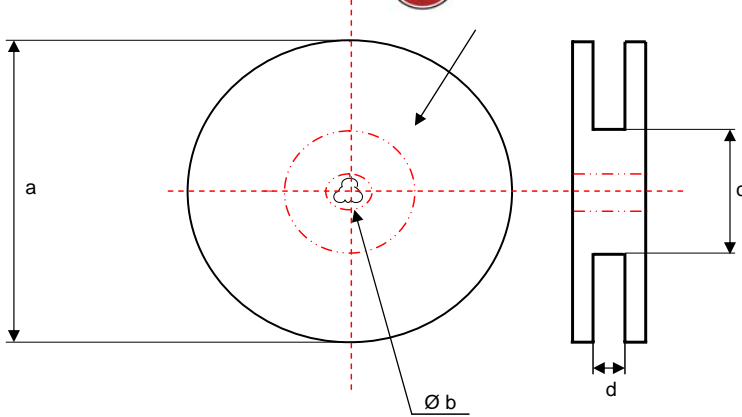

Rollenspezifikation / Reel Specification:		
a	<b>178,0 ± 0,1</b>	mm
b	<b>21,00 ± 0,1</b>	mm
c	<b>50,00 ± 0,1</b>	mm
d	<b>10,00 ± 0,1</b>	mm

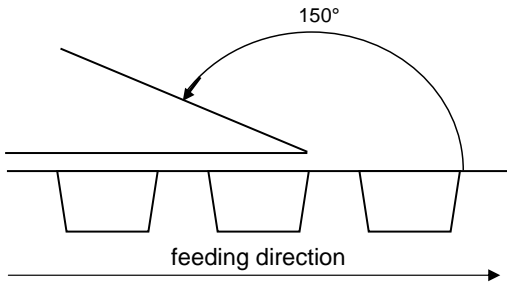

**The force of tearing off cover tape is 0,2 to 0,7 N in arrow direction.**

Freigabe erteilt / general release:	Kunde / customer		
Datum / date	Unterschrift / signature		
	Würth Elektronik		
Geprüft / checked	MST	Version 3	04-10-11
	SST	Version 2	04-02-17
	MST	Version 1	03-11-25
	Name	Änderung / modification	Datum / date

This electronic component has been designed and developed for usage in general electronic equipment. Before incorporating this component into any equipment where higher safety and reliability is especially required or if there is the possibility of direct damage or injury to human body, for example in the range of aerospace, aviation, nuclear control, submarine, transportation, (automotive control, train control, ship control), transportation signal, disaster prevention, medical, public information network etc, Würth Elektronik eiSos GmbH must be informed before the design-in stage. In addition, sufficient reliability evaluation checks for safety must be performed on every electronic component which is used in electrical circuits that require high safety and reliability functions or performance.

**Würth Elektronik eiSos GmbH & Co. KG**

D-74638 Waldenburg · Max-Eyth-Strasse 1 -3 · Germany · Telefon (+49) (0) 7942 - 945 - 0 · Telefax (+49) (0) 7942 - 945 - 400  
<http://www.we-online.com>