

Series V

Type 24V

Dimensions in mm (not to scale)

Recommended PWB piercing plan

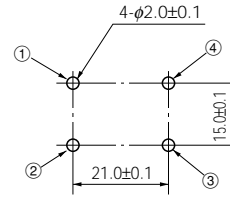
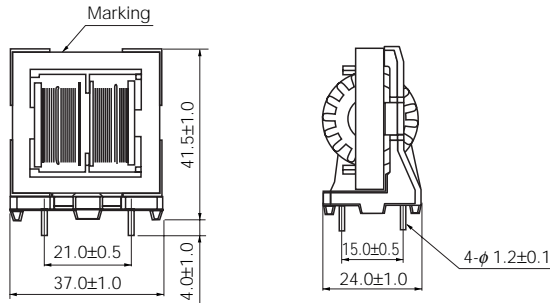

Standard Parts

| Part No. | Marking | Inductance (mH) min. | *R _{DC} (Ω) [at 20 °C] (Tol ±20 %) | Current (A rms) max. | Part No. | Marking | Inductance (mH) min. | *R _{DC} (Ω) [at 20 °C] (Tol ±20 %) | Current (A rms) max. |
|------------|---------|----------------------|---|----------------------|------------|----------|----------------------|---|----------------------|
| ELF24V008A | 823 08A | 82.00 | 0.892 | 0.8 | ELF24V034A | 562 34A | 5.60 | 0.065 | 3.4 |
| ELF24V010A | 563 10A | 56.00 | 0.608 | 1.0 | ELF24V035A | 472 35A | 4.70 | 0.060 | 3.5 |
| ELF24V012A | 473 12A | 47.00 | 0.469 | 1.2 | ELF24V037A | 392 37A | 3.90 | 0.052 | 3.7 |
| ELF24V014A | 333 14A | 33.00 | 0.327 | 1.4 | ELF24V042A | 332 42A | 3.30 | 0.041 | 4.2 |
| ELF24V015A | 273 15A | 27.00 | 0.274 | 1.5 | ELF24V045A | 272 45A | 2.70 | 0.031 | 4.5 |
| ELF24V018A | 223 18A | 22.00 | 0.237 | 1.8 | ELF24V050A | 152 50A | 1.50 | 0.028 | 5.0 |
| ELF24V019A | 183 19A | 18.00 | 0.228 | 1.9 | ELF24V070A | 801 70A | 0.80 | 0.016 | 7.0 |
| ELF24V020A | 153 20A | 15.00 | 0.161 | 2.0 | ELF24V080A | 401 80A | 0.40 | 0.015 max. | 8.0 |
| ELF24V025A | 103 25A | 10.00 | 0.124 | 2.5 | ELF24V090A | 261 90A | 0.26 | 0.012 max. | 9.0 |
| ELF24V028A | 902 28A | 9.00 | 0.100 | 2.8 | ELF24V100A | 151 100A | 0.15 | 0.0085 max. | 10.0 |
| ELF24V030A | 822 30A | 8.20 | 0.090 | 3.0 | | | | | |

* DC Resistance

Series H

Type 200

Dimensions in mm (not to scale)

Recommended PWB piercing plan

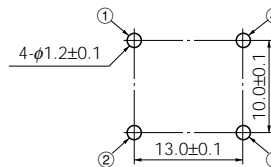
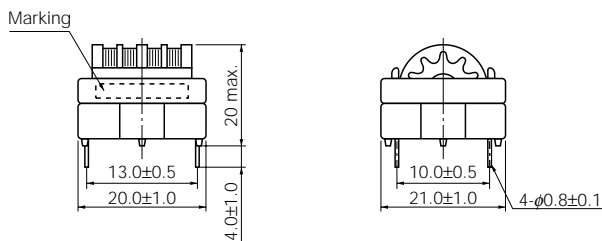

Standard Parts

| Part No. | Marking | Inductance (mH) min. | *R _{DC} (Ω) [at 20 °C] (Tol ±20 %) | Current (A rms) max. | Part No. | Marking | Inductance (mH) min. | *R _{DC} (Ω) [at 20 °C] (Tol ±20 %) | Current (A rms) max. |
|-----------|---------|----------------------|---|----------------------|------------|---------|----------------------|---|----------------------|
| ELF18D218 | ELF218 | 22.0 | 1.564 | 0.40 | ELF18D222F | ELF222F | 68.0 | 4.024 | 0.25 |
| ELF18D210 | ELF210 | 18.0 | 1.271 | 0.50 | ELF18D235F | ELF235F | 47.0 | 2.768 | 0.30 |
| ELF18D214 | ELF214 | 8.2 | 0.574 | 0.70 | ELF18D221F | ELF221F | 33.0 | 1.790 | 0.40 |
| ELF18D225 | ELF225 | 6.8 | 0.519 | 0.80 | ELF18D227F | ELF227F | 4.7 | 0.294 | 1.00 |
| ELF18D216 | ELF216 | 3.9 | 0.294 | 1.00 | ELF18D228F | ELF228F | 2.2 | 0.153 | 1.50 |
| ELF18D219 | ELF219 | 2.7 | 0.197 | 1.30 | ELF18D230F | ELF230F | 1.2 | 0.082 | 2.00 |
| ELF18D217 | ELF217 | 1.5 | 0.119 | 1.60 | ELF18D212F | ELF212F | 1.0 | 0.067 | 2.10 |

* DC Resistance

Design and specifications are each subject to change without notice. Ask factory for the current technical specifications before purchase and/or use. Should a safety concern arise regarding this product, please be sure to contact us immediately.

Feb. 2006

Series H

Type 270

Dimensions in mm (not to scale)

Recommended PWB piercing plan

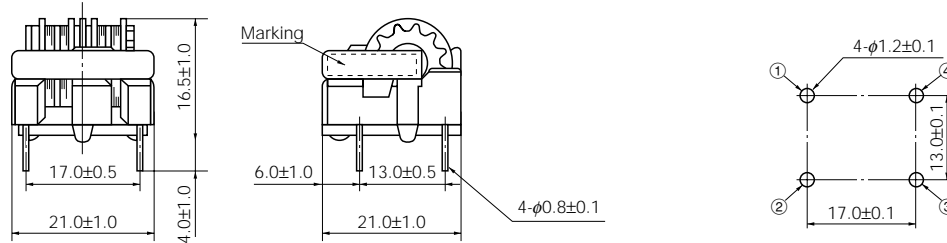

Standard Parts

| Part No. | Marking | Inductance (mH) min. | *R _{DC} (Ω) [at 20 °C] (Tol ±20 %) | Current (A rms) max. | Part No. | Marking | Inductance (mH) min. | *R _{DC} (Ω) [at 20 °C] (Tol ±20 %) | Current (A rms) max. |
|------------|---------|----------------------|---|----------------------|------------|---------|----------------------|---|----------------------|
| ELF18D270J | 270J | 33.0 | 2.691 | 0.3 | ELF18D270A | 270A | 6.8 | 0.571 | 0.7 |
| ELF18D270B | 270B | 22.0 | 1.707 | 0.4 | ELF18D270Q | 270Q | 5.6 | 0.504 | 0.8 |
| ELF18D270H | 270H | 18.0 | 1.271 | 0.5 | ELF18D270D | 270D | 2.7 | 0.248 | 1.1 |
| ELF18D270G | 270G | 10.0 | 0.782 | 0.6 | ELF18D270C | 270C | 1.8 | 0.162 | 1.5 |

* DC Resistance

Type 400

Dimensions in mm (not to scale)

Recommended PWB piercing plan

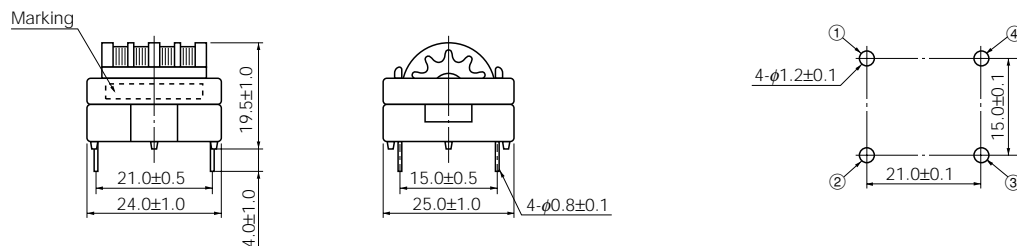

Standard Parts

| Part No. | Marking | Inductance (mH) min. | *R _{DC} (Ω) [at 20 °C] (Tol ±20 %) | Current (A rms) max. | Part No. | Marking | Inductance (mH) min. | *R _{DC} (Ω) [at 20 °C] (Tol ±20 %) | Current (A rms) max. |
|------------|---------|----------------------|---|----------------------|------------|---------|----------------------|---|----------------------|
| ELF18D428 | ELF428 | 33.00 | 1.184 | 0.5 | ELF18D427F | ELF427F | 39.00 | 1.332 | 0.5 |
| ELF18D423 | ELF423 | 27.00 | 1.136 | 0.6 | ELF18D417F | ELF417F | 18.00 | 0.655 | 0.8 |
| ELF18D430 | ELF430 | 12.00 | 0.595 | 0.9 | ELF18D431F | ELF431F | 10.00 | 0.384 | 1.0 |
| ELF18D415 | ELF415 | 8.20 | 0.374 | 1.0 | ELF18D424F | ELF424F | 5.60 | 0.191 | 1.4 |
| ELF18D412 | ELF412 | 6.80 | 0.290 | 1.2 | ELF18D434F | ELF434F | 2.70 | 0.111 | 2.0 |
| ELF18D433 | ELF433 | 3.90 | 0.176 | 1.5 | ELF18D435F | ELF435F | 2.20 | 0.084 | 2.2 |
| ELF18D414 | ELF414 | 3.30 | 0.138 | 1.8 | ELF18D420F | ELF420F | 1.20 | 0.043 | 3.0 |
| ELF18D419 | ELF419 | 1.50 | 0.076 | 2.4 | ELF18D441F | ELF441F | 0.56 | 0.030 | 3.4 |
| ELF18D437F | ELF437F | 68.00 | 2.319 | 0.4 | | | | | |

* DC Resistance

Design and specifications are each subject to change without notice. Ask factory for the current technical specifications before purchase and/or use. Should a safety concern arise regarding this product, please be sure to contact us immediately.

Series H

● Type 19H

Dimensions in mm (not to scale)

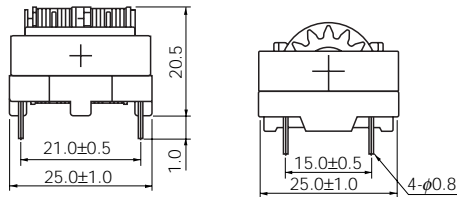

Recommended PWB piercing plan

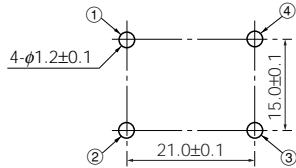

● Impedance Characteristics

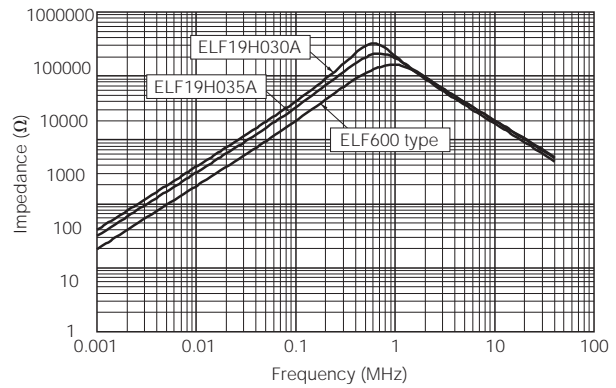

● Standard Parts (19H□□□A)

| Part No. | Marking | Inductance (mH) min. | *R _{DC} (Ω) [at 20 °C] (Tol ±20 %) | Current (A rms) max. | Part No. | Marking | Inductance (mH) min. | *R _{DC} (Ω) [at 20 °C] (Tol ±20 %) | Current (A rms) max. |
|------------|---------|----------------------|---|----------------------|------------|---------|----------------------|---|----------------------|
| ELF19H010A | 353 10A | 35.0 | 0.620 | 1.0 | ELF19H030A | 382 30A | 3.8 | 0.068 | 3.0 |
| ELF19H020A | 823 20A | 8.0 | 0.135 | 2.0 | ELF19H035A | 302 35A | 3.0 | 0.050 | 3.5 |

Series H

● Type 600

Dimensions in mm (not to scale)

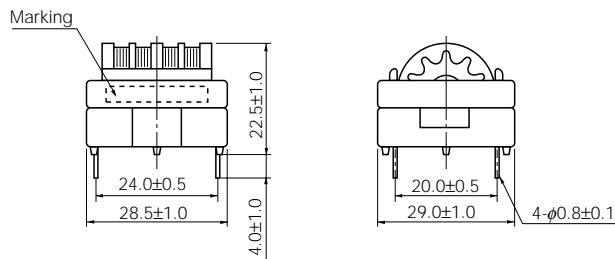

Recommended PWB piercing plan

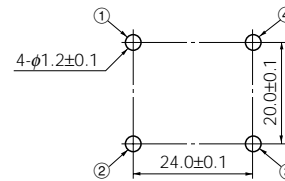

● Standard Parts

| Part No. | Marking | Inductance (mH) min. | *R _{DC} (Ω) [at 20 °C] (Tol ±20 %) | Current (A rms) max. | Part No. | Marking | Inductance (mH) min. | *R _{DC} (Ω) [at 20 °C] (Tol ±20 %) | Current (A rms) max. |
|-----------|---------|----------------------|---|----------------------|------------|---------|----------------------|---|----------------------|
| ELF18D607 | ELF607 | 68.0 | 1.739 | 0.5 | ELF18D614 | ELF614 | 1.8 | 0.062 | 2.8 |
| ELF18D615 | ELF615 | 39.0 | 1.075 | 0.7 | ELF18D610 | ELF610 | 1.5 | 0.058 | 3.1 |
| ELF18D618 | ELF618 | 27.0 | 0.708 | 0.8 | ELF18D608 | ELF608 | 1.0 | 0.045 | 3.4 |
| ELF18D612 | ELF612 | 22.0 | 0.540 | 1.0 | ELF18D624F | ELF624F | 33.0 | 0.707 | 0.8 |
| ELF18D602 | ELF602 | 8.2 | 0.226 | 1.7 | ELF18D606F | ELF606F | 18.0 | 0.331 | 1.2 |
| ELF18D603 | ELF603 | 5.6 | 0.155 | 1.8 | ELF18D609F | ELF609F | 12.0 | 0.226 | 1.6 |
| ELF18D604 | ELF604 | 4.7 | 0.125 | 2.0 | ELF18D601F | ELF601F | 10.0 | 0.214 | 1.6 |
| ELF18D613 | ELF613 | 3.9 | 0.104 | 2.2 | ELF18D603F | ELF603F | 5.6 | 0.111 | 2.2 |
| ELF18D605 | ELF605 | 3.3 | 0.087 | 2.5 | ELF18D604F | ELF604F | 4.7 | 0.087 | 2.5 |
| ELF18D611 | ELF611 | 2.7 | 0.082 | 2.6 | ELF18D617F | ELF617F | 2.2 | 0.058 | 2.8 |

* DC Resistance

Design and specifications are each subject to change without notice. Ask factory for the current technical specifications before purchase and/or use. Should a safety concern arise regarding this product, please be sure to contact us immediately.