

SM-8 BIPOLAR TRANSISTOR H-BRIDGE

ZHB6718

PRELIMINARY DATA SHEET ISSUE B - JULY 1997

FEATURES

- * Compact package
- * Low on state losses
- * Low drive requirements
- * Operates up to 20V supply
- * 2.5 Amp continuous rating

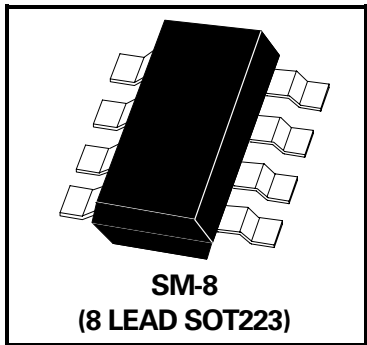

PARTMARKING DETAIL – ZHB6718

ABSOLUTE MAXIMUM RATINGS.

PARAMETER	SYMBOL	NPNs	PNPs	UNIT
Collector-Base Voltage	V_{CBO}	20	-20	V
Collector-Emitter Voltage	V_{CEO}	20	-20	V
Emitter-Base Voltage	V_{EBO}	5	-5	V
Peak Pulse Current	I_{CM}	6	-6	A
Continuous Collector Current	I_C	2.5	-2.5	A
Operating and Storage Temperature Range	$T_j; T_{stg}$	-55 to +150		°C

SCHEMATIC DIAGRAM

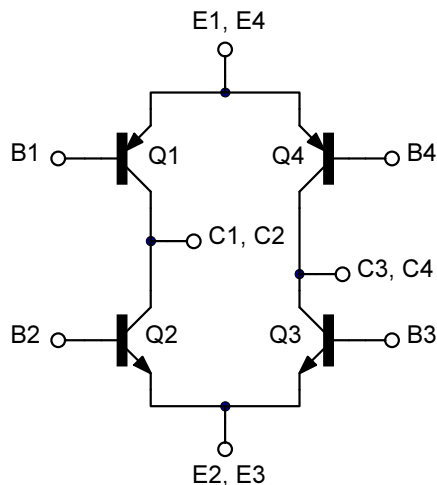

CONNECTION DIAGRAM

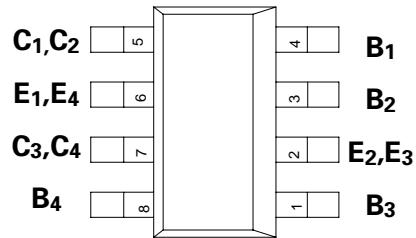

ZHB6718

THERMAL CHARACTERISTICS

PARAMETER	SYMBOL	VALUE	UNIT
Total Power Dissipation at $T_{amb} = 25^{\circ}\text{C}^*$ Any single transistor "on" Q1 and Q3 "on" or Q2 and Q4 "on" equally	P_{tot}	1.25 2	W W
Derate above 25°C^* Any single transistor "on" Q1 and Q3 "on" or Q2 and Q4 "on" equally		10 16	mW/ $^{\circ}\text{C}$ mW/ $^{\circ}\text{C}$
Thermal Resistance - Junction to Ambient* Any single transistor "on" Q1 and Q3 "on" or Q2 and Q4 "on" equally	$R_{th(j-amb)}$	100 62.5	$^{\circ}\text{C}/\text{W}$ $^{\circ}\text{C}/\text{W}$

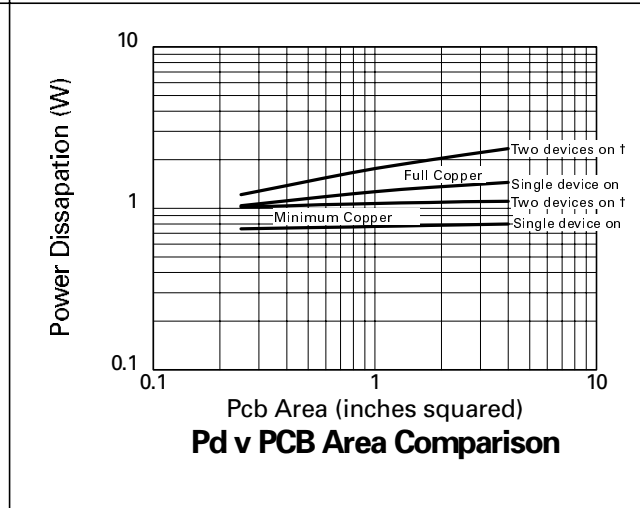
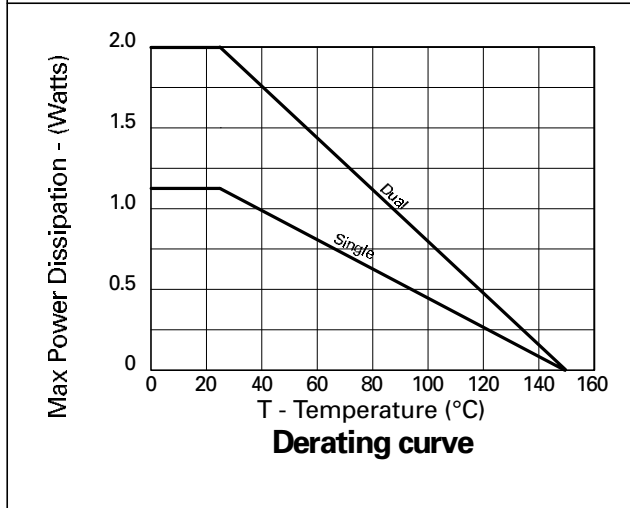
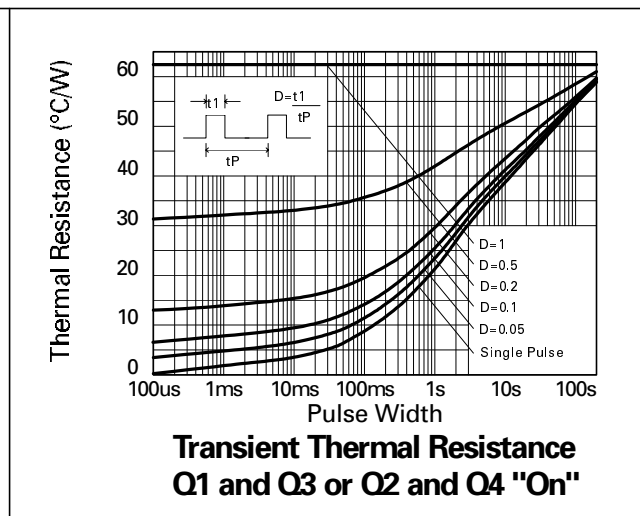
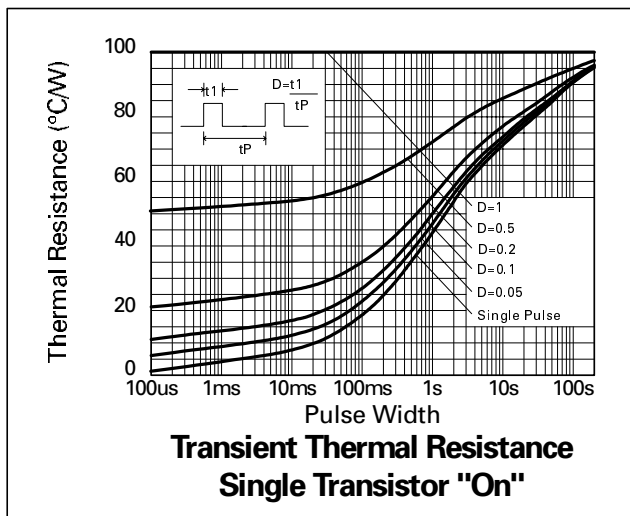

* The power which can be dissipated assuming the device is mounted in a typical manner on a PCB with copper equal to 2 inches square.

† "Two devices on" is the standard operating condition for the bridge. Eg opposing NPN/PNP pairs turned on.

ZHB6718

NPN TRANSISTORS ELECTRICAL CHARACTERISTICS (at $T_{amb} = 25^{\circ}\text{C}$).

PARAMETER	SYMBOL	MIN.	TYP.	MAX.	UNIT	CONDITIONS.
Collector-Base Breakdown Voltage	$V_{(BR)CBO}$	20	100		V	$I_C=100\mu\text{A}$
Collector-Emitter Breakdown Voltage	$V_{(BR)CEO}$	20	27		V	$I_C=10\text{mA}^*$
Emitter-Base Breakdown Voltage	$V_{(BR)EBO}$	5	8.3		V	$I_E=100\mu\text{A}$
Collector Cut-Off Current	I_{CBO}			100	nA	$V_{CB}=16\text{V}$
Emitter Cut-Off Current	I_{EBO}			100	nA	$V_{EB}=4\text{V}$
Collector Emitter Cut-Off Current	I_{CES}			100	nA	$V_{CES}=16\text{V}$
Collector-Emitter Saturation Voltage	$V_{CE(sat)}$		8 70 130	15 150 200	mV mV mV	$I_C=0.1\text{A}, I_B=10\text{mA}^*$ $I_C=1\text{A}, I_B=10\text{mA}^*$ $I_C=2.5\text{A}, I_B=50\text{mA}^*$
Base-Emitter Saturation Voltage	$V_{BE(sat)}$		0.89	1.0	V	$I_C=2.5\text{A}, I_B=50\text{mA}^*$
Base-Emitter Turn-On Voltage	$V_{BE(on)}$		0.79		V	$I_C=2.5\text{A}, V_{CE}=2\text{V}^*$
Static Forward Current Transfer Ratio	h_{FE}	200 300 200	400 450 360 180			$I_C=10\text{mA}, V_{CE}=2\text{V}^*$ $I_C=100\text{mA}, V_{CE}=2\text{V}^*$ $I_C=2\text{A}, V_{CE}=2\text{V}^*$ $I_C=6\text{A}, V_{CE}=2\text{V}^*$
Transition Frequency	f_T	100	140		MHz	$I_C=50\text{mA}, V_{CE}=10\text{V}$ $f=100\text{MHz}$
Output Capacitance	C_{obo}		23	30	pF	$V_{CB}=10\text{V}, f=1\text{MHz}$
Turn-On Time	$t_{(on)}$		170		ns	$V_{CC}=10\text{V}, I_C=1\text{A}$
Turn-Off Time	$t_{(off)}$		400		ns	$I_{B1}=-I_{B2}=10\text{mA}$

*Measured under pulsed conditions. Pulse width=300 μs . Duty cycle $\leq 2\%$.

ZHB6718

PNP TRANSISTORS ELECTRICAL CHARACTERISTICS (at $T_{amb} = 25^{\circ}\text{C}$).

PARAMETER	SYMBOL	MIN.	TYP.	MAX.	UNIT	CONDITIONS.
Collector-Base Breakdown Voltage	$V_{(BR)CBO}$	-20	-65		V	$I_C = -100\mu\text{A}$
Collector-Emitter Breakdown Voltage	$V_{(BR)CEO}$	-20	-55		V	$I_C = -10\text{mA}^*$
Emitter-Base Breakdown Voltage	$V_{(BR)EBO}$	-5	-8.8		V	$I_E = -100\mu\text{A}$
Collector Cut-Off Current	I_{CBO}			-100	nA	$V_{CB} = -15\text{V}$
Emitter Cut-Off Current	I_{EBO}			-100	nA	$V_{EB} = -4\text{V}$
Collector Emitter Cut-Off Current	I_{CES}			-100	nA	$V_{CES} = -15\text{V}$
Collector-Emitter Saturation Voltage	$V_{CE(sat)}$		-16 -130 -190	-40 -200 -260	mV mV mV	$I_C = -100\text{mA}, I_B = -10\text{mA}^*$ $I_C = -1\text{A}, I_B = -20\text{mA}^*$ $I_C = -2.5\text{A}, I_B = -200\text{mA}^*$
Base-Emitter Saturation Voltage	$V_{BE(sat)}$		-0.98	-1.1	V	$I_C = -2.5\text{A}, I_B = -200\text{mA}^*$
Base-Emitter Turn-On Voltage	$V_{BE(on)}$		0.85		V	$I_C = -2.5\text{A}, V_{CE} = -2\text{V}^*$
Static Forward Current Transfer Ratio	h_{FE}	300 300 150 35	475 450 230 70 30			$I_C = -10\text{mA}, V_{CE} = -2\text{V}^*$ $I_C = -100\text{mA}, V_{CE} = -2\text{V}^*$ $I_C = -2\text{A}, V_{CE} = -2\text{V}^*$ $I_C = -4\text{A}, V_{CE} = -2\text{V}^*$ $I_C = -6\text{A}, V_{CE} = -2\text{V}^*$
Transition Frequency	f_T	150	180		MHz	$I_C = -50\text{mA}, V_{CE} = -10\text{V}$ $f = 100\text{MHz}$
Output Capacitance	C_{obo}		21	30	pF	$V_{CB} = -10\text{V}, f = 1\text{MHz}$
Turn-On Time	$t_{(on)}$		40		ns	$V_{CC} = -10\text{V}, I_C = -1\text{A}$ $I_{B1} = I_{B2} = -20\text{mA}$
Turn-Off Time	$t_{(off)}$		670		ns	

*Measured under pulsed conditions. Pulse width=300 μs . Duty cycle $\leq 2\%$.

ZHB6718

NPN TRANSISTOR TYPICAL CHARACTERISTICS

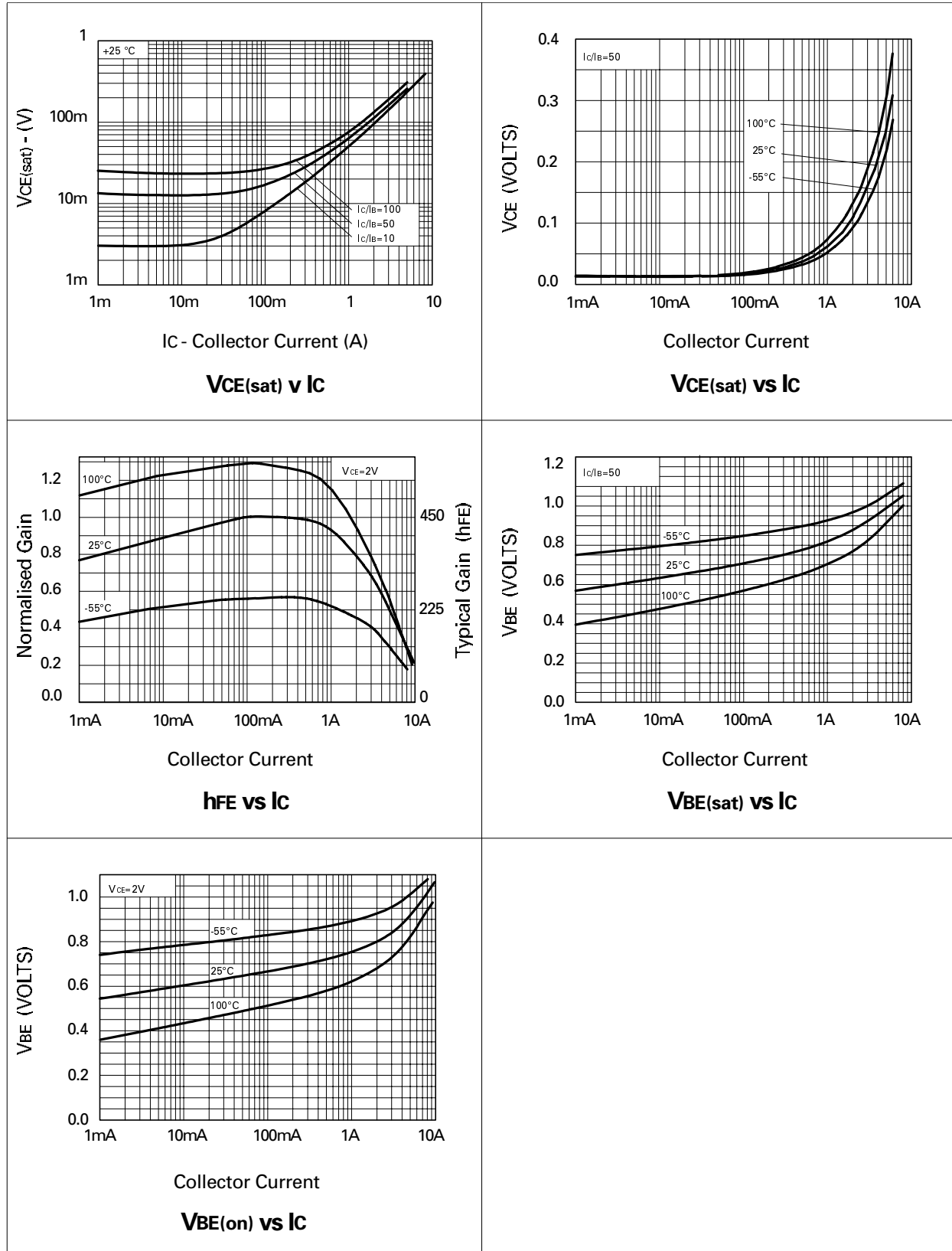

ZHB6718

PNP TRANSISTOR TYPICAL CHARACTERISTICS

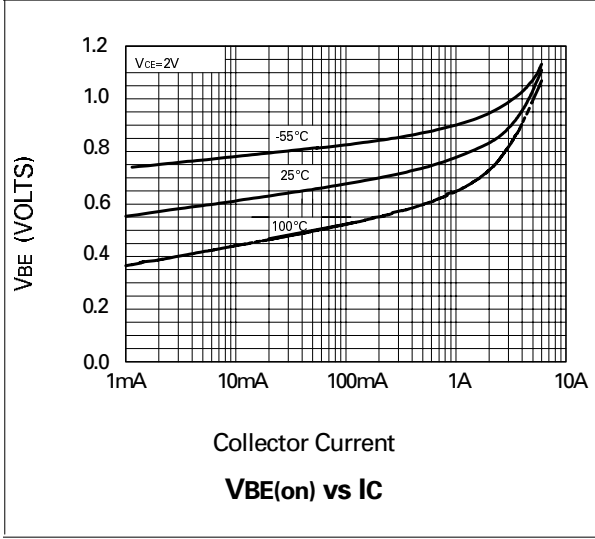
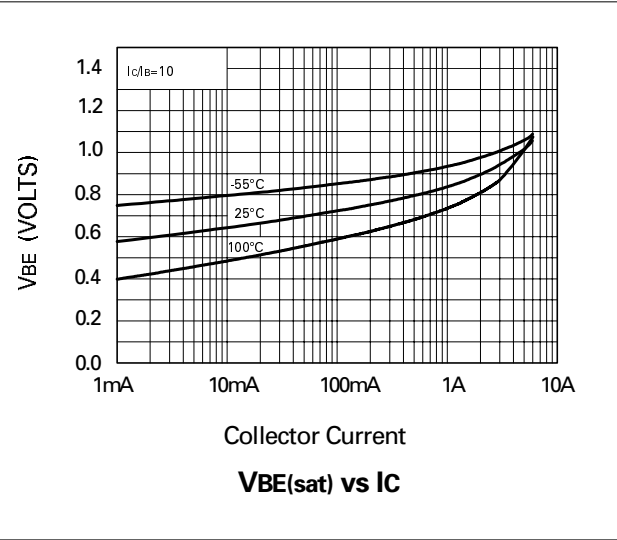
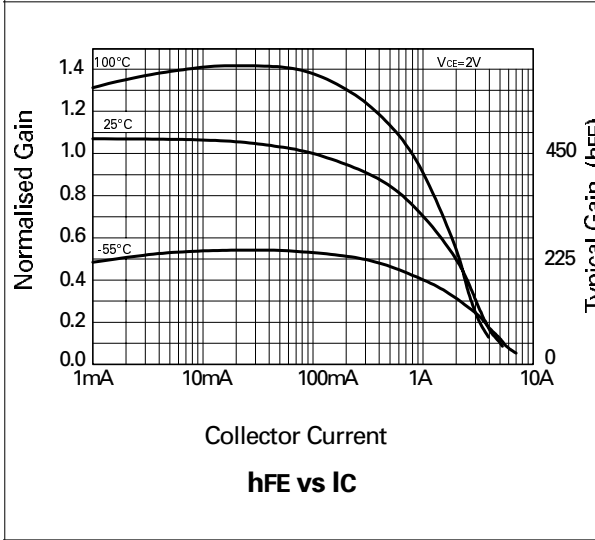
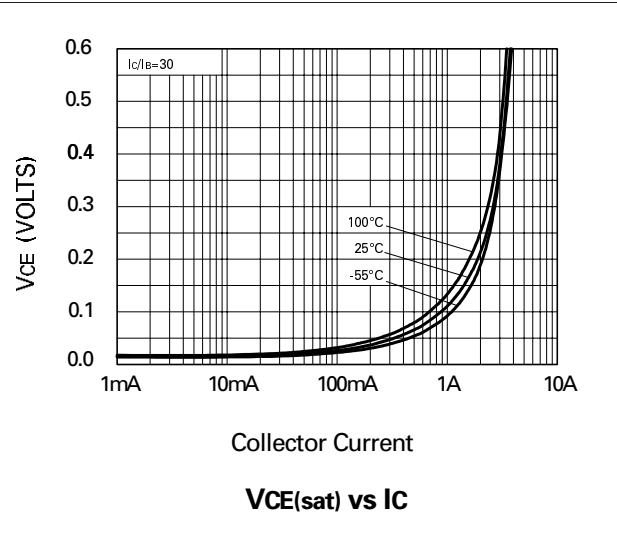
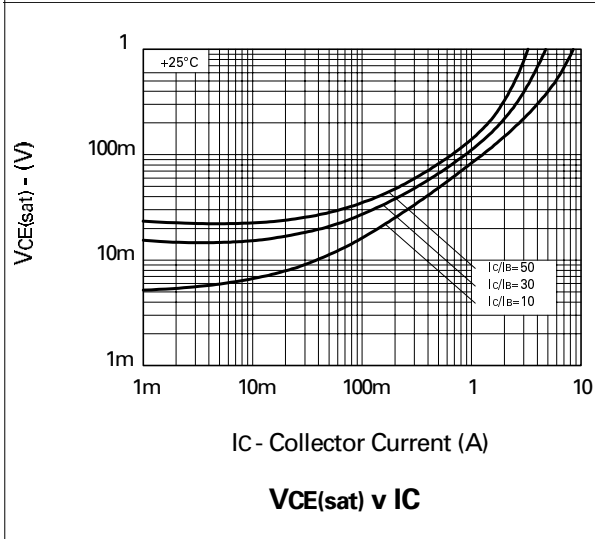

ZHB6718

SAFE OPERATING AREA

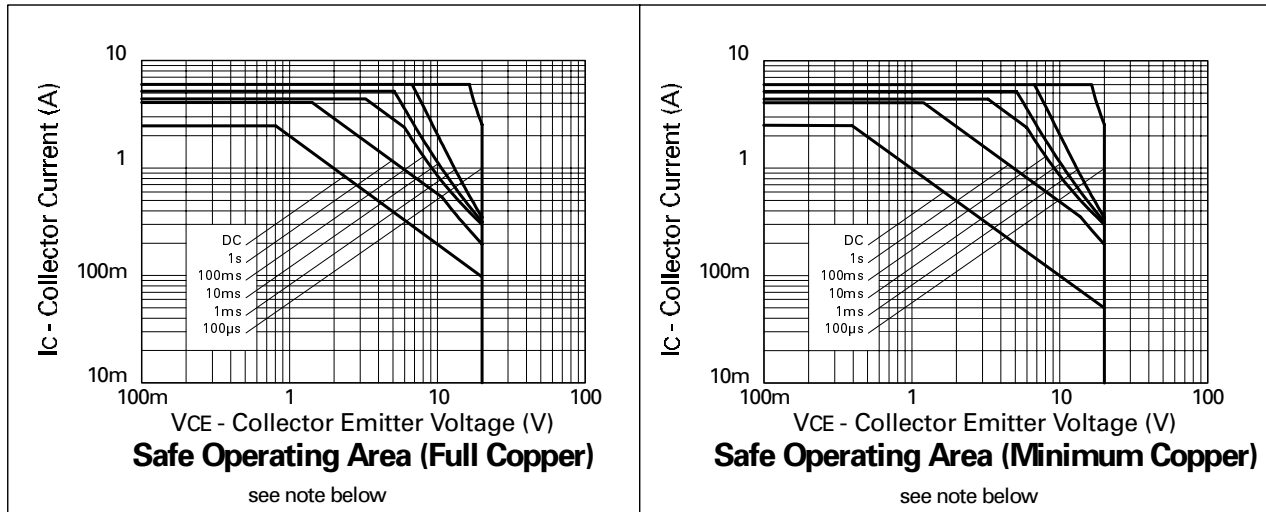

Note: The Safe Operating Area (SOA) charts shown are a combination of the worst case secondary breakdown characteristics for the NPN/PNP pair, and the thermal curves demonstrating the power dissipation capability of the energised ZHB part (opposing NPN-PNP switched on) when mounted on a 50mm x 50mm FR4 PCB. The two cases show:

- i) full copper present and
- ii) with minimal copper present - this being defined as an SM-8 footprint with 1.5mm tracks to the edge of the PCB.

For example, on a 50mm x 50mm full copper PCB, the ZHB6718 will safely dissipate 2W under DC conditions, taking note of continuous current ratings and voltage limits. Higher powers can be tolerated for pulsed operation, while the shorter pulse widths (100µs and 1ms) being relevant for assessment of switching conditions.

The ZHB6718 'H'-Bridge can be modelled within SPICE using the following transistor models configured in the standard 'H'-Bridge topology, as shown in the schematic diagram of this datasheet.

```
*ZETEX H Bridge NPN transistors Spice model Last revision 4/7/97
.MODEL H6718N NPN IS =5.611E-13 NF =1.0022 BF =480 IKF=4.6 VAF=51
+ ISE=1.73E-13 NE =1.4 NR =1.0002 BR =200 IKR=3 VAR=25
+ ISC=7.3152E-13 NC =1.47 RB =0.032 RE =0.027 RC =0.025
+ CJC=59E-12 MJC=0.2651 VJC=0.3051 CJE=216E-12
+ TF =0.95E-9 TR =2.25E-9
*
```

```
*ZETEX H Bridge PNP transistors Spice model Last revision 4/7/97
.MODEL H6718P PNP IS =6.8E-13 BF =480 IKF =2 VAF =23
+ ISE=0.8E-13 NE =1.5567 NR =1.00 BR =70 IKR=0.4
+ VAR=7 ISC=7.5E-14 NC =1.19 RB =0.085 RE =0.04
+ RC =0.045 CJC=70.02E-12 MJC=0.4685 VJC=0.7714
+ CJE=203.6E-12 MJE=0.5029 VJE=0.9403 TF =0.71E-9
+TR =23.7E-9
*
```

(C) 1997 ZETEX PLC

The copyright in these models and the design embodied belong to Zetex PLC ("Zetex"). They are supplied free of charge by Zetex for the purpose of research and design and may be used or copied intact (including this notice) for that purpose only. All other rights are reserved. The models are believed accurate but no condition or warranty as to their merchantability or fitness for purpose is given and no liability in respect of any use is accepted by Zetex PLC, its distributors or agents. Zetex PLC, Fields New Road, Chadderton, Oldham OL9 8NP, UK.

ZHB6718

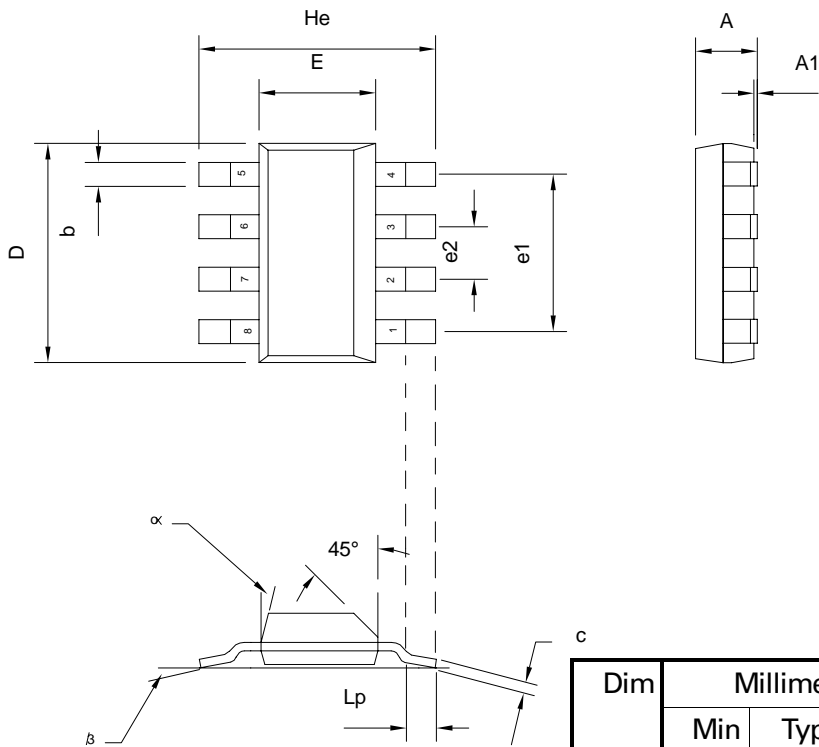

Dim	Millimetres			Inches		
	Min	Typ	Max	Min	Typ	Max
A	-	-	1.7	-	-	0.067
A1	0.02	-	0.1	0.0008	-	0.004
b	-	0.7	-	-	0.028	-
c	0.24	-	0.32	0.009	-	0.013
D	6.3	-	6.7	0.248	-	0.264
E	3.3	-	3.7	0.130	-	0.145
e1	-	4.59	-	-	0.180	-
e2	-	1.53	-	-	0.060	-
He	6.7	-	7.3	0.264	-	0.287
Lp	0.9	-	-	0.035	-	-
alpha	-	-	15°	-	-	15°
beta	-	10°	-	-	10°	-



Zetex plc.
 Fields New Road, Chadderton, Oldham, OL9-8NP, United Kingdom.
 Telephone: (44)161 622 4422 (Sales), (44)161 622 4444 (General Enquiries)
 Fax: (44)161 622 4420

Zetex GmbH
 Streitfeldstraße 19
 D-81673 München
 Germany
 Telefon: (49) 89 45 49 49 0
 Fax: (49) 89 45 49 49 49

Zetex Inc.
 47 Mall Drive, Unit 4
 Commack NY 11725
 USA
 Telephone: (516) 543-7100
 Fax: (516) 864-7630

Zetex (Asia) Ltd.
 3510 Metroplaza, Tower 2
 Hing Fong Road,
 Kwai Fong, Hong Kong
 Telephone: (852) 26100 611
 Fax: (852) 24250 494

These are supported by
 agents and distributors in
 major countries world-wide
 ©Zetex plc 1997
Internet:
<http://www.zetex.com>

This publication is issued to provide outline information only which (unless agreed by the Company in writing) may not be used, applied or reproduced for any purpose or form part of any order or contract or be regarded as a representation relating to the products or services concerned. The Company reserves the right to alter without notice the specification, design, price or conditions of supply of any product or service.