

Features

- N-Channel MOSFET and PNP Transistor in One Package
- Low On-Resistance
- Very Low Gate Threshold Voltage, 1.0V max
- Low Input Capacitance
- Fast Switching Speed
- Low Input/Output Leakage
- Ultra-Small Surface Mount Package
- **Lead, Halogen and Antimony Free, RoHS Compliant (Note 2)**
- **ESD Protected MOSFET Gate up to 2kV**
- **"Green" Device (Note 3)**
- **Qualified to AEC-Q101 Standards for High Reliability**

Mechanical Data

- Case: SOT-563
- Case Material: Molded Plastic, "Green" Molding Compound. UL Flammability Classification Rating 94V-0
- Moisture Sensitivity: Level 1 per J-STD-020
- Terminal Connections: See Diagram
- Terminals: Finish - Matte Tin annealed over Copper lead frame. Solderable per MIL-STD-202, Method 208
- Marking Information: See Page 5
- Ordering Information: See Page 5
- Weight: 0.006 grams (approximate)

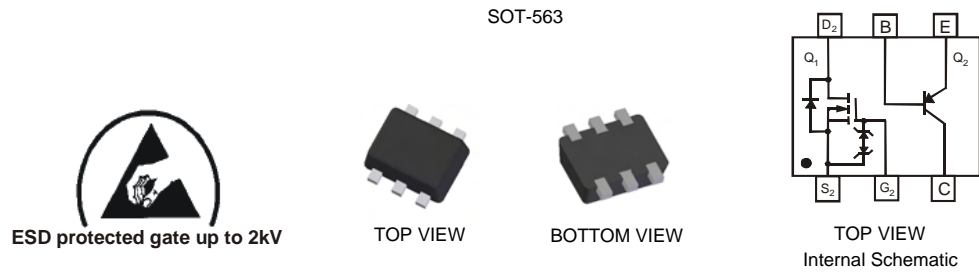

Maximum Ratings – MOSFET, Q1 @ $T_A = 25^\circ\text{C}$ unless otherwise specified

Characteristic	Symbol	Value	Units
Drain-Source Voltage	V_{DSS}	50	V
Gate-Source Voltage	V_{GSS}	± 12	V
Drain Current (Note 1)	I_D	160	mA
Pulsed Drain Current (Note 1)	I_{DM}	560	mA

Maximum Ratings - PNP Transistor, Q2 @ $T_A = 25^\circ\text{C}$ unless otherwise specified

Characteristic	Symbol	Value	Unit
Collector-Base Voltage	V_{CBO}	-50	V
Collector-Emitter Voltage	V_{CEO}	-45	V
Emitter-Base Voltage	V_{EBO}	-5.0	V
Collector Current	I_C	-100	mA

Thermal Characteristics, Total Device @ $T_A = 25^\circ\text{C}$ unless otherwise specified

Characteristic	Symbol	Value	Unit
Total Power Dissipation (Note 1)	P_D	250	mW
Thermal Resistance, Junction to Ambient (Note 1)	$R_{\theta JA}$	500	$^\circ\text{C}/\text{W}$
Operating and Storage Temperature Range	T_J, T_{STG}	-55 to +150	$^\circ\text{C}$

- Notes:
1. Device mounted on FR-4 PCB, 1 inch x 0.85 inch x 0.062 inch; pad layout as shown on Diodes Inc. suggested pad layout document AP02001, which can be found on our website at <http://www.diodes.com/datasheets/ap02001.pdf>.
 2. No purposefully added lead. Halogen and Antimony Free.
 3. Diodes Inc.'s "Green" policy can be found on our website at http://www.diodes.com/products/lead_free/index.php.

Electrical Characteristics - MOSFET @ $T_A = 25^\circ\text{C}$ unless otherwise specified

Characteristic	Symbol	Min	Typ	Max	Unit	Test Condition
OFF CHARACTERISTICS (Note 2)						
Drain-Source Breakdown Voltage	BV_{DSS}	50	—	—	V	$V_{GS} = 0V, I_D = 250\mu A$
Zero Gate Voltage Drain Current	I_{DSS}	—	—	10	μA	$V_{DS} = 50V, V_{GS} = 0V$
Gate-Body Leakage	I_{GSS}	—	—	1.0 5.0	μA	$V_{GS} = \pm 8V, V_{DS} = 0V$ $V_{GS} = \pm 12V, V_{DS} = 0V$
ON CHARACTERISTICS (Note 2)						
Gate Threshold Voltage	$V_{GS(th)}$	0.7	0.8	1.0	V	$V_{DS} = V_{GS}, I_D = 250\mu A$
Static Drain-Source On-Resistance	$R_{DS(ON)}$	—	3.1	4	Ω	$V_{GS} = 4V, I_D = 100mA$
		—	4	5		$V_{GS} = 2.5V, I_D = 80mA$
Forward Transconductance	g_{FS}	180	—	—	mS	$V_{DS} = 10V, I_D = 100mA,$ $f = 1.0KHz$
DYNAMIC CHARACTERISTICS						
Input Capacitance	C_{iss}	—	25	—	pF	$V_{DS} = 10V, V_{GS} = 0V,$ $f = 1.0MHz$
Output Capacitance	C_{oss}	—	5	—	pF	
Reverse Transfer Capacitance	C_{rss}	—	2.1	—	pF	

Electrical Characteristics - PNP Transistor @ $T_A = 25^\circ\text{C}$ unless otherwise specified

Characteristic	Symbol	Min	Typ	Max	Unit	Test Condition
Collector-Base Breakdown Voltage (Note 4)	$V_{(BR)CBO}$	-50	—	—	V	$I_C = 10\mu A, I_B = 0$
Collector-Emitter Breakdown Voltage (Note 4)	$V_{(BR)CEO}$	-45	—	—	V	$I_C = 10mA, I_B = 0$
Emitter-Base Breakdown Voltage (Note 4)	$V_{(BR)EBO}$	-5	—	—	V	$I_E = 1\mu A, I_C = 0$
DC Current Gain (Note 4)	h_{FE}	220	290	475	—	$V_{CE} = -5.0V, I_C = -2.0mA$
Collector-Emitter Saturation Voltage (Note 4)	$V_{CE(SAT)}$	—	—	-100	mV	$I_C = -10mA, I_B = -0.5mA$
		—	—	-400		$I_C = -100mA, I_B = -5.0mA$
Base-Emitter Saturation Voltage (Note 4)	$V_{BE(SAT)}$	—	-700	—	mV	$I_C = -10mA, I_B = -0.5mA$
		—	-900	—		$I_C = -100mA, I_B = -5.0mA$
Base-Emitter Voltage (Note 4)	$V_{BE(ON)}$	-600	—	-750	mV	$V_{CE} = -5.0V, I_C = -2.0mA$
		—	—	-820		$V_{CE} = -5.0V, I_C = -10mA$
Collector-Cutoff Current (Note 4)	I_{CBO}	—	—	-15	nA	$V_{CB} = -30V$
		—	—	-4.0	μA	$V_{CB} = -30V, T_A = 150^\circ C$
Collector-Emitter Cut-Off Current (Note 4)	I_{CES}	—	—	-100	nA	$V_{CE} = -45V$
Gain Bandwidth Product	f_T	100	—	—	MHz	$V_{CE} = -5.0V, I_C = -10mA, f = 100MHz$
Output Capacitance	C_{OB}	—	—	4.5	pF	$V_{CB} = -10V, f = 1.0MHz$
Noise Figure	NF	—	—	10	dB	$I_C = -0.2mA, V_{CE} = -5.0V_{dc},$ $R_S = 2.0K\Omega, f = 1.0KHz, BW = 200Hz$

Notes: 4. Short duration pulse test used to minimize self-heating effect.

MOSFET

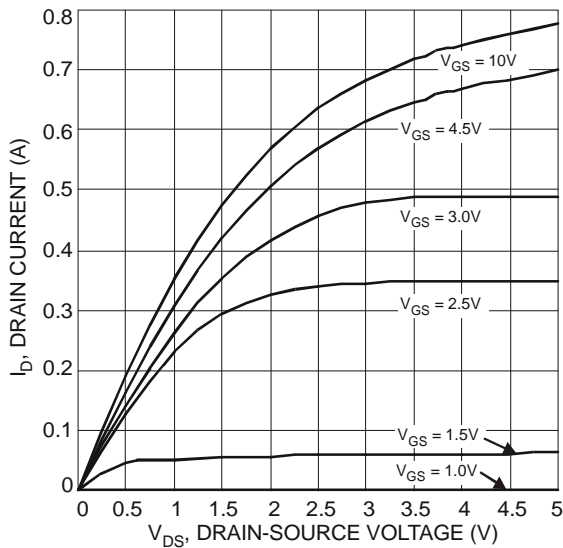

Fig. 1 Typical Output Characteristics

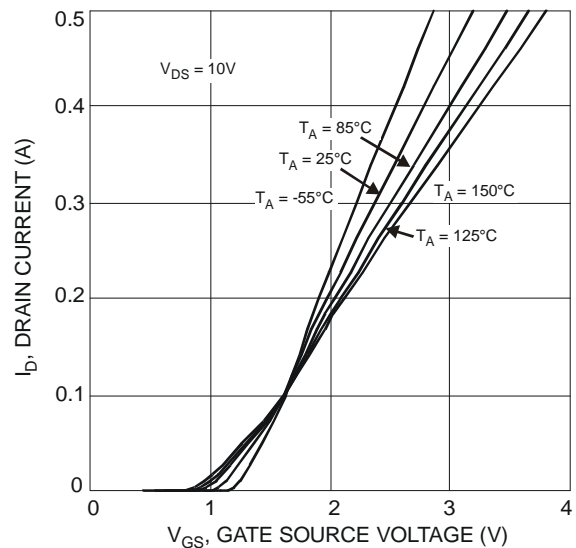

Fig. 2 Typical Transfer Characteristics

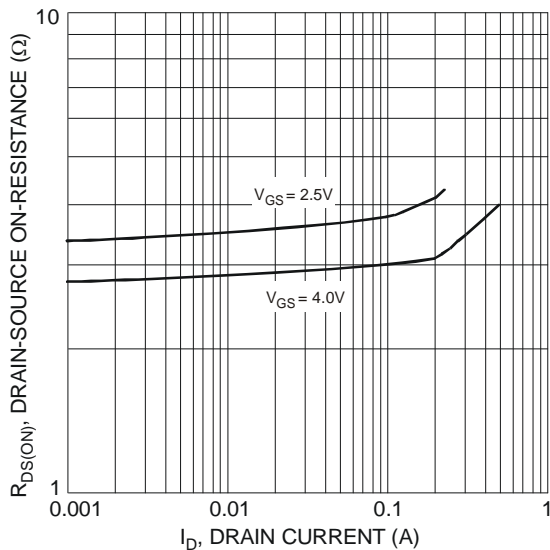

Fig. 3 Typical On-Resistance vs. Drain Current and Gate Voltage

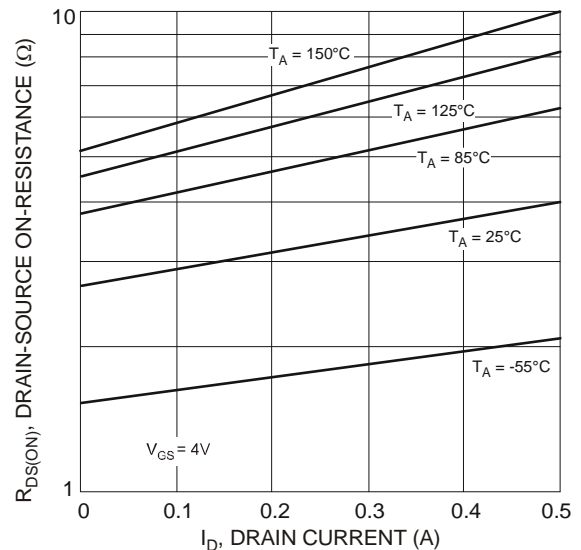

Fig. 4 Typical Drain-Source On-Resistance vs. Drain Current and Temperature

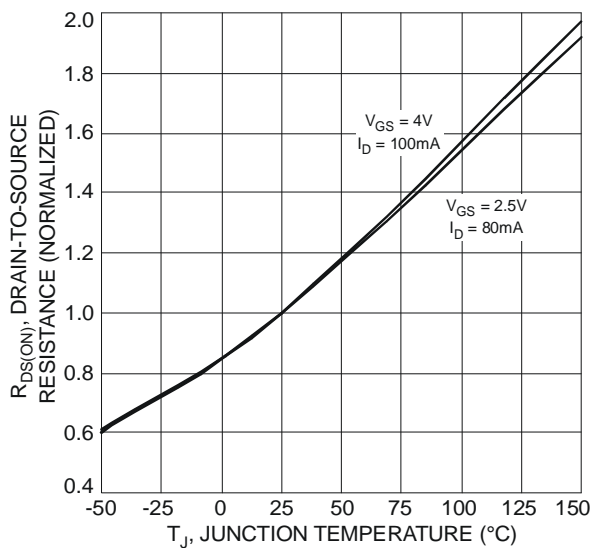

Fig. 5 On-Resistance Variation with Temperature

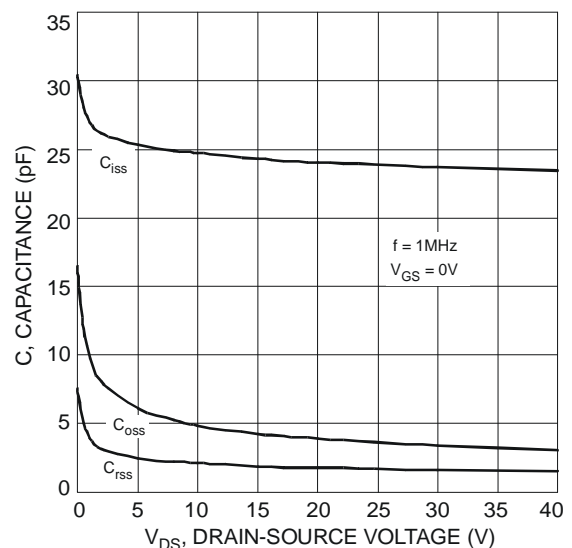

Fig. 6 Typical Capacitance

MOSFET (continued)

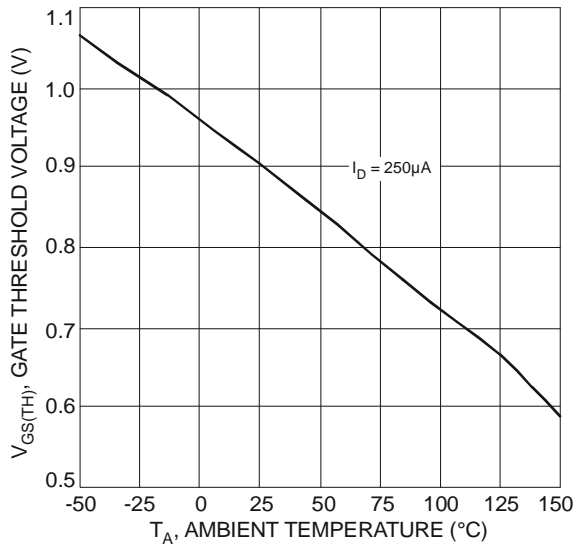

Fig. 7 Gate Threshold Variation vs. Ambient Temperature

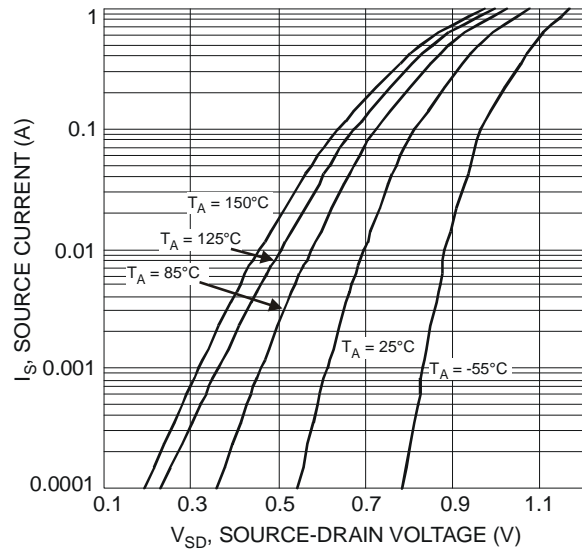

Fig. 8 Diode Forward Voltage vs. Current

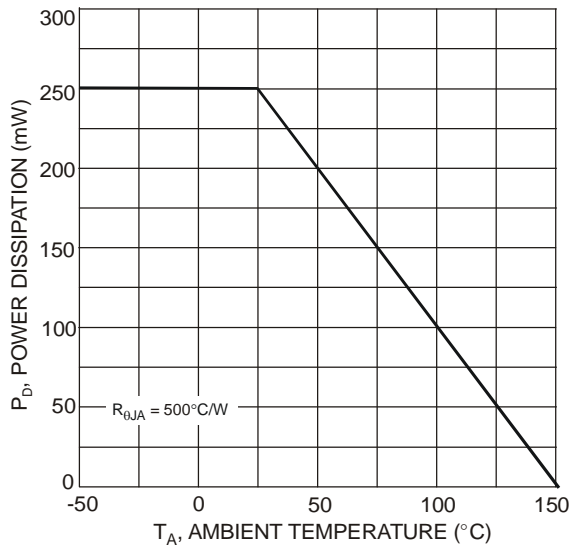

Fig. 9 Derating Curve - Total Package Power Dissipation

PNP Transistor

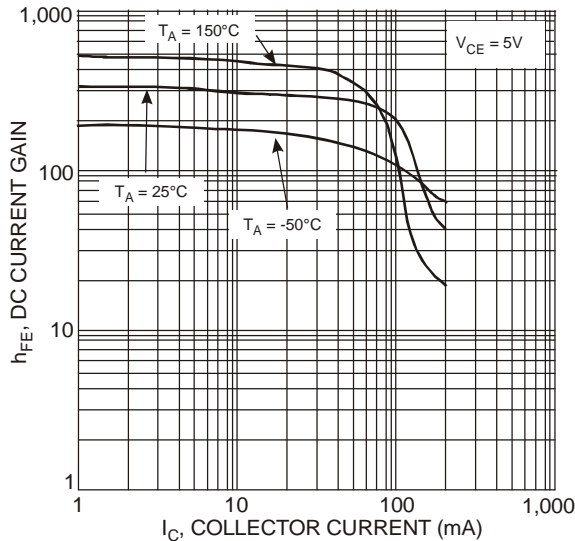

Fig. 10 Typical DC Current Gain vs. Collector Current

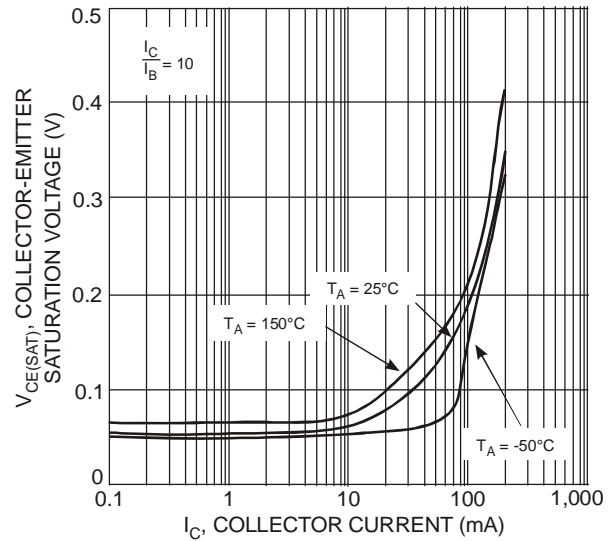

Fig. 11 Collector-Emitter Saturation Voltage vs. Collector Current

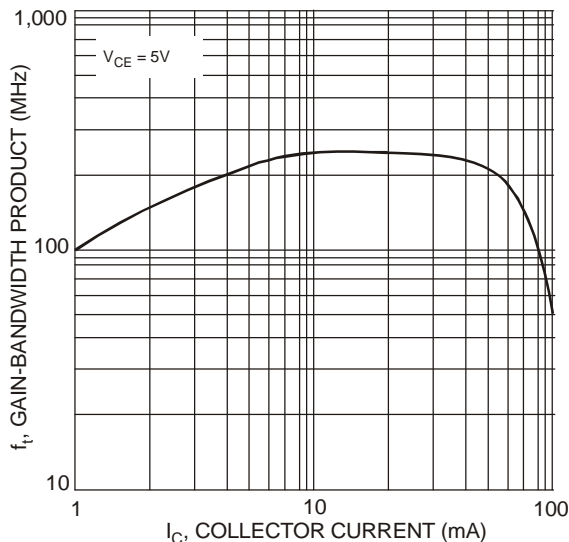

Fig. 12 Typical Gain-Bandwidth Product vs. Collector Current

Ordering Information (Note 5)

Part Number	Case	Packaging
DMB54D0UV-7	SOT-563	3000/Tape & Reel

Notes: 5. For packaging details, go to our website at <http://www.diodes.com/datasheets/ap02007.pdf>.

Marking Information

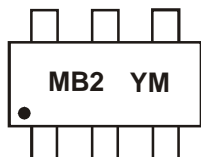

MB2 = Marking Code
YM = Date Code Marking
Y = Year (ex: V = 2008)
M = Month (ex: 9 = September)

Date Code Key

Year	2008	2009	2010	2011	2012	2013	2014	2015
Code	V	W	X	Y	Z	A	B	C

Month	Jan	Feb	Mar	Apr	May	Jun	Jul	Aug	Sep	Oct	Nov	Dec
Code	1	2	3	4	5	6	7	8	9	O	N	D

Package Outline Dimensions

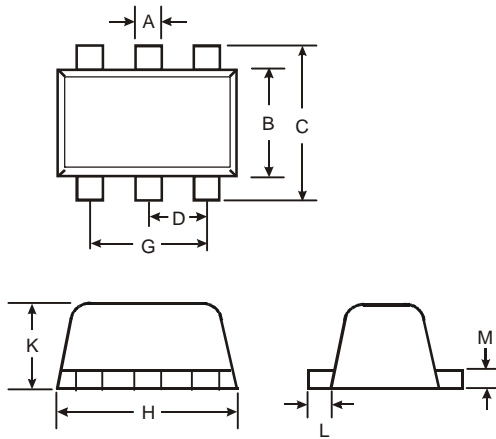

SOT-563			
Dim	Min	Max	Typ
A	0.15	0.30	0.20
B	1.10	1.25	1.20
C	1.55	1.70	1.60
D	-	-	0.50
G	0.90	1.10	1.00
H	1.50	1.70	1.60
K	0.55	0.60	0.60
L	0.10	0.30	0.20
M	0.10	0.18	0.11
All Dimensions in mm			

Suggested Pad Layout

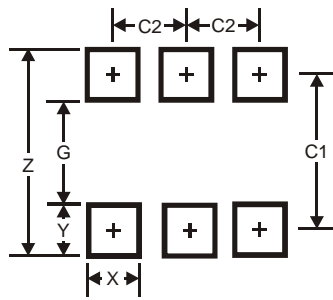

Dimensions	Value (in mm)
Z	2.2
G	1.2
X	0.375
Y	0.5
C1	1.7
C2	0.5

IMPORTANT NOTICE

DIODES INCORPORATED MAKES NO WARRANTY OF ANY KIND, EXPRESS OR IMPLIED, WITH REGARDS TO THIS DOCUMENT, INCLUDING, BUT NOT LIMITED TO, THE IMPLIED WARRANTIES OF MERCHANTABILITY AND FITNESS FOR A PARTICULAR PURPOSE (AND THEIR EQUIVALENTS UNDER THE LAWS OF ANY JURISDICTION).

Diodes Incorporated and its subsidiaries reserve the right to make modifications, enhancements, improvements, corrections or other changes without further notice to this document and any product described herein. Diodes Incorporated does not assume any liability arising out of the application or use of this document or any product described herein; neither does Diodes Incorporated convey any license under its patent or trademark rights, nor the rights of others. Any Customer or user of this document or products described herein in such applications shall assume all risks of such use and will agree to hold Diodes Incorporated and all the companies whose products are represented on Diodes Incorporated website, harmless against all damages.

Diodes Incorporated does not warrant or accept any liability whatsoever in respect of any products purchased through unauthorized sales channel. Should Customers purchase or use Diodes Incorporated products for any unintended or unauthorized application, Customers shall indemnify and hold Diodes Incorporated and its representatives harmless against all claims, damages, expenses, and attorney fees arising out of, directly or indirectly, any claim of personal injury or death associated with such unintended or unauthorized application.

Products described herein may be covered by one or more United States, international or foreign patents pending. Product names and markings noted herein may also be covered by one or more United States, international or foreign trademarks.

LIFE SUPPORT

Diodes Incorporated products are specifically not authorized for use as critical components in life support devices or systems without the express written approval of the Chief Executive Officer of Diodes Incorporated. As used herein:

A. Life support devices or systems are devices or systems which:

1. are intended to implant into the body, or
2. support or sustain life and whose failure to perform when properly used in accordance with instructions for use provided in the labeling can be reasonably expected to result in significant injury to the user.

B. A critical component is any component in a life support device or system whose failure to perform can be reasonably expected to cause the failure of the life support device or to affect its safety or effectiveness.

Customers represent that they have all necessary expertise in the safety and regulatory ramifications of their life support devices or systems, and acknowledge and agree that they are solely responsible for all legal, regulatory and safety-related requirements concerning their products and any use of Diodes Incorporated products in such safety-critical, life support devices or systems, notwithstanding any devices- or systems-related information or support that may be provided by Diodes Incorporated. Further, Customers must fully indemnify Diodes Incorporated and its representatives against any damages arising out of the use of Diodes Incorporated products in such safety-critical, life support devices or systems.

Copyright © 2009, Diodes Incorporated

www.diodes.com