

SPECIFICATION FOR APPROVAL

CUSTOMER :
 DESCRIPTION : DC BRUSHLESS FAN
 DIMENSIONS : 35X35X10 mm
 MODEL : KDE1235PFB2-8
 APPROVED NO :
 APPROVED BY :
 (AUTHORIZED)

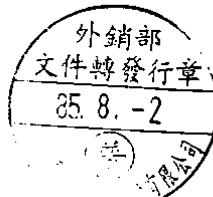

DAWN.	6/5	CHKD.	6/5	APPD.		SPEC. NO.	132-429300
						ISSUE DATE	06.05.1996
						EDITION	0
						REVISE DATE	

建準電機工業股份有限公司
 SUNONWEALTH ELECTRIC MACHINE INDUSTRY CO., LTD.
 12FL., 120 CHUNG CHENG 1ST RD., TEL:886-7-7163069
 KAOHSIUNG, TAIWAN, R. O. C. FAX:886-7-7163086-89

DC BRUSHLESS FAN

MODEL:KDE1235PFB2-8

CHARACTERISTICS

1. Motor Design : Patented single-coil DC brushless 8 poles motor design.
2. Insulation Resistance : More than 500M ohm between internal stator and lead wire(+) measured by DC 500V.
3. Dielectric Strength : Applied AC 500V for one minute or AC 600V for 2 seconds between housing and lead wire(+)
4. Noise Level : Measured in an semi-anechoic chamber with background noise level below 15 dBA. The fan is running in free air with microphone at a distance of one meter from the fan intake.
5. Input power , Current & Speed : Measured after continuous 30 minutes operation at rated voltage in clean air at ambient temperature of 25 degrees C.
6. Tolerances : $\pm 5\%$ on rated power and current
7. Motor Protection : Polarity protected & Locked rotor protected.
8. Air Performance : Measured by a double chamber. The value are recorded when the fan speed is stabilized at rated voltage.

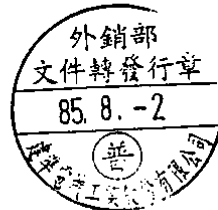

建準電機工業股份有限公司 SUNONWEALTH ELECTRIC MACHINE INDUSTRY CO., LTD	SPEC. NO.	132429300	REVISE DATE	
	ISSUE DATE	06.05.1996	EDITION	0
	PAGE	2 OF 6		

SPECIFICATIONS

MODEL:KDE1235PFB2-8

1-1. Rated Voltage	:	12 VDC
1-2. Operating Voltage Range	:	10.2-13.8 VDC
1-3. Starting Voltage	:	10 VDC
1-4. Speed (Reference Value)	:	6000 RPM
1-5. Air Delivery	:	4.5 CFM
1-6. Static Pressure	:	0.08 Inch-H ₂ O
1-7. Rated Current	:	0.07 AMP
1-8. Rated Power	:	0.84 WATTS
1-9. Noise Level	:	21 dB(A)
1-10. Direction of Rotation	:	Clockwies viewed from front face
1-11. Operating Temperature	:	-10 to +70 Deg.C
1-12. Storage Temperature	:	-40 to +70 Deg.C
1-13. Bearing System	:	Precise ball bearing system
1-14. Weight	:	9g

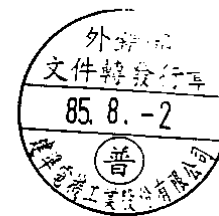
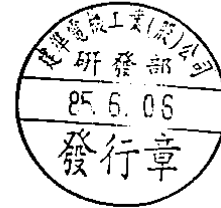

建準電機工業股份有限公司 SUNONWEALTH ELECTRIC MACHINE INDUSTRY CO., LTD.	SPEC. NO.	132429300	REVISE DATE	
	ISSUE DATE	06.05.1996	EDITION	0
	PAGE	3 OF 6		

MODEL:KDE1235PFB2-8

PERFORMANCE CURVES

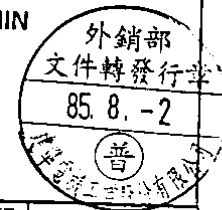
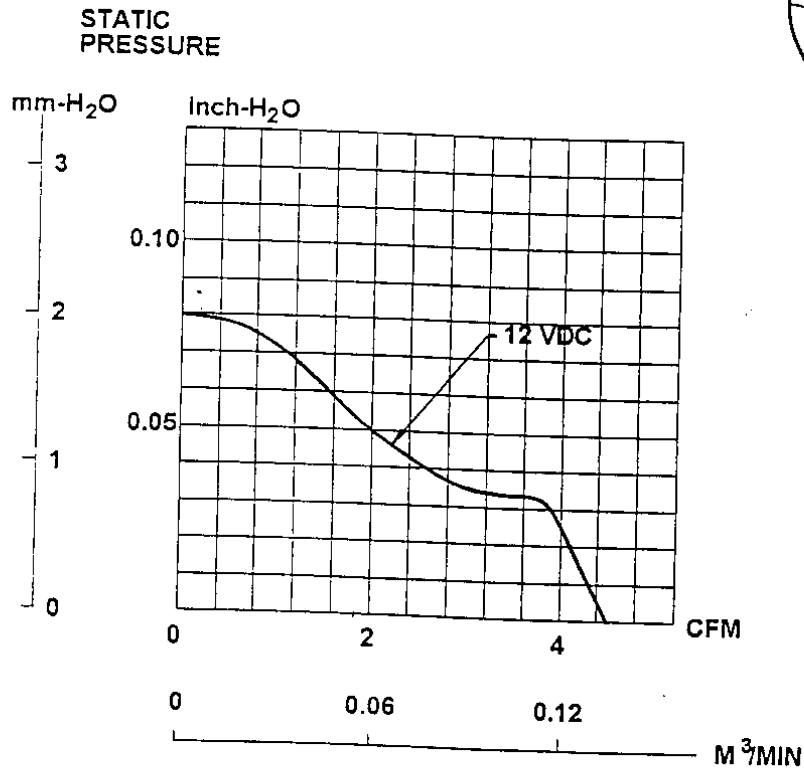

建準電機工業股份有限公司 SUNONWEALTH ELECTRIC MACHINE INDUSTRY CO., LTD.	SPEC. NO.	132429300	REVISE DATE	
	ISSUE DATE	06. 05. 1996	EDITION	0
	PAGE	4 OF 6		

MATERIAL

- 2-1. Frame : Thermoplastic PBT of UL 94V-0
- 2-2. Impeller : Thermoplastic PBT of UL 94V-0
- 2-3. Bobbin : Thermoplastic PBT of UL 94V-0
- 2-4. Lead Wire : UL1571, 28AWG, +:RED ; -:BLACK

DIMENSIONS

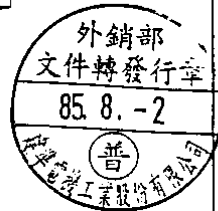
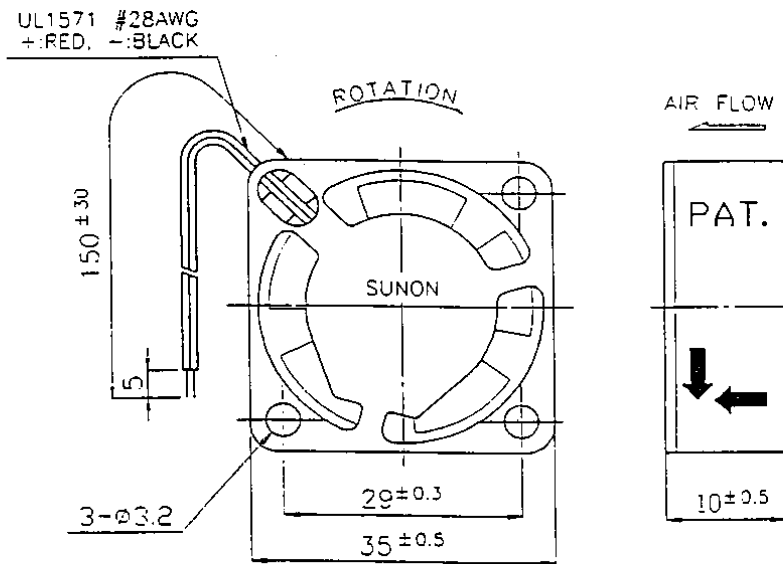

UNIT : mm

建準電機工業股份有限公司 SUNONWEALTH ELECTRIC MACHINE INDUSTRY CO., LTD.	SPEC. NO.	132429300	REVISE DATE	
	ISSUE DATE	06. 05. 1996	EDITION	0
	PAGE	5 OF 6		

Notes



1. SUNON will not guarantee the products if the application of our products is exceeded the limitation which is specified on this specification.
2. In case of change of the specification specified on this document, a written notice is requested in advance.
3. Please do not touch the impeller with pressure and never bring the fan with lead wire. The bearings and lead wire may be damaged.
4. No guarantee on the products against the safety problem or failure caused by powder dust, drop of water or insect.
5. If there is any data or related documentation different from this data sheet, this data sheet is the principal reference.
6. For the purpose of MIS, please indicate SPEC No. on every order.
7. In case of the fan has no polarity protection function, wires with same color (electrode) must be connected together during the assembly. (i.e. red+red, black+black)

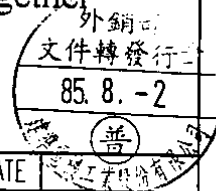

建準電機工業股份有限公司 SUNONWEALTH ELECTRIC MACHINE INDUSTRY CO., LTD.	SPEC. NO.	132429300	REVISE DATE	
	ISSUE DATE	06. 05. 1996	EDITION	0
	PAGE	6 OF 6		