





**Air moving solutions made simple**

AC Fans  
DC Fans

AC Blowers  
DC Blowers

AC Impellers  
DC Impellers

AC  
Motors

Accessories

**Search**

- Part/Model #
- Stock Check
- Cross-Reference
- Keyword

Find Fans

[Distributors](#)   [Find a Rep](#)   [Contact Us](#)

**Muffin XL - MD48B5 - 028887 - No**  
 (Family)                      (Model)                      (Part #)                      (In Stock)



**Electrical Specifications**

<b>Operating Voltage:</b>	<b>48 Volts</b>
<b>Voltage Range:</b>	<b>24 - 56 Volts</b>
<b>Power Supply:</b>	<b>5.8 Watts</b>
<b>Line Current:</b>	<b>0.12 Amps</b>
<b>Locked Rotor Current:</b>	<b>0.40 Amps</b>
<b>Nominal Speed:</b>	<b>3100 RPM</b>

**Mechanical Specifications**

<b>Dimensions:</b>	<b>4.7 x 4.7 x 1.5 in</b>
<b>Weight:</b>	<b>21.52 oz</b>
<b>Max Airflow @ 0 in H<sub>2</sub>O</b>	<b>110.0 CFM</b>
<b>Max Pressure @ 0 CFM</b>	<b>0.278 in H<sub>2</sub>O</b>
<b>Noise</b>	<b>50.0 dBA</b>



 Detailed Drawing    Printer-Friendly Datasheet

- More Products
- Heat Sinks
- Fan Accessories
- Engineering Tools
- Airflow Calculator
- Thermal Calculator
- Unit Conversions
- Application Notes
- Custom Solutions
- Company Info
- Contact Info
- Technical Capability
- Certifications
- Terms & Conditions
- Employment Ops

**Mechanical Drawing**

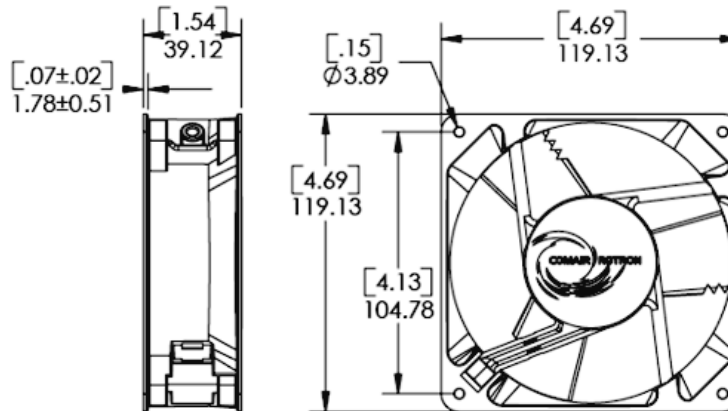

**Fan Performance Curve**

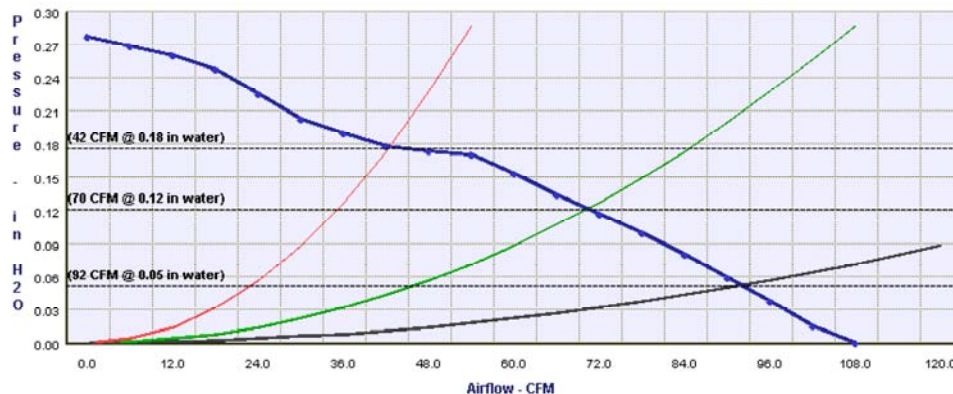

## Fan Configuration Options

- |   |   |  |   |
|---|---|--|---|
| <b>Muffin XL</b><br>(Family)  | <b>MD48B5 / 028887</b><br>(Model)   | <b>No</b><br>(In Stock)  | <b>305 mm [12 inch] Leads</b><br>(Features)                               |
| <b>Fan Speeds</b>   | <b>Fan Bearings</b>   | <b>Fan Airflow Directions</b>  | <b>Fan Terminations</b>   |
| <input type="radio"/> High Speed (3600 RPM)<br><input checked="" type="radio"/> Full Speed (3100 RPM) | <input checked="" type="radio"/> Ball Bearings<br><input type="radio"/> Sleeve Bearings | <input checked="" type="radio"/> Flow L (CW Rotation)<br><input type="radio"/> Flow R (CCW Rotation) | <input checked="" type="radio"/> Leads<br><input type="radio"/> Terminals |

### Fan Monitoring Options

- No Fan Monitoring Options Required  
 Add Tachometer (1 pulses per revolution.)
- Open Collector Output  
 TTL (+5V) Output
- Existing Models with Tachometer Option:
- |  |  |  |  |
|--|--|--|--|
| <input checked="" type="radio"/> MD48B5 / 028887 | <input type="radio"/> MD48B5-E2 / 039011 | <input type="radio"/> MD48B5X / 031250 | <input type="radio"/> MD48B5X / 031469 |
| <input type="radio"/> MD48B5X / 031985           | <input type="radio"/> MD48B5X / 032504   | <input type="radio"/> MD48B9 / 028890  | <input type="radio"/> MD48B9X / 030205 |
| <input type="radio"/> MD48K5 / 032863            | <input type="radio"/> MD48K5X / 039238   |  |  |
- Add Fan Performance Sensor (FPS)



### Fan Speed Control Options

- Add ThermaPro-V Fan Speed Control

### Environmental Protection Options

- Add Enviroschild Environmental Protection

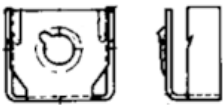
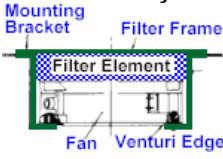
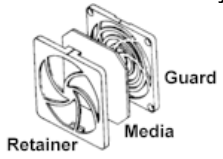
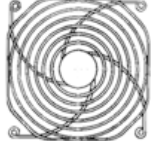
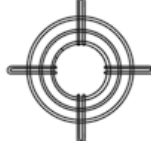
## Accessories (Click on part number for detailed drawing.)

<input type="checkbox"/> <b>571064</b> Plug and Cord 	<input type="checkbox"/> <b>550113</b> Mounting Clip 	<input type="checkbox"/> <b>551590</b> Filter Assembly 	<input type="checkbox"/> <b>554148</b> Filter Guard Assembly 
<input type="checkbox"/> <b>552934</b> Finger Guard 	<input type="checkbox"/> <b>476042</b> Finger Guard 	<input type="checkbox"/> <b>550481</b> Finger Guard 	<input type="checkbox"/> <b>551147</b> Finger Guard 

Comair Rotron, Inc.  
Phone: 619.651.2000  
sales@comairrotron.com

Comair Rotron Europe, Ltd.  
Phone: +44.1527.520525  
saleseurope@comairrotron.com

Comair Rotron Fan Company Ltd.  
Phone: +86.21.52260581  
salesasia@comairrotron.com