

**ebm-papst St. Georgen GmbH & Co. KG**

Hermann-Papst-Straße 1

78112 St. Georgen

Phone: +49 7724 81-0

Fax: +49 7724 81-1309

www.ebmpapst.com

info2@de.ebmpapst.com

Nominal data

Type	6314 /2 TDHHP	
Nominal voltage	[VDC]	24
Nominal voltage range	[VDC]	16 .. 36
Speed	[min ⁻¹]	7000
Power input	[W]	67
Min. ambient temperature	[°C]	-20
Max. ambient temperature	[°C]	70
Air flow	[m ³ /h]	710
Sound power level	[B]	7.9
Sound pressure level	[dB(A)]	69

ml = max. load · me = max. efficiency · rfa = running at free air · cs = customer specs · cu = customer unit
Subject to alterations

Technical features

Dimensions	172 Ø x 51 mm
General description	Very smooth running 3-phase fan drive. Very rigid compression curve for high air flow at high counterpressure. Low operating noise level at high counterpressure. Standard with PWM control input and speed signal. Electronic commutation completely integrated.
Direction of protection	Counterclockwise, looking at rotor
Direction of air flow	Air exhaust over bars
Note	Speed control range from 1000 rpm to maximum nominal speed. Standstill at 0% PWM, maximum speed at sensor break.
Bearing	Ball bearings
Lifetime L10 at 40 °C	62500 h
Lifetime L10 at maximum temperature	30000 h
Mass	0.910 kg
Housing material	Aluminum. Housing with grounding lug for screw M4 x 8 (TORX).
Material of impeller	Fiberglass-reinforced PA plastic
Motor protection	Protected against reverse polarity and locking.

Product drawing

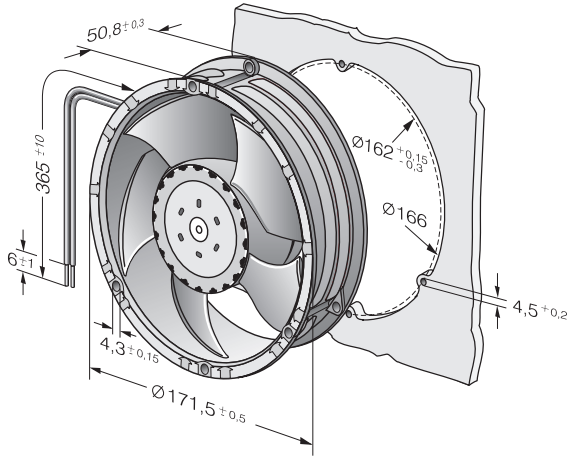

Charts: Air flow

