

RG 125-19/12 N

DC centrifugal compact fan

single inlet



ebm-papst St. Georgen GmbH & Co. KG

Hermann-Papst-Straße 1

78112 St. Georgen

Phone: +49 7724 81-0

Fax: +49 7724 81-1309

www.ebmpapst.com

info2@de.ebmpapst.com

Nominal data

Type	RG 125-19/12 N	
Nominal voltage	[VDC]	12
Nominal voltage range	[VDC]	7 .. 15
Speed	[min ⁻¹]	2550
Power input	[W]	5.0
Min. ambient temperature	[°C]	-30
Max. ambient temperature	[°C]	75
Air flow	[m ³ /h]	87.5
Sound power level	[B]	5.8

ml = max. load · me = max. efficiency · rfa = running at free air · cs = customer specs · cu = customer unit
Subject to alterations

Technical features

Dimensions	180 x 180 x 40 mm
General description	Optional Vario-Pro: Highly flexible software configuration for the fan ensures an easily customizable solution to meet the individual requirements of your application. Backward curved impeller. Electronic commutation completely integrated.
Connection line	Single strands AWG 22, TR 64, bared and tin-plated.
Locked-rotor protection	Blocking and overload protection
Direction of air flow	Axial air intake, centrifugal air exhaust out of the outlet.
Bearing	Ball bearings
Lifetime L10 at 40 °C	62500 h
Lifetime L10 at maximum temperature	27500 h
Mass	0.730 kg
Housing material	Scroll housing of fiberglass-reinforced plastic, housing base of sheet steel.
Material of impeller	Fiberglass-reinforced plastic
Motor protection	Protected against reverse polarity and locking.
Option	Speed signal
Approval	VDE, CSA, UL, CE

Product drawing

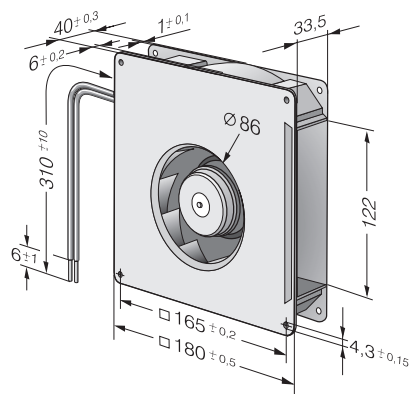

Charts: Air flow

