

**ebm-papst St. Georgen GmbH & Co. KG**

Hermann-Papst-Straße 1

78112 St. Georgen

Phone: +49 7724 81-0

Fax: +49 7724 81-1309

www.ebmpapst.com

info2@de.ebmpapst.com

Nominal data

Type	3312 G	
Nominal voltage	[VDC]	12
Nominal voltage range	[VDC]	6 .. 15
Speed	[min ⁻¹]	3000
Power input	[W]	2.4
Min. ambient temperature	[°C]	-20
Max. ambient temperature	[°C]	75
Air flow	[m ³ /h]	80
Sound power level	[B]	5.2
Sound pressure level	[dB(A)]	37

ml = max. load · me = max. efficiency · rfa = running at free air · cs = customer specs · cu = customer unit
Subject to alterations

Technical features

Dimensions	92 x 92 x 32 mm
General description	Optional Vario-Pro: Highly flexible software configuration for the fan ensures an easily customisable solution to meet the individual requirements of your application. Electronic commutation completely integrated.
Connection line	Single strands AWG 22, TR 64, bared and tin-plated.
Direction of protection	Right, looking at rotor
Direction of air flow	Air exhaust over bars
Bearing	Sintec sleeve bearing
Lifetime L10 at 40 °C	70000 h
Lifetime L10 at maximum temperature	30000 h
Mass	0.190 kg
Housing material	Fiberglass-reinforced PBT plastic
Material of impeller	Fiberglass-reinforced PA plastic
Motor protection	Protected against reverse polarity and locking.
Approval	VDE, CSA, UL

Product drawing

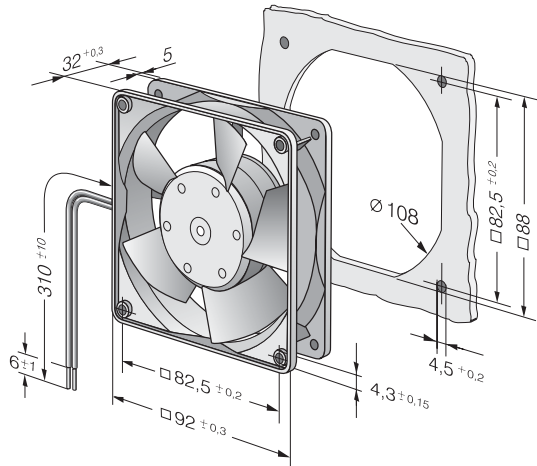

Charts: Air flow

