



SPECIFICATION FOR APPROVAL

Customer _____

Description FAN TRAY

Part No. _____ REV. 01

Delta Model No. FTA0302AA REV. 01

Sample Issue No. _____

Sample Issue Date FEB.16.2009

PLEASE SEND ONE COPY OF THIS SPECIFICATION
BACK AFTER YOU SIGNED APPROVAL FOR
PRODUCTION PRE-ARRANGMENT.

APPROVED BY: _____

DATE : _____

DELTA ELECTRONICS, INC.
TAOYUAN PLANT
252, SHANG YING ROAD, KUEI SAN INDUSTRIAL ZONE
TAOYUAN SHIEN, TAIWAN, R.O.C.
TEL:886-(0)3-3591968
FAX:886-(0)3-3591991

DELTA ELECTRONICS, INC.
 252, SHANG YING ROAD, KUEI SAN
 TAOYUAN HSIEN 333, TAIWAN, R. O. C.

TEL : 886-(0)3-3591968
 FAX : 886-(0)3-3591991

SPECIFICATION FOR APPROVAL

Customer:

Description: FAN TRAY

Customer P/N: REV: 01

Delta FAN Model NO.: FTA0302AA

Sample Rev: 01 Issue NO:

Sample Issue Date: FEB.16.2009 Quantity: SETS

1. SCOPE:

THIS SPECIFICATION DEFINES THE ELECTRICAL AND MECHANICAL CHARACTERISTICS OF THE DC BRUSHLESS AXIAL FLOW HOT SWAP FAN TRAY.

2. CHARACTERS:

ITEM		DESCRIPTION	
RATED VOLTAGE		AC 110V OR 220V	
OPERATION VOLTAGE		AC 100V ~ AC 240V	
INPUT CURRENT		0.1A (MAX.)	0.65 A (MAX.)
INPUT POWER		10 W (MAX.)	65 W (MAX.)
SPEED		1800 $\pm 1\%$ R.P.M.	3800 $\pm 1\%$ R.P.M.
TEMP.(°C)	T off	T min.	T max.
TEMP. SET(°C)	0 ~ (Tmin.-3) STOP	(Toff+3)~(Tmax-1) LOW SPEED	(Tmin+1) ~ 70 HI SPEED
SPEED SET.	0	1800 ~ HI-100	LOW+100 ~ 3800
AIR FLOW (AT ZERO STATIC PRESSURE)		4.3(MIN. 3.87)M ³ /MIN. 155(MIN 139.5)CFM	9.8(MIN. 8.8)M ³ /MIN. 335(MIN 301.5)CFM
MAX.AIR PRESSURE (AT ZERO AIRFLOW)		3.7(MIN. 3.0)mmH ₂ O 0.14(MIN. 0.11)inchH ₂ O	14.2(MIN. 11.5)mmH ₂ O 0.56(MIN. 0.45)inchH ₂ O
ACOUSTICAL NOISE (AVG.)		43 dBA TYP. 47 dBA MAX.	60 dBA TYP. 64 dBA MAX.
INSULATION TYPE		UL: CLASS A	

PART NO:

DELTA FAN MODEL: FTA0302AA

FAN INSULATION STRENGTH	10 MEG OHM MIN. AT 500 VDC (BETWEEN FRAME AND (+) TERMINAL)
FAN DIELECTRIC STRENGTH	5 mA MAX. AT 500 VAC 60 Hz ONE MINUTE, (BETWEEN FRAME AND (+) TERMINAL)
POWER INSULATION RESISTANCE	INPUT TO OUTPUT: 50MOHM AT 500VDC
POWER DIELECTRIC STRENGTH	PRIMARY TO SECONDARY: DC4242V 0.25mA 1 MINUTE FOR TYPE TEST, 1 SECOND FOR PRODUCTION
POWER LEAK CURRENT	INPUT TO OUTPUT: 0.25mA (MAX.) AT 250 VAC/60HZ
FAN EXTERNAL COVER	OPEN TYPE
LIFE EXPECTANCE	70,000 HOURS CONTINUOUS OPERATION AT 40 °C WITH 15 ~ 65 %RH.
FAN ROTATION	CLOCKWISE VIEW FROM NAME PLATE SIDE
FAN OVER CURRENT SHUT DOWN	THE CURRENT WILL SHUT DOWN WHEN LOCKING ROTOR
FANLEAD WIRE	UL 1430 -F- AWG #22 BLACK WIRE NEGATIVE(-) RED WIRE POSITIVE(+) BLUE WIRE (FOO) YELLOW WIRE (PWM)

PART NO:

DELTA FAN MODEL: FTA0302AA

- NOTE A: 1. ALL READINGS ARE MEASURED AFTER STABLY WARMING UP THROUGH 10 MINUTES.
2. THE VALUES WRITTEN IN PARENS , (), ARE LIMITED SPEC.
3. ACOUSTICAL NOISE MEASURING CONDITION:

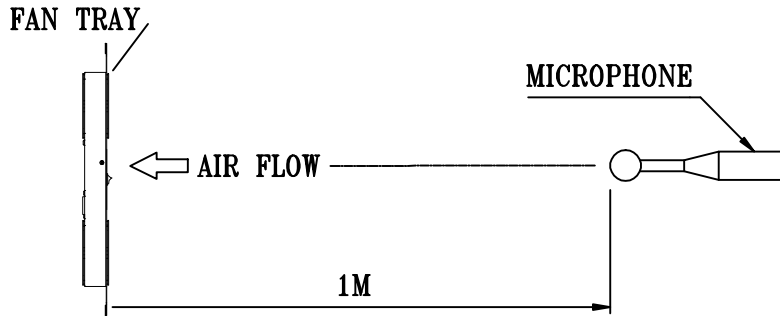

NOISE IS MEASURED AT RATED VOLTAGE IN FREE AIR IN ANECHOIC CHAMBER WITH B & K SOUND LEVEL METER WITH MICROPHONE AT A DISTANCE OF ONE METER FROM THE FAN INTAKE.

NOTE B: FAN SPEED VS. TEMP.

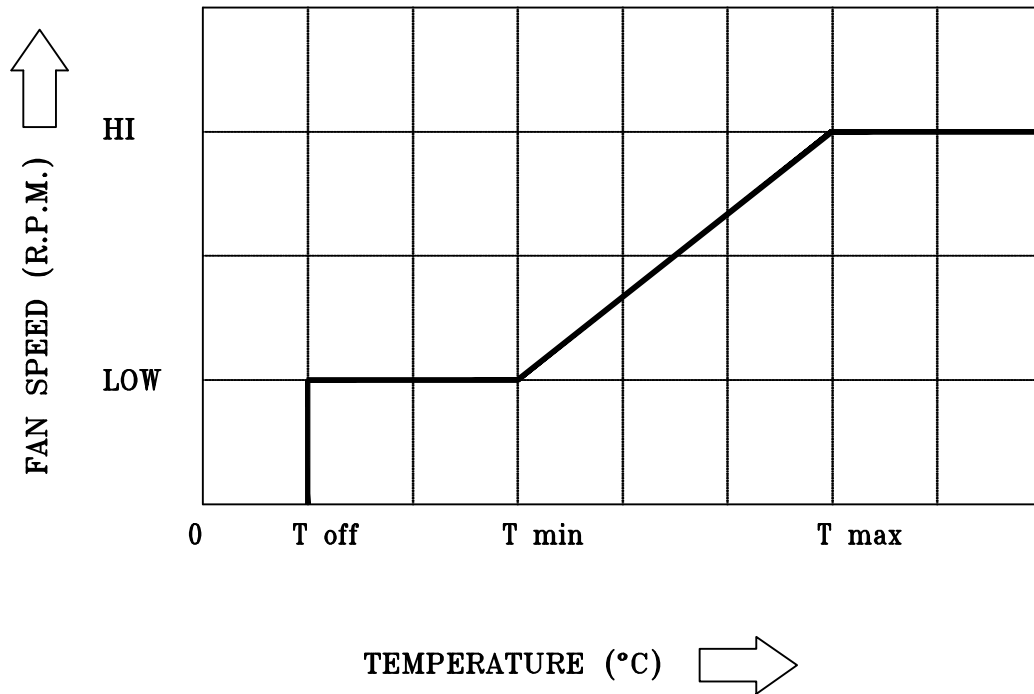

PART NO:

DELTA FAN MODEL: FTA0302AA

3. MECHANICAL:

3-0. DIMENSIONS _____ SEE DIMENSION DRAWINGS

3-1. MATERIALS _____ SEE PART TABLE

3-2. WEIGHT _____ 1.9 KG(REF.)

4. ENVIRONMENTAL:

4-1. OPERATING TEMPERATURE _____ 0 TO +70 DEGREE C

4-2. STORAGE TEMPERATURE _____ -40 TO +75 DEGREE C

4-3. OPERATING HUMIDITY _____ 5 TO 90 % RH

4-4. STORAGE HUMIDITY _____ 5 TO 95 % RH

5. PROTECTION:

5-1. LOCKED ROTOR PROTECTION

IMPEDANCE OF MOTOR WINDING PROTECTS MOTOR FROM FIRE IN 96 HOURS OF LOCKED ROTOR CONDITION AT THE RATED VOLTAGE.

5-2. POLARITY PROTECTION

BE CAPABLE OF WITHSTANDING IF REVERSE CONNECTION FOR POSITIVE AND NEGATIVE LEADS.

6. RE OZONE DEPLETING SUBSTANCES:

6-1. NO CONTAINING PBBs, PBBOs, CFCs, PBBEs, PBDPEs AND HCFCs.

7. PRODUCTION LOCATION

7-1. PRODUCTS WILL BE PRODUCED IN CHINA OR THAILAND OR TAIWAN.

PART NO:

DELTA FAN MODEL: FTA0302AA

8. P & Q CURVE:

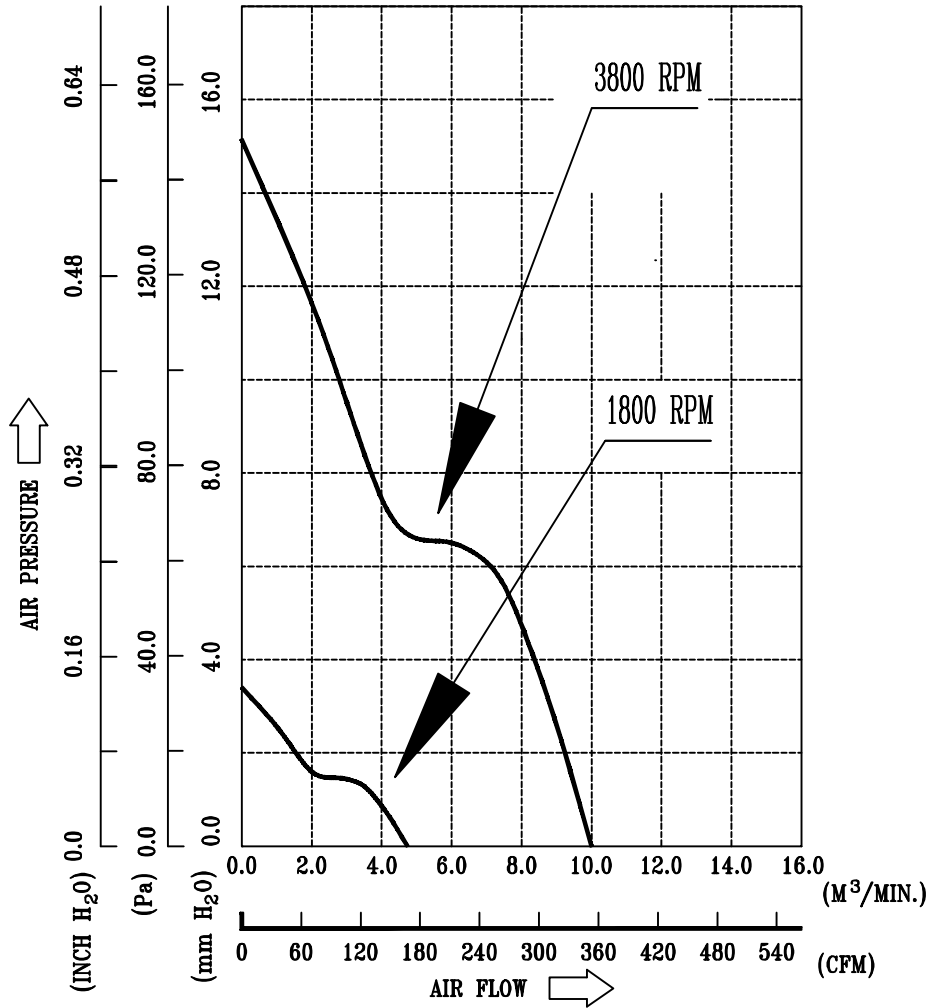

* TEST CONDITION: INPUT VOLTAGE — OPERATION VOLTAGE
TEMPERATURE — ROOM TEMPERATURE
HUMIDITY — 65%RH

PART NO:

DELTA FAN MODEL: FTA0302AA

9-1. SHEETMETAL DIMENSION DRAWINGS:

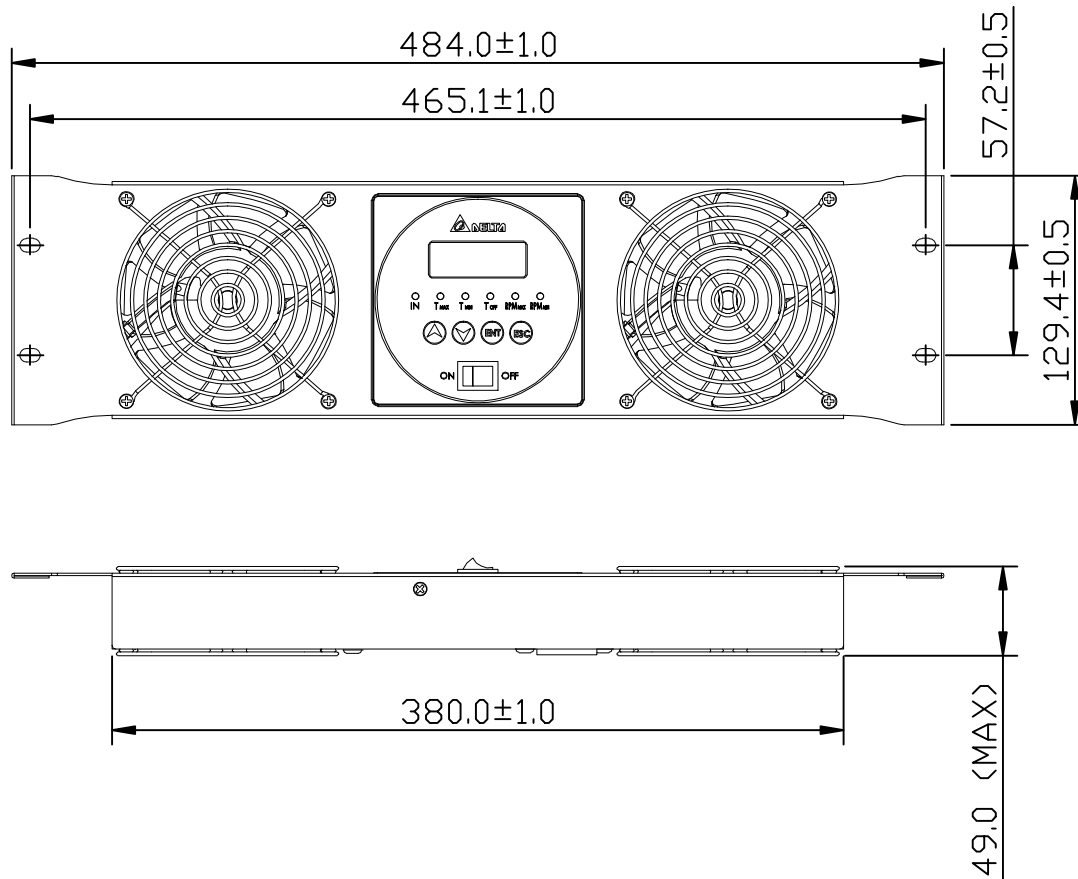

FAN LABEL:

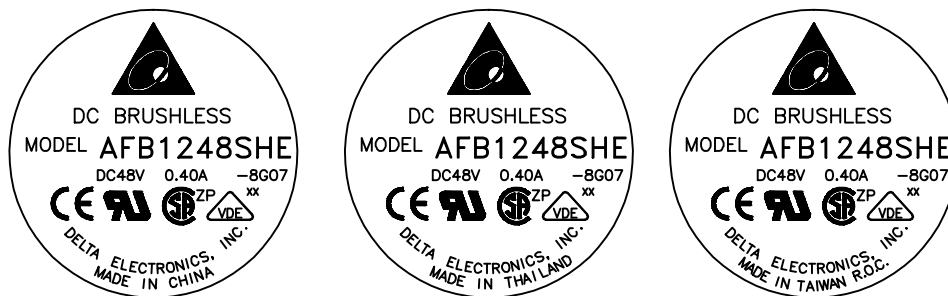

*THIS PRODUCT IS RoHS COMPLIANCE.

PART NO:

DELTA FAN MODEL: FTA0302AA

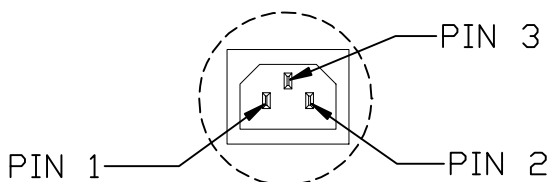
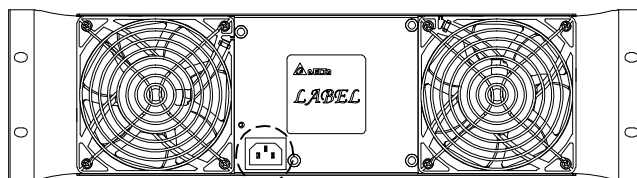
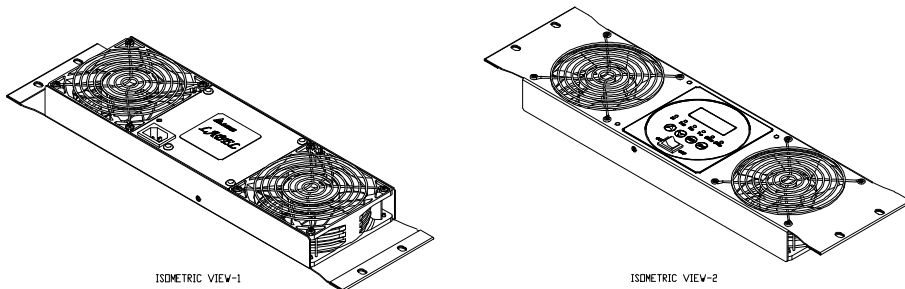

FTA0102AA PIN ASSIGNMENT	
BACKPLANE SOCKET C14 SK-1015	
PIN 1	LINE(L)
PIN 2	NATURE(N)
PIN 3	GROUND(⚡)

FANTRAY LABEL:

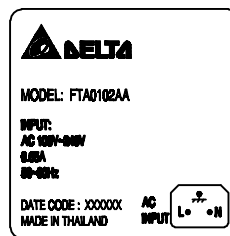
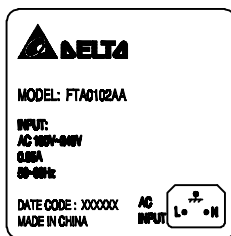
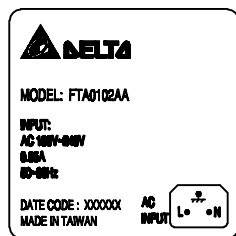

PART NO:

DELTA FAN MODEL: FTA0302AA

10. CONTROLLER OPERATION:

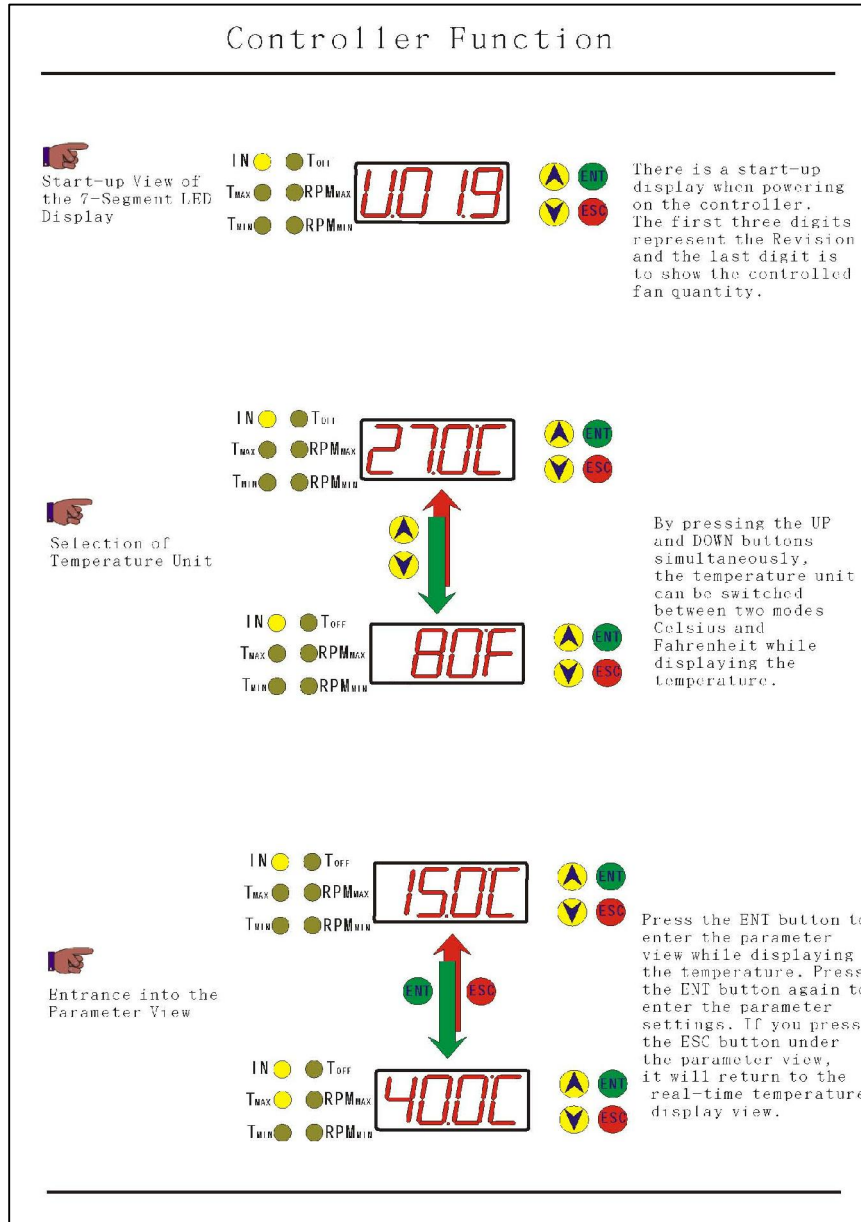

PART NO:

DELTA FAN MODEL: FTA0302AA

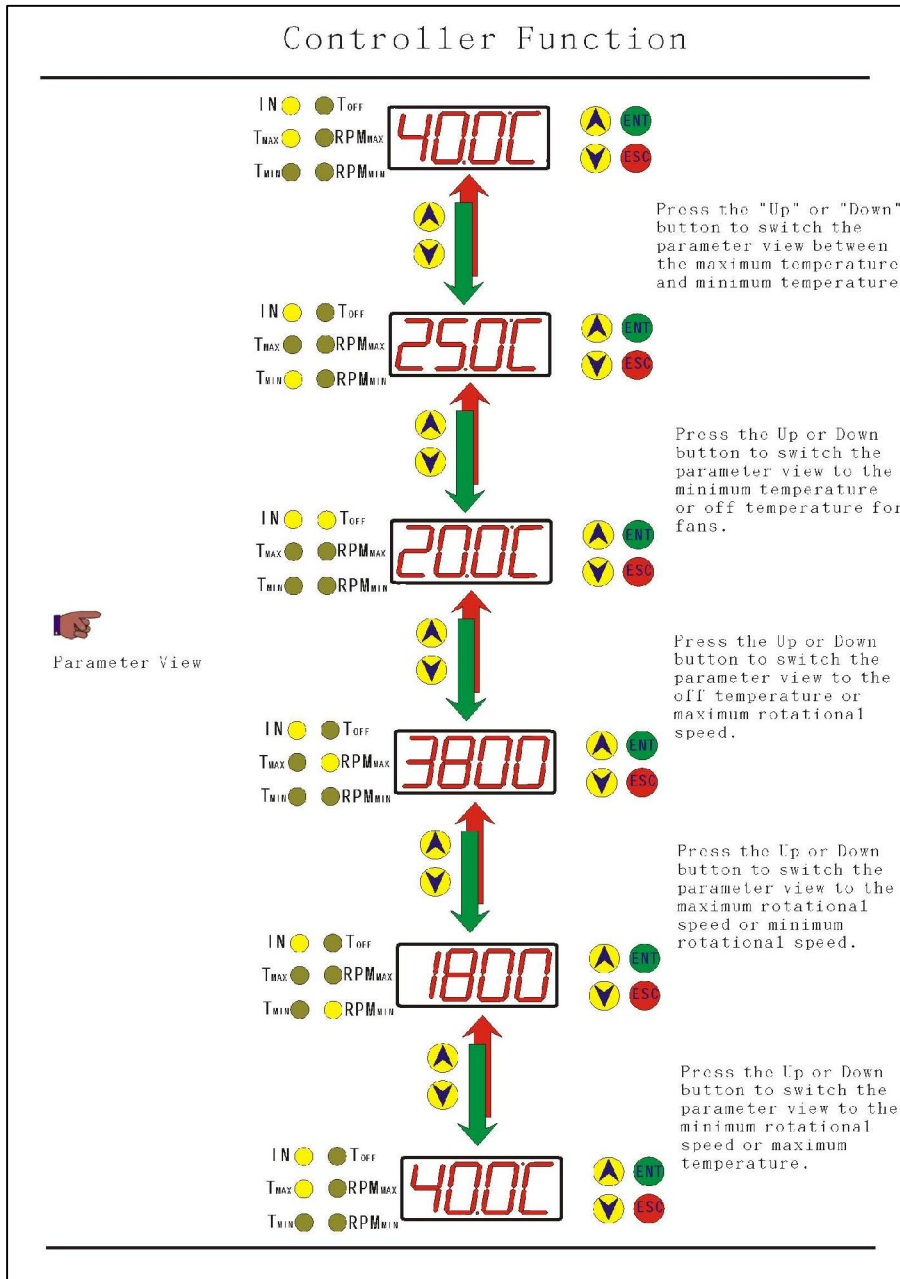

PART NO:

DELTA FAN MODEL: FTA0302AA

Controller Function

The Temperature Settings

IN ● T_{OFF}
T_{MAX} ● RPM_{MAX}
T_{MIN} ● RPM_{MIN}



In the temperature settings, press the Up or Down button for a 0.1 increment with a single click. To keep pressing down the button, the decimal will change to the unit digit after ten increments and then the unit digit will change to the ten's digit after ten increments. After completing the input, press the ENT button to save the settings.

The Rotational Speed Settings

IN ● T_{OFF}
T_{MAX} ● RPM_{MAX}
T_{MIN} ● RPM_{MIN}



In the rotational speed settings, press the Up or Down button for a 1 increment with a single click. To keep pressing down the button, the unit digit will change to the ten's digit after ten increments and then the ten's digit will change to the hundred's digit after ten increments. After completing the input, press the ENT button to save the settings.

Notes: a. There exists a 1-degree minimum difference between the maximum and minimum temperature.
b. There exists a 3 degree minimum difference between the minimum and off temperature is 3 degrees.
c. There exists a 100 R.P.M. minimum difference between the maximum and minimum rotational speed



Descriptions:

- 1. Delta will not guarantee the performance of the products if the application condition falls outside the parameters set forth in the specification.**
- 2. A written request should be submitted to Delta prior to approval if deviation from this specification is required.**
- 3. Please exercise caution when handling fans. Damage may be caused when pressure is applied to the impeller, if the fans are handled by the lead wires, or if the fans are hard-dropped to the production floor.**
- 4. Except as pertains to some special designs, there is no guarantee that the products will be free from any such safety problems or failures as caused by the introduction of powder, droplets of water or encroachment of insect into the hub.**
- 5. The above-mentioned conditions are representative of some unique examples and viewed as the first point of reference prior to all other information.**
- 6. It is very important to establish the correct polarity before connecting the fan to the power source. Positive (+) and Negative (-). Damage may be caused to the fans if connection is with reverse polarity, as there is no foolproof method to protect against such error.**
- 7. Delta fans are not suitable where any corrosive fluids are introduced to their environment.**
- 8. Please ensure all fans are stored according to the storage temperature limits specified. Do not store fans in a high humidity environment. We highly recommend performance testing is conducted before shipping, if the fans have been stored over 6 months.**
- 9. Not all fans are provided with the Lock Rotor Protection feature. If you impair the rotation of the impeller for the fans that do not have this function, the performance of those fans will lead to failure.**
- 10. Please be cautious when mounting the fan. Incorrect mounting of fans may cause excess resonance, vibration and subsequent noise.**
- 11. It is important to consider safety when testing the fans. A suitable fan guard should be fitted to the fan to guard against any potential for personal injury.**
- 12. Except where specifically stated, all tests are carried out at relative (ambient) temperature and humidity conditions of 25°C, 65%. The test value is only for fan performance itself.**
- 13. Be certain to connect an “over 4.7µF” capacitor to the fan externally when the application calls for using multiple fans in parallel, to avoid any unstable power.**