



Muffin XL - MD24B5 - 028886 - No
 (Family) (Model) (Part #) (In Stock)

Electrical Specifications

Operating Voltage:	24 Volts
Voltage Range:	12 - 28 Volts
Power Supply:	6.0 Watts
Line Current:	0.25 Amps
Locked Rotor Current	0.75 Amps
Nominal Speed:	3100 RPM

Mechanical Specifications

Dimensions:	4.7 x 4.7 x 1.5 in
Weight	21.52 oz
Max Airflow @ 0 in H ₂ O	110.0 CFM
Max Pressure @ 0 CFM	0.278 in H ₂ O
Noise	50.0 dBA



Mechanical Drawing

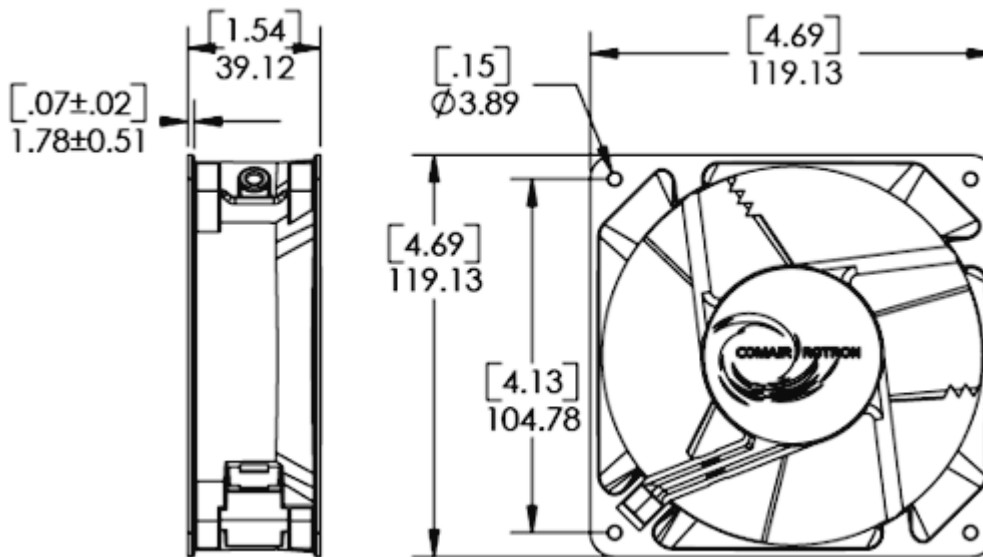

Comair Rotron, Inc.
 Phone: 619.651.2000
 sales@comairrotron.com

Comair Rotron Europe, Ltd.
 Phone: +44.1527.520525
 saleseurope@comairrotron.com

Comair Rotron Fan Company Ltd.
 Phone: +86.21.52260581
 salesasia@comairrotron.com

Print Date: Wednesday, May 12, 2010 at 09:05:10 - DC Fan Datasheet - Web Version 1.0 Rev. B



Fan Performance Curve

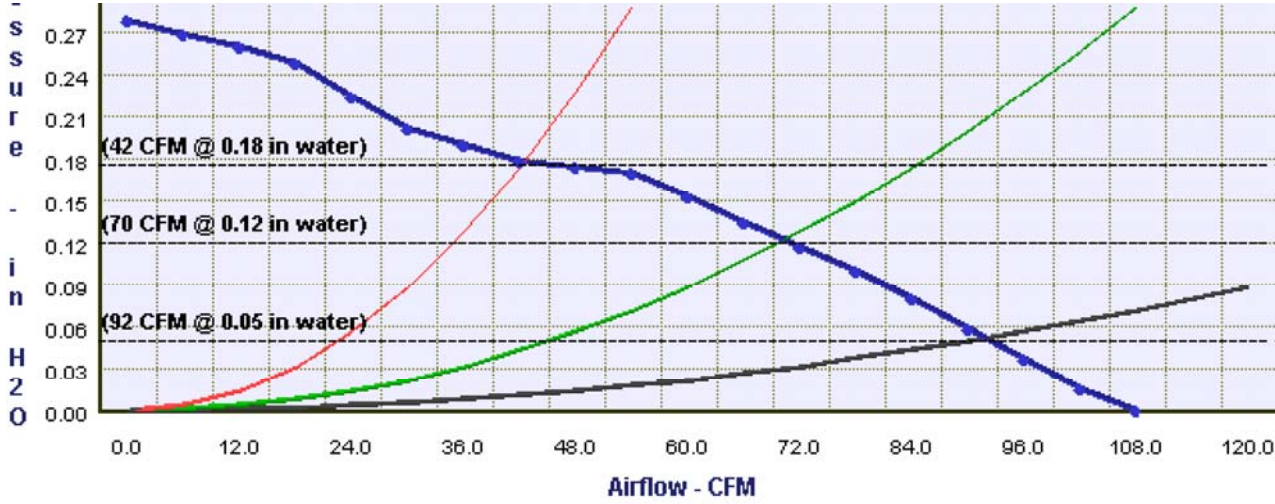

Fan Configuration Options

Muffin XL (Family)
 MD24B5 / 028886 (Model / Part #)
 No (In Stock)
 305 mm [12 inch] Leads (Features)

Fan Speed: 3100 RPM
Fan Bearings: Ball Bearings
Fan Airflow Direction: Flow L (CW Rotation)
Fan Termination: Leads

Fan Monitoring Options: TTL (+5V) Tachometer Output

Fan Speed Control Option: No ThermaPro-V Fan Speed Control Options Selected

Environmental Protection Options: No Enviroshield Options Selected

Comair Rotron, Inc.
 Phone: 619.651.2000
 sales@comairrotron.com

Comair Rotron Europe, Ltd.
 Phone: +44.1527.520525
 saleseurope@comairrotron.com

Comair Rotron Fan Company Ltd.
 Phone: +86.21.52260581
 salesasia@comairrotron.com

Print Date: Wednesday, May 12, 2010 at 09:05:10 - DC Fan Datasheet - Web Version 1.0 Rev. B



Accessories (Click on part number for detailed drawing.)

- 571064
Plug and Cord



- 550113
Mounting Clip

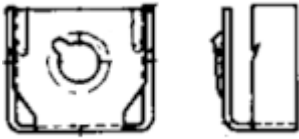

- 551590
Filter Assembly

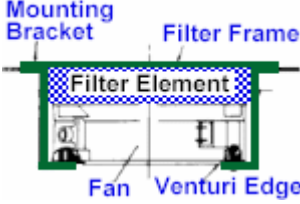

- 554148
Filter Guard Assembly

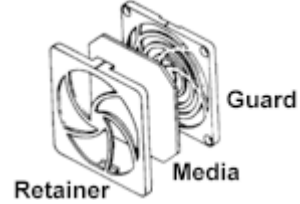

- 552934
Finger Guard

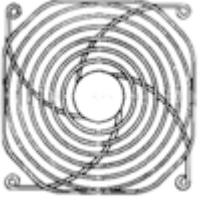

- 476042
Finger Guard

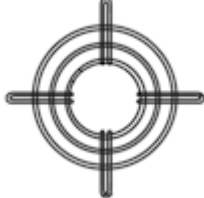

- 550481
Finger Guard

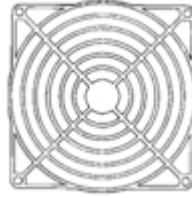

- 551147
Finger Guard

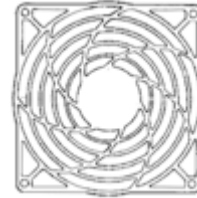

Comair Rotron, Inc.
Phone: 619.651.2000
sales@comairrotron.com

Comair Rotron Europe, Ltd.
Phone: +44.1527.520525
saleseurope@comairrotron.com

Comair Rotron Fan Company Ltd.
Phone: +86.21.52260581
salesasia@comairrotron.com

Print Date: Wednesday, May 12, 2010 at 09:05:10 - DC Fan Datasheet - Web Version 1.0 Rev. B