

**ebm-papst St. Georgen GmbH & Co. KG**

Hermann-Papst-Straße 1

78112 St. Georgen

Phone: +49 7724 81-0

Fax: +49 7724 81-1309

www.ebmpapst.com

info2@de.ebmpapst.com

Nominal data

Type	622 H	
Nominal voltage	[VDC]	12
Nominal voltage range	[VDC]	8 .. 15
Speed	[min ⁻¹]	6850
Power input	[W]	2.3
Min. ambient temperature	[°C]	-20
Max. ambient temperature	[°C]	70
Air flow	[m ³ /h]	46
Sound power level	[B]	5.1
Sound pressure level	[dB(A)]	39

ml = max. load · me = max. efficiency · rfa = running at free air · cs = customer specs · cu = customer unit
Subject to alterations

Technical features

Dimensions	60 x 60 x 25 mm
General description	Rigid compression curve for high air flow at high counterpressure. Motor has very low structure-borne noise. Innovative impeller with winglets for low noise. Electronic commutation completely integrated.
Connection line	Single strands AWG 22, TR 64, bared and tin-plated.
Locked-rotor protection	With electronic blocking and overload protection
Direction of protection	Right, looking at rotor
Direction of air flow	Air exhaust over bars
Bearing	Ball bearings
Lifetime L10 at 40 °C	70000 h
Lifetime L10 at maximum temperature	35000 h
Mass	0.085 kg
Housing material	Fiberglass-reinforced PBT plastic
Material of impeller	Fiberglass-reinforced PA plastic
Motor protection	Protected against reverse polarity and locking.
Option	Control inputs and alarm and speed signal.
Approval	VDE, CSA, UL, CE

Product drawing

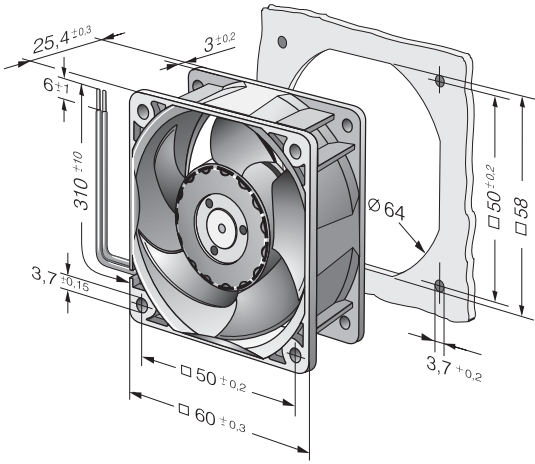

Charts: Air flow

