

Sunon

AC Axial Fan



Fan and Blower

SUNON®

>> AC Axial Fans

02	◇	Engineering Information
03	◇	Model Numbering System
04	◇	80x80x25mm
05	◇	80x80x38mm
06	◇	92x92x25mm
07	◇	120x120x25mm
08	◇	120x120x31mm(Blower) 
09	◇	120x120x38mm
10	◇	120x120x38mm(High Air Flow)
11	◇	120x120x38mm(Plastic Frame)
12	◇	120x120x38mm(Dual AC Voltage-Plastic Frame)
13	◇	120x120x38mm(Dual AC Voltage)
14	◇	120x38mm (Skeleton AC Fan)
15	◇	172x151x51mm
16	◇	∅172x51mm
17	◇	176x176x89mm 
18	◇	∅254x89mm
19	◇	Accessories

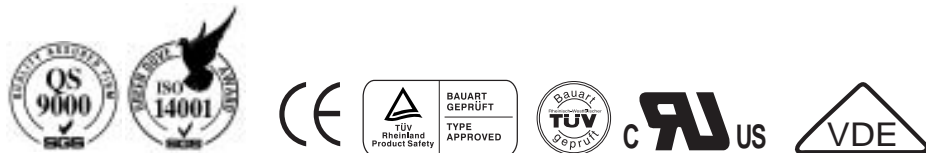

ENGINEERING INFORMATION

Alveolate Motor AC fan series with automatic motor-wire wrapping technology ensures stable performance of high wind volume, low acoustic noise, also available with functions of dual spinning rate, and thermal cutout.



SUNON-Alveolate Motor VS. Traditional Shaded-Pole Motor

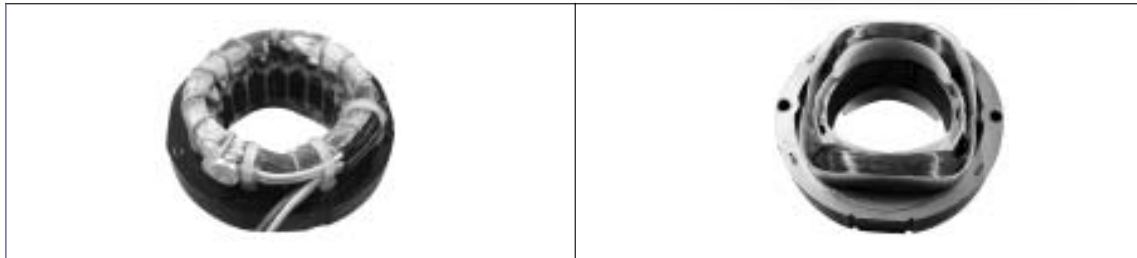

SUNON-Alveolate Motor	Traditional Shaded-Pole Motor
1. The Alveolate Motor is equipped with starting stator coils and working ones. The starting coils form a low starting voltage with the capacitors. For example, an 115VAC (the fixed voltage) Alveolate Motor can be started with 60VAC.	1. The Traditional Shaded-Pole Motor, designed with single-wire wrapping, is started by "the starting copper" and cannot be started with low voltage. An 115VAC Traditional Shaded-Pole motor will need more than 80VAC to run, 20VAC more than the Alveolate one.
2. The coils do not produce high temperature and consumes less electricity. The temperature is normally around 50°C. Therefore, the motor is always stable and reliable.	2. The Traditional Shaded-Pole Motor consumes electricity twice as much as the Alveolate Motor. It is not reliable because the temperature is usually higher than 70°C.
3. The Thermal Cutout can protect the motor.	3. The Thermal Cutout is an option.
4. The motor has a large torsion to produce high wind pressure and wind volume.	4. General wind pressure and wind volume.
5. The motor is equipped with the third wire, ready to comply with the customer's systems.	5. Without the third wire.

MODEL NUMBERING SYSTEM

General AC Fan

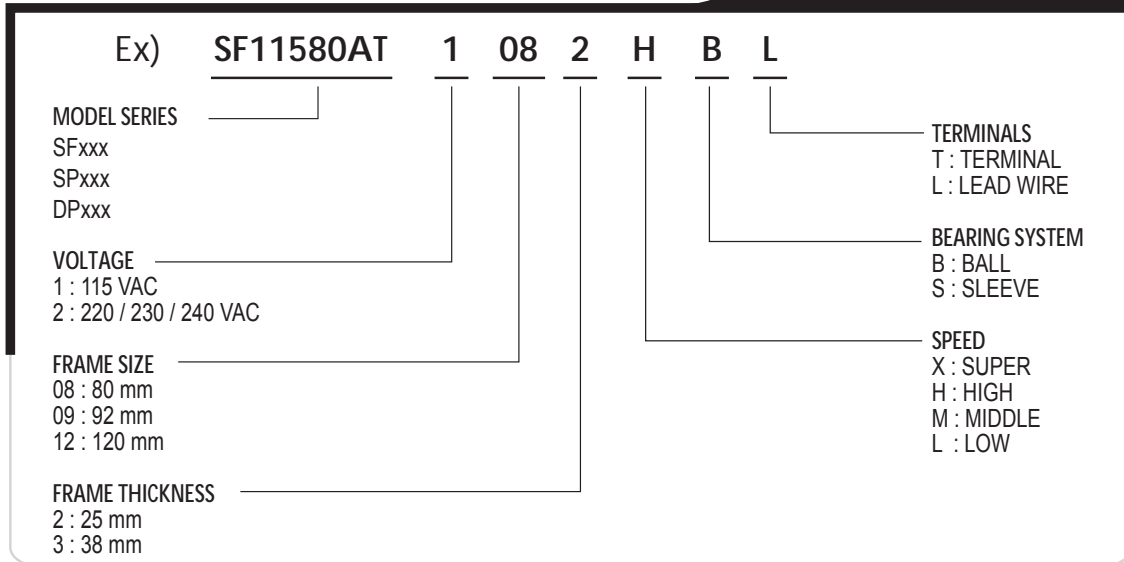

New Type AC Fan

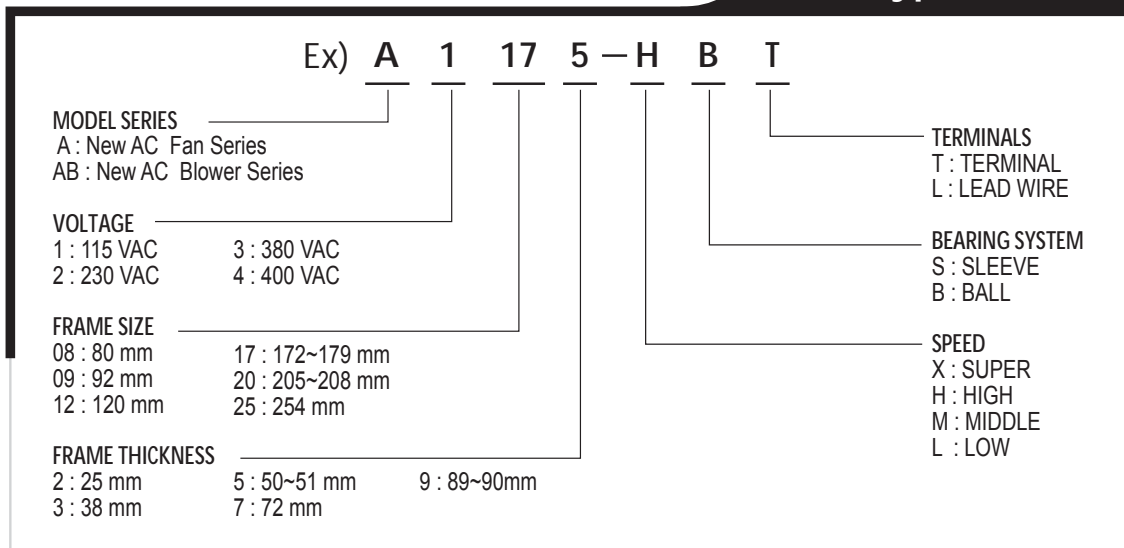

P/N

P/N Suffixes have the following significance :

- T : Thermal Cutout
- C : Capacitor
- TC : Alveolate Motor with Thermal Cutout and Capacitor
- R : Round Frame (Blank : Standard Frame)

* Alveolate Motor only available in P/N : TC model

80x80x25 mm

Bearing Type :Ball / Sleeve bearing

Air Flow:17-22CFM

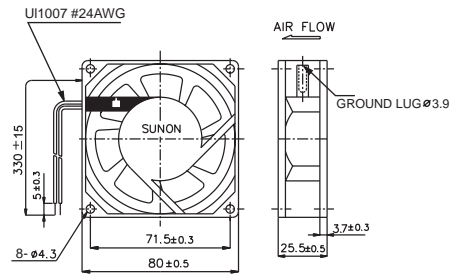
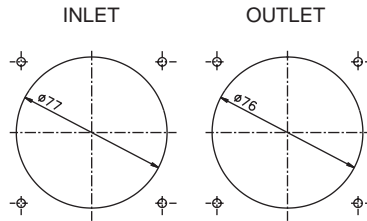

AC Series

Model	P/N	Bearing ⊙ SLEEVE ○ BALL	Rating Voltage (VAC)	Freq. (Hz)	Power Current (AMP)	Power Consumption (WATTS)	Speed (RPM)	Air Flow (CFM)	Static Pressure (Inch-H ₂ O)	Noise (dBA)	Weight (g)
SF11580AT	1082HSL	⊙	115	50/60	0.12/0.10	12/11	2300/2750	17/21	0.12/0.18	29/33	260
SF11580AT	1082HBL	○	115	50/60	0.12/0.10	12/11	2450/2900	18/22	0.13/0.19	30/34.5	260
SF23080AT	2082HSL	⊙	220/240	50/60	0.07/0.07	14/13.5	2300/2750	17/21	0.12/0.18	29/33	260
SF23080AT	2082HBL	○	220/240	50/60	0.07/0.07	14/13.5	2450/2900	18/22	0.13/0.19	30/34.5	260

Frame : Aluminum alloy

Specifications subject to change without notice

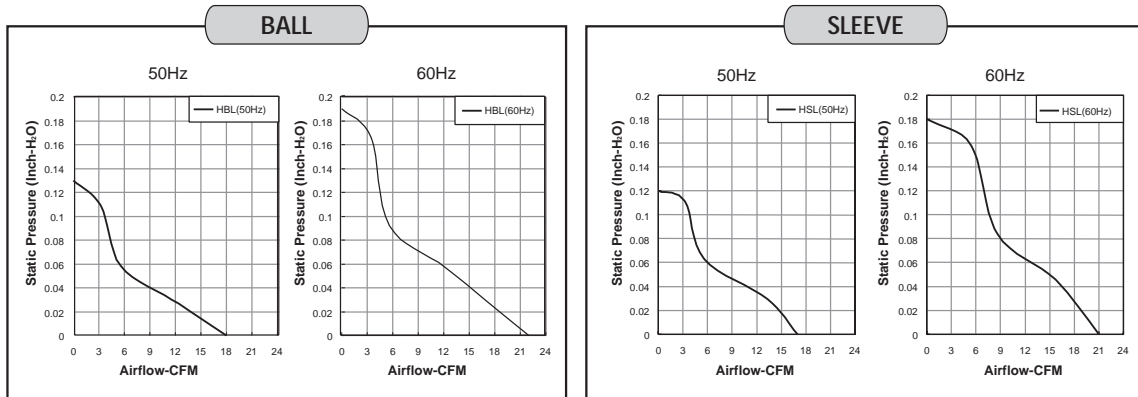

80x80x38 mm

Bearing Type :Ball / Sleeve bearing

Air Flow:23-31CFM

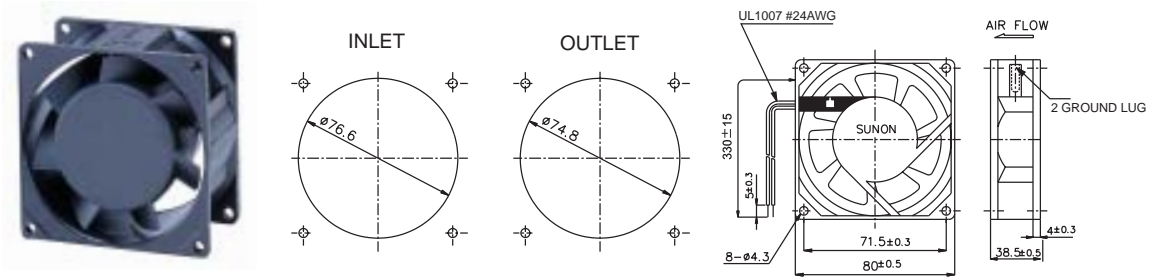

AC Series

Model	P/N	Bearing ⊙ SLEEVE ○ BALL	Rating Voltage (VAC)	Freq. (Hz)	Power Current (AMP)	Power Consumption (WATTS)	Speed (RPM)	Air Flow (CFM)	Static Pressure (Inch-H ₂ O)	Noise (dBA)	Weight (g)
SF11580A	1083HSL	⊙	115	50/60	0.15/0.13	14/12	2300/2750	23/30	0.12/0.18	31/35	340
SF11580A	1083HBL	○	115	50/60	0.15/0.13	14/12	2400/2850	24/31	0.13/0.19	32/36.5	340
SF23080A	2083HSL	⊙	220/240	50/60	0.07/0.06	14/13.5	2300/2750	23/30	0.12/0.18	31/35	340
SF23080A	2083HBL	○	220/240	50/60	0.07/0.06	14/13.5	2400/2850	24/31	0.13/0.19	32/36.5	340

Frame : Aluminum alloy

Specifications subject to change without notice

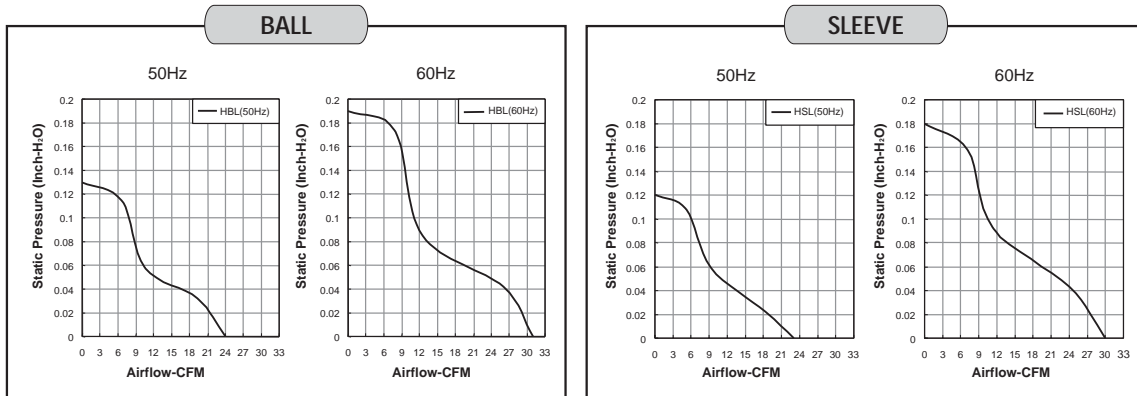

92x92x25 mm

Bearing Type :Ball / Sleeve bearing

Air Flow:21-37CFM

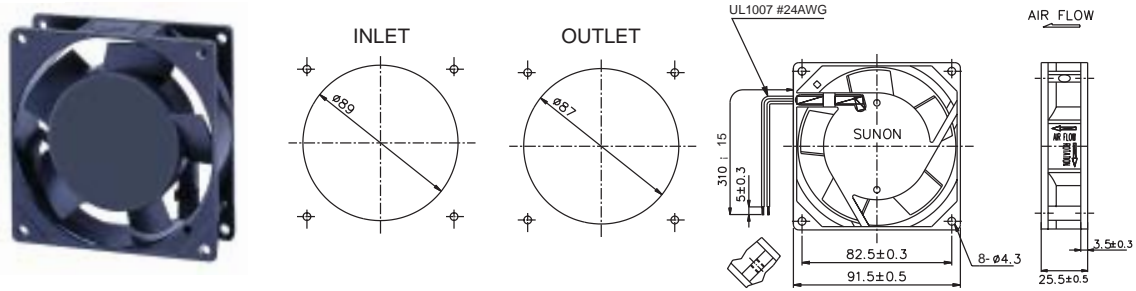

AC Series

Model	P/N	Bearing ⊙ SLEEVE ○ BALL	Rating Voltage (VAC)	Freq. (Hz)	Power Current (AMP)	Power Consumption (WATTS)	Speed (RPM)	Air Flow (CFM)	Static Pressure (Inch-H ₂ O)	Noise (dBA)	Weight (g)
SF11592A	1092HSL	⊙	115	50/60	0.12/0.11	13.0/12	2250/2750	29/36	0.12/0.18	36/39	280
SF11592A	1092HST	⊙	115	50/60	0.12/0.11	13.0/12	2250/2750	29/36	0.12/0.18	36/39	280
SF11592A	1092MSL	⊙	115	50/60	0.06/0.06	7.0/6.0	1550/1700	21/26	0.08/0.09	28/30	280
SF11592A	1092MST	⊙	115	50/60	0.06/0.06	7.0/6.0	1550/1700	21/26	0.08/0.09	28/30	280
SF11592A	1092HBL	○	115	50/60	0.12/0.11	13.0/12	2350/2850	30/37	0.13/0.19	37/40	280
SF11592A	1092HBT	○	115	50/60	0.12/0.11	13.0/12	2350/2850	30/37	0.13/0.19	37/40	280
SF11592A	1092MBL	○	115	50/60	0.07/0.06	7.0/6.0	1800/2100	23/28	0.10/0.11	31/33	280
SF11592A	1092MBT	○	115	50/60	0.07/0.06	7.0/6.0	1800/2100	23/28	0.10/0.11	31/33	280
SF23092A	2092HSL	⊙	220/240	50/60	0.07/0.06	14.5/14	2250/2750	29/36	0.12/0.18	36/39	280
SF23092A	2092HST	⊙	220/240	50/60	0.07/0.06	14.5/14	2250/2750	29/36	0.12/0.18	36/39	280
SF23092A	2092MSL	⊙	220/240	50/60	0.07/0.07	15.0/14	2000/2500	27/33	0.11/0.16	32/37	280
SF23092A	2092MST	⊙	220/240	50/60	0.07/0.07	15.0/14	2000/2500	27/33	0.11/0.16	32/37	280
SF23092A	2092HBL	○	220/240	50/60	0.07/0.06	14.5/14	2350/2850	30/37	0.13/0.19	37/40	280
SF23092A	2092HBT	○	220/240	50/60	0.07/0.06	14.5/14	2350/2850	30/37	0.13/0.19	37/40	280
SF23092A	2092MBL	○	220/240	50/60	0.07/0.07	15.0/14	2200/2700	28/35	0.12/0.18	35/38	280
SF23092A	2092MBT	○	220/240	50/60	0.07/0.07	15.0/14	2200/2700	28/35	0.12/0.18	35/38	280

Frame : Aluminum alloy

Specifications subject to change without notice

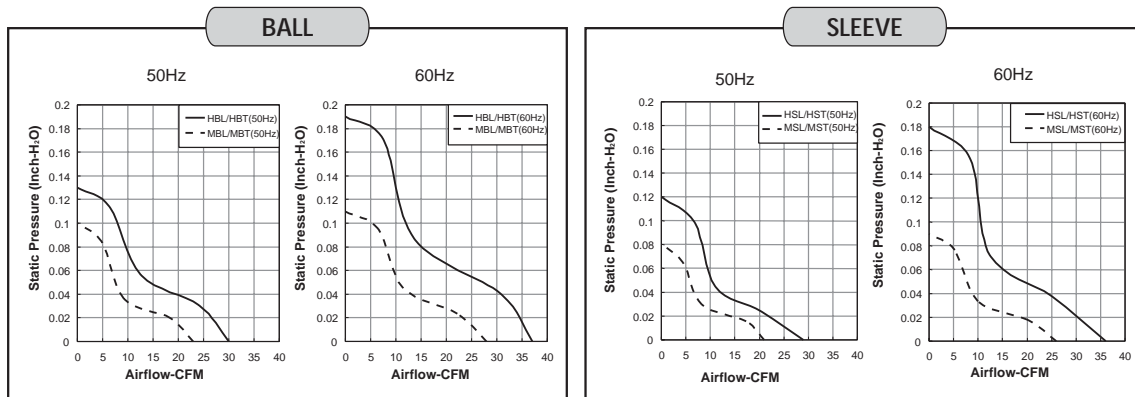

120x120x25 mm

Bearing Type :Ball / Sleeve bearing

Air Flow:46-78CFM

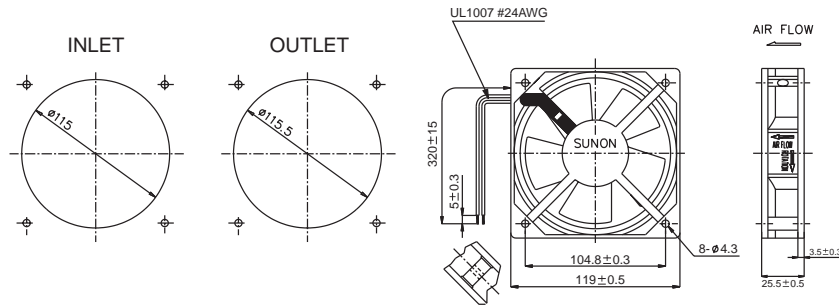

AC Series

Model	P/N	Bearing ⊙ SLEEVE ○ BALL	Rating Voltage (VAC)	Freq. (Hz)	Power Current (AMP)	Power Consumption (WATTS)	Speed (RPM)	Air Flow (CFM)	Static Pressure (Inch-H ₂ O)	Noise (dBA)	Weight (g)
SP101AT	1122HSL	⊙	115	50/60	0.19/0.18	19/18	2000/2200	64/77	0.13/0.15	43/45	330
SP101AT	1122HST	⊙	115	50/60	0.19/0.18	19/18	2000/2200	64/77	0.13/0.15	43/45	330
SP102AT	1122MSL	⊙	115	50/60	0.13/0.12	14/13	1900/2000	54/64	0.13/0.13	42/43	330
SP102AT	1122MST	⊙	115	50/60	0.13/0.12	14/13	1900/2000	54/64	0.13/0.13	42/43	330
SP103AT	1122LSL	⊙	115	50/60	0.14/0.13	14/13	1600/1800	46/53	0.11/0.12	35/38	330
SP103AT	1122LST	⊙	115	50/60	0.14/0.13	14/13	1600/1800	46/53	0.11/0.12	35/38	330
SP101AT	1122HBL	○	115	50/60	0.19/0.18	19/18	2150/2300	66/78	0.14/0.16	44/46	330
SP101AT	1122HBT	○	115	50/60	0.19/0.18	19/18	2150/2300	66/78	0.14/0.16	44/46	330
SP102AT	1122MBL	○	115	50/60	0.13/0.12	14/13	1900/2100	54/64	0.13/0.14	40/44	330
SP102AT	1122MBT	○	115	50/60	0.13/0.12	14/13	1900/2100	54/65	0.13/0.14	40/44	330
SP103AT	1122LBL	○	115	50/60	0.14/0.13	14/13	1700/1900	47/54	0.12/0.13	37/40	330
SP103AT	1122LBT	○	115	50/60	0.14/0.13	14/13	1700/1900	47/54	0.12/0.13	37/40	330
DP201AT	2122HSL	⊙	220/240	50/60	0.09/0.09	19/18	2000/2200	64/77	0.13/0.15	43/45	330
DP201AT	2122HST	⊙	220/240	50/60	0.09/0.09	19/18	2000/2200	64/77	0.13/0.15	43/45	330
DP202AT	2122MSL	⊙	220/240	50/60	0.07/0.07	15/14	1900/2100	54/65	0.13/0.14	42/44	330
DP202AT	2122MST	⊙	220/240	50/60	0.07/0.07	15/14	1900/2100	54/65	0.13/0.14	42/44	330
DP203AT	2122LSL	⊙	220/240	50/60	0.07/0.07	14/13	1600/1800	46/53	0.11/0.12	35/38	330
DP203AT	2122LST	⊙	220/240	50/60	0.07/0.07	14/13	1600/1800	46/53	0.11/0.12	35/38	330
DP201AT	2122HBL	○	220/240	50/60	0.09/0.09	19/18	2150/2300	66/78	0.14/0.16	44/46	330
DP201AT	2122HBT	○	220/240	50/60	0.09/0.09	19/18	2150/2300	66/78	0.14/0.16	44/46	330
DP202AT	2122MBL	○	220/240	50/60	0.07/0.07	15/14	1900/2200	54/77	0.13/0.15	40/45	330
DP202AT	2122MBT	○	220/240	50/60	0.07/0.07	15/14	1900/2200	54/77	0.13/0.15	40/45	330
DP203AT	2122LBL	○	220/240	50/60	0.07/0.07	14/13	1700/1900	47/54	0.12/0.13	37/40	330
DP203AT	2122LBT	○	220/240	50/60	0.07/0.07	14/13	1700/1900	47/54	0.12/0.13	37/40	330

Frame : Aluminum alloy

Specifications subject to change without notice

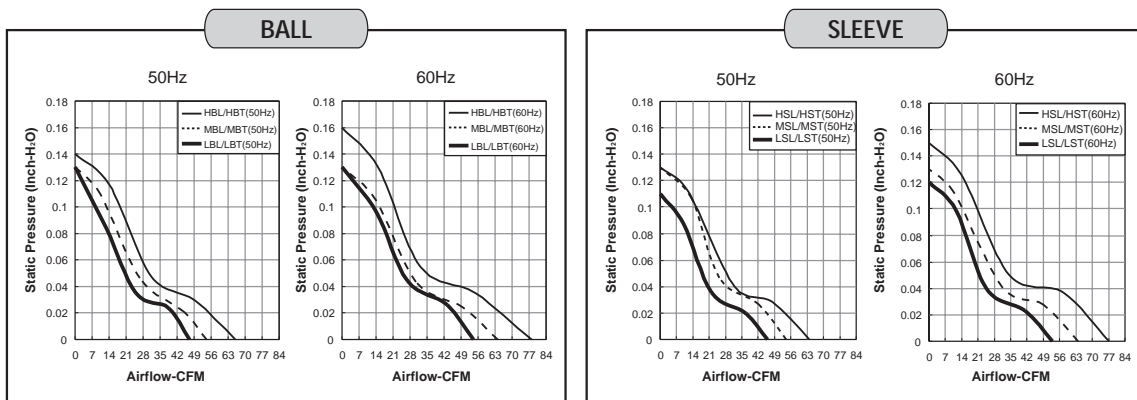

120x120x31 mm (Blower)

Bearing Type : Sleeve bearing
Air Flow:20-22 CFM



AC Series

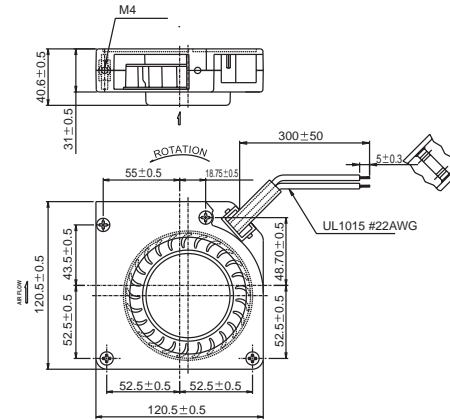

Model	P/N	Bearing ⊙ SLEEVE ○ BALL	Rating Voltage (VAC)	Freq. (Hz)	Power Current (AMP)	Power Consumption (WATTS)	Speed (RPM)	Air Flow (CFM)	Static Pressure (Inch-H ₂ O)	Noise (dBA)	Weight (g)
AB1123-HST		⊙	115	50/60	0.25/0.21	19/17	2600/2850	20/22	0.34/0.5	48/50	657
AB1123-HSL		○	115	50/60	0.25/0.21	19/17	2600/2850	20/22	0.34/0.5	48/50	657

Frame : Aluminum alloy

Specifications subject to change without notice

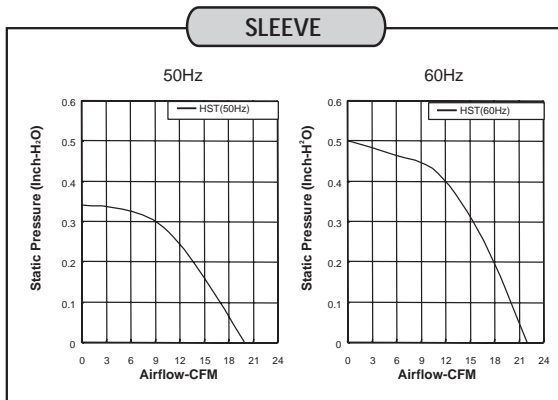

120x120x38 mm

Bearing Type : Ball / Sleeve bearing
Air Flow: 70-117CFM

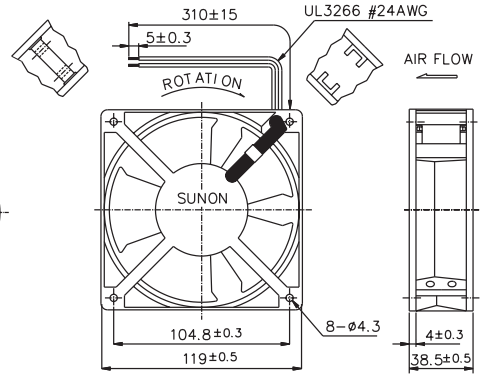
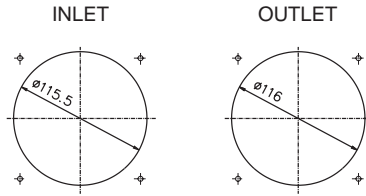

AC Series

Model	P/N	Bearing ⊙ SLEEVE ○ BALL	Rating Voltage (VAC)	Freq. (Hz)	Power Current (AMP)	Power Consumption (WATTS)	Speed (RPM)	Air Flow (CFM)	Static Pressure (Inch-H ₂ O)	Noise (dBA)	Weight (g)
SP100A	1123XSL	⊙	115	50/60	0.26/0.24	22/20	2700/3100	95/115	0.33/0.38	44/49	550
SP100A	1123XST	⊙	115	50/60	0.26/0.24	22/20	2700/3100	95/115	0.33/0.38	44/49	550
SP101A	1123HSL	⊙	115	50/60	0.21/0.18	20/18	2550/2900	85/105	0.25/0.30	43/48	550
SP101A	1123HST	⊙	115	50/60	0.21/0.18	20/18	2550/2900	85/105	0.25/0.30	43/48	550
SP102A	1123MSL	⊙	115	50/60	0.17/0.16	15/15	2400/2600	78/84	0.14/0.21	33/38	543
SP102A	1123MST	⊙	115	50/60	0.17/0.16	15/15	2400/2600	78/84	0.14/0.21	33/38	543
SP103A	1123LSL	⊙	115	50/60	0.13/0.11	11/11	2000/2200	70/76	0.08/0.12	36/38	550
SP103A	1123LST	⊙	115	50/60	0.13/0.11	11/11	2000/2200	70/76	0.08/0.12	36/38	550
SP100A	1123XBL	○	115	50/60	0.26/0.24	22/20	2850/3150	97/117	0.34/0.39	45/50	550
SP100A	1123XBT	○	115	50/60	0.26/0.24	22/20	2850/3150	97/117	0.34/0.39	45/50	550
SP101A	1123HBL	○	115	50/60	0.21/0.18	20/18	2750/3050	87/107	0.26/0.32	45/50	550
SP101A	1123HBT	○	115	50/60	0.21/0.18	20/18	2750/3050	87/107	0.26/0.32	45/50	550
SP102A	1123MBL	○	115	50/60	0.17/0.16	16/15	2500/2700	80/88	0.15/0.22	35/40	550
SP102A	1123MBT	○	115	50/60	0.17/0.16	16/15	2500/2700	80/88	0.15/0.22	35/40	550
SP103A	1123LBL	○	115	50/60	0.13/0.11	11/11	2150/2300	72/78	0.09/0.13	37/39	550
SP103A	1123LBT	○	115	50/60	0.13/0.11	11/11	2150/2300	72/78	0.09/0.13	37/39	550
DP200A	2123XSL	⊙	220/240	50/60	0.14/0.12	22/21	2700/3100	95/115	0.33/0.38	44/49	543
DP200A	2123XST	⊙	220/240	50/60	0.14/0.12	22/21	2700/3100	95/115	0.33/0.38	44/49	543
DP201A	2123HSL	⊙	220/240	50/60	0.125/0.11	20/19	2550/2900	85/105	0.25/0.30	43/48	550
DP201A	2123HST	⊙	220/240	50/60	0.125/0.11	20/19	2550/2900	85/105	0.25/0.30	43/48	550
DP202A	2123MSL	⊙	220/240	50/60	0.09/0.08	16/15	2300/2500	78/84	0.14/0.21	33/38	543
DP202A	2123MST	⊙	220/240	50/60	0.09/0.08	16/15	2300/2500	78/84	0.14/0.21	33/38	543
DP203A	2123LSL	⊙	220/240	50/60	0.06/0.05	11/10	2000/1800	70/63	0.08/0.07	36/32	550
DP203A	2123LST	⊙	220/240	50/60	0.06/0.05	11/10	2000/1800	70/63	0.08/0.07	36/32	550
DP200A	2123XBL	○	220/240	50/60	0.14/0.12	22/21	2850/3150	97/117	0.34/0.39	45/50	550
DP200A	2123XBT	○	220/240	50/60	0.14/0.12	22/21	2850/3150	97/117	0.34/0.39	45/50	550
DP201A	2123HBL	○	220/240	50/60	0.125/0.11	20/19	2750/3050	87/107	0.26/0.32	45/50	550
DP201A	2123HBT	○	220/240	50/60	0.125/0.11	20/19	2750/3050	87/107	0.26/0.32	45/50	550
DP202A	2123MBL	○	220/240	50/60	0.09/0.08	16/15	2400/2600	78/84	0.14/0.21	34/39	543
DP202A	2123MBT	○	220/240	50/60	0.09/0.08	16/15	2400/2600	78/84	0.14/0.21	34/39	543
DP203A	2123LBL	○	220/240	50/60	0.08/0.06	10/10	2150/2300	72/78	0.09/0.13	37/39	550
DP203A	2123LBT	○	220/240	50/60	0.08/0.06	10/10	2150/2300	72/78	0.09/0.13	37/39	550

Frame : Aluminum alloy

Specifications subject to change without notice

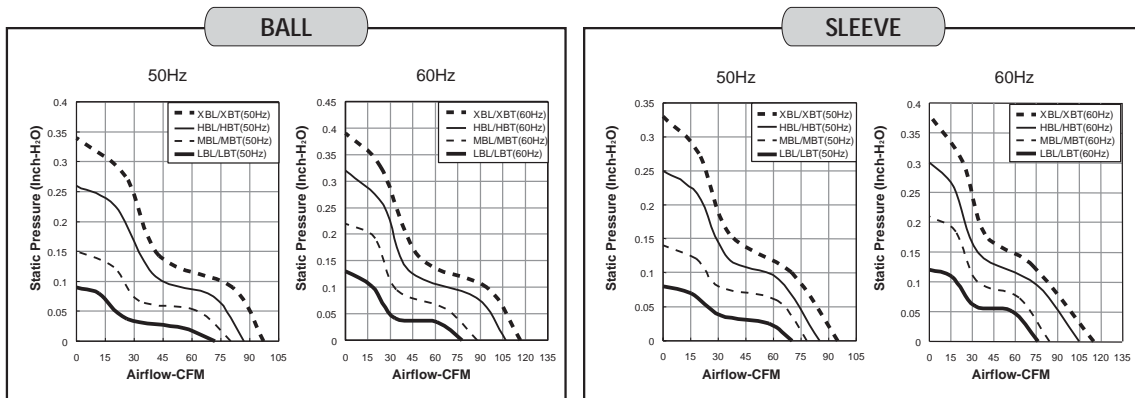

120x120x38 mm (High Air Flow)

Bearing Type :Ball / Sleeve bearing

Air Flow:112-124CFM

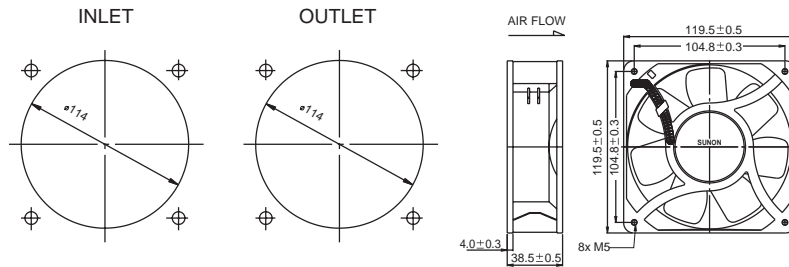

AC Series

Model	P/N	Bearing ⊙ SLEEVE ○ BALL	Rating Voltage (VAC)	Freq. (Hz)	Power Current (AMP)	Power Consumption (WATTS)	Speed (RPM)	Air Flow (CFM)	Static Pressure (Inch-HzO)	Noise (dBA)	Weight (g)
A1123-HSL		⊙	115	50/60	0.28/0.25	23/21	2500/2750	112/124	0.31/0.33	43/46	536
A1123-HST		⊙	115	50/60	0.28/0.25	23/21	2500/2750	112/124	0.31/0.33	43/46	536
A1123-HBL		○	115	50/60	0.28/0.25	23/21	2500/2750	112/124	0.31/0.33	44/47	536
A1123-HBT		○	115	50/60	0.28/0.25	23/21	2500/2750	112/124	0.31/0.33	44/47	536
A2123-HSL		⊙	230	50/60	0.14/0.12	24/22	2500/2750	112/124	0.28/0.31	43/46	536
A2123-HST		⊙	230	50/60	0.14/0.12	24/22	2500/2750	112/124	0.28/0.31	43/46	536
A2123-HBL		○	230	50/60	0.14/0.12	24/22	2500/2750	112/124	0.28/0.31	44/47	536
A2123-HBT		○	230	50/60	0.14/0.12	24/22	2500/2750	112/124	0.28/0.31	44/47	536

Frame : Aluminum alloy

Specifications subject to change without notice

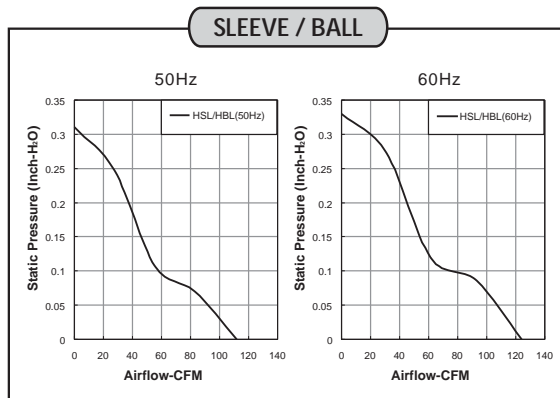

120x120x38 mm

Bearing Type :Ball / Sleeve bearing
Air Flow:75-102 CFM

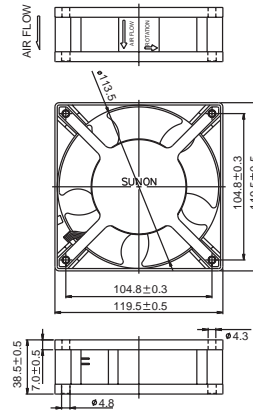
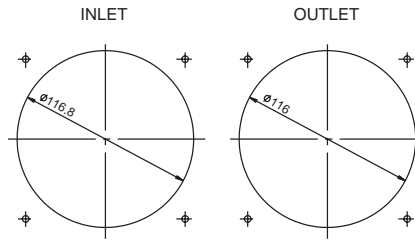

AC Series

Model	P/N	Bearing ⊙ SLEEVE ○ BALL	Rating Voltage (VAC)	Freq. (Hz)	Power Current (AMP)	Power Consumption (WATTS)	Speed (RPM)	Air Flow (CFM)	Static Pressure (Inch-H ₂ O)	Noise (dBA)	Weight (g)
SP109WR	1123HST	⊙	115	50/60	0.23/0.21	20/19	2500/2900	75/100	0.28/0.35	42/47	450
SP109WR	1123HSL	⊙	115	50/60	0.23/0.21	20/19	2500/2900	75/100	0.28/0.35	42/47	450
SP109WR	1123HBT	○	115	50/60	0.23/0.21	20/19	2650/3050	77/102	0.29/0.36	43/48	450
SP109WR	1123HBL	○	115	50/60	0.23/0.21	20/19	2650/3050	77/102	0.29/0.36	43/48	450
DP209WR	2123HST	⊙	220/240	50/60	0.12/0.11	21/21	2500/2900	75/100	0.28/0.35	42/47	450
DP209WR	2123HSL	⊙	220/240	50/60	0.12/0.11	21/21	2500/2900	75/100	0.28/0.35	42/47	450
DP209WR	2123HBT	○	220/240	50/60	0.12/0.11	21/21	2650/3050	77/102	0.29/0.36	43/48	450
DP209WR	2123HBL	○	220/240	50/60	0.12/0.11	21/21	2650/3050	77/102	0.29/0.36	43/48	450

Frame : PBT plastic

Specifications subject to change without notice

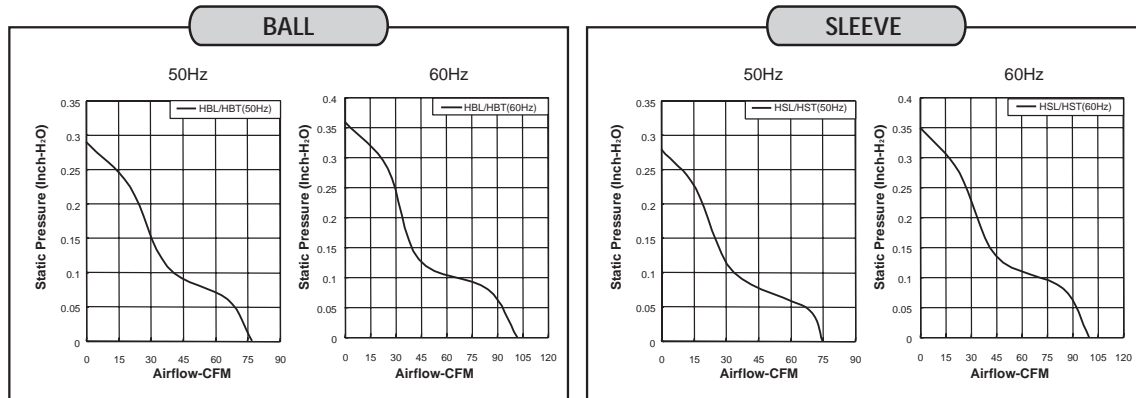

120x120x38 mm (Dual AC voltage)

Bearing Type : Sleeve bearing
Air Flow:85-100 CFM

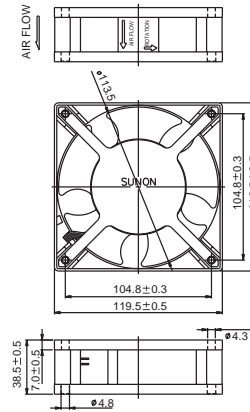
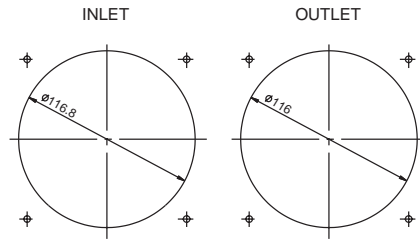

AC Series

Model	P/N	Bearing ⊙ SLEEVE ○ BALL	Rating Voltage (VAC)	Freq. (Hz)	Power Current (AMP)	Power Consumption (WATTS)	Speed (RPM)	Air Flow (CFM)	Static Pressure (Inch-H ₂ O)	Noise (dBA)	Weight (g)
SF309WR	ST	⊙	115	50/60	0.28/0.25	24/22	2500/2900	85/100	0.25/0.30	41/47	470
			230	50/60	0.13/0.12	23/22	2500/2900	85/100	0.25/0.30	41/47	470
SF309WR	SL	⊙	115	50/60	0.28/0.25	24/22	2500/2900	85/100	0.25/0.30	41/47	470
			230	50/60	0.13/0.12	23/22	2500/2900	85/100	0.25/0.30	41/47	470

Frame : PBT plastic

Specifications subject to change without notice

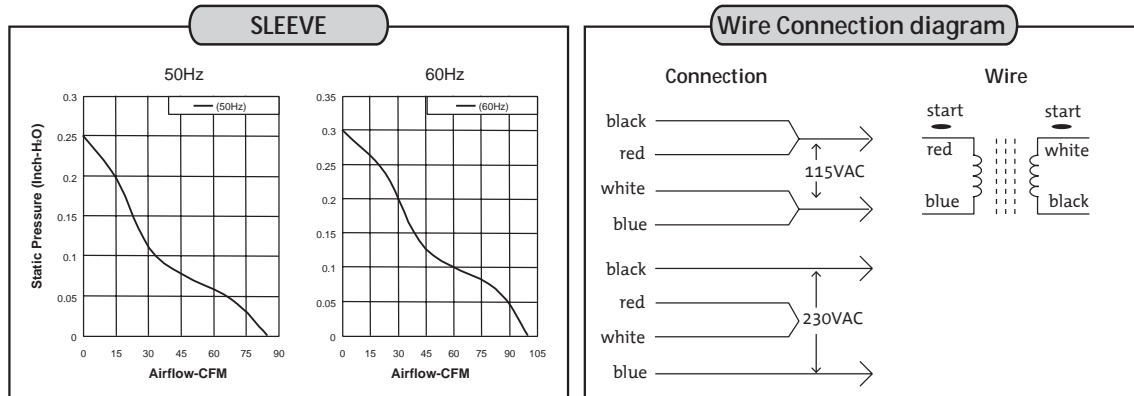

120x120x38 mm (Dual AC voltage)

Bearing Type : Ball / Sleeve bearing

Air Flow:95-115 CFM

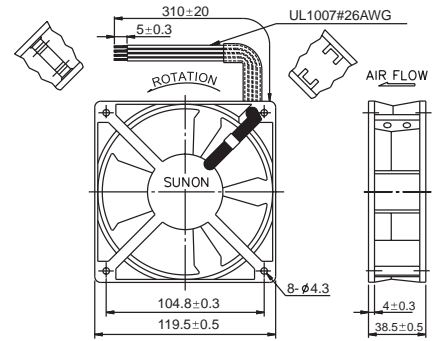
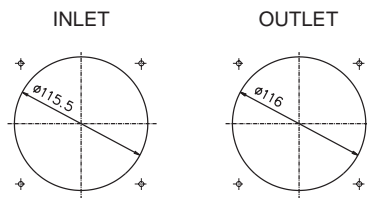

AC Series

Model	P/N	Bearing ⊙ SLEEVE ○ BALL	Rating Voltage (VAC)	Freq. (Hz)	Power Current (AMP)	Power Consumption (WATTS)	Speed (RPM)	Air Flow (CFM)	Static Pressure (Inch-H ₂ O)	Noise (dBA)	Weight (g)
SF1212AD	ST	⊙	115	50/60	0.27/0.24	21.5/19	2700/3100	95/115	0.33/0.38	44/49	550
			230	50/60	0.13/0.12	19.5/19	2700/3100	95/115	0.33/0.38	44/49	550
SF1212AD	SL	⊙	115	50/60	0.27/0.24	21.5/19	2700/3100	95/115	0.33/0.38	44/49	550
			230	50/60	0.13/0.12	19.5/19	2700/3100	95/115	0.33/0.38	44/49	550
SF1212AD	BT	○	115	50/60	0.27/0.24	21.5/19	2700/3100	95/115	0.33/0.38	44/49	550
			230	50/60	0.13/0.12	19.5/19	2700/3100	95/115	0.33/0.38	44/49	550
SF1212AD	BL	○	115	50/60	0.27/0.24	21.5/19	2700/3100	95/115	0.33/0.38	44/49	550
			230	50/60	0.13/0.12	19.5/19	2700/3100	95/115	0.33/0.38	44/49	550

Frame : Aluminum alloy

Specifications subject to change without notice

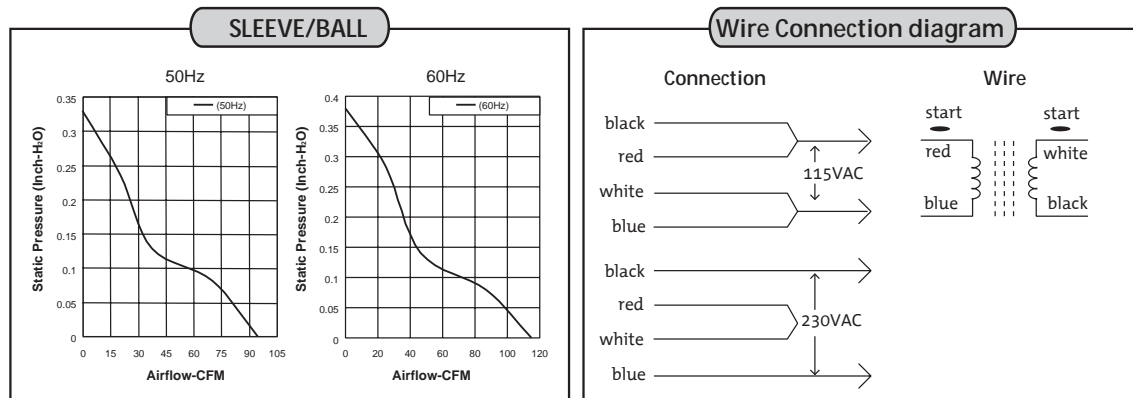

120x38 mm (Skeleton AC Fan)

Bearing Type :Ball / Sleeve bearing
 Air Flow:80-112 CFM

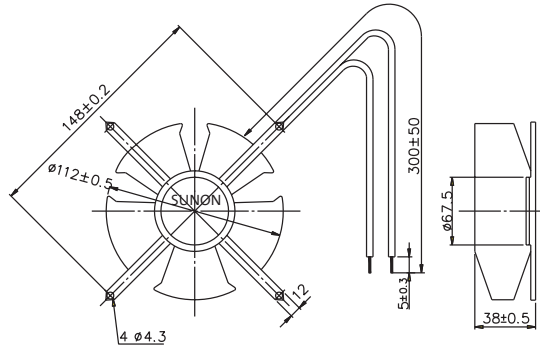

AC Series

Model	P/N	Bearing ⊙ SLEEVE ○ BALL	Rating Voltage (VAC)	Freq. (Hz)	Power Current (AMP)	Power Consumption (WATTS)	Speed (RPM)	Air Flow (CFM)	Static Pressure (Inch-HzO)	Noise (dBA)	Weight (g)
SP100-4F	1123XSL	⊙	115	50/60	0.26/0.24	22/20	2600/3000	92/110	0.32/0.36	43/48	435
SP100-4F	1123XBL	○	115	50/60	0.26/0.24	22/20	2700/3100	94/112	0.33/0.37	44/49	435
SP101-4F	1123HSL	⊙	115	50/60	0.21/0.18	14/13	2300/2800	80/105	0.25/0.32	39/45	435
SP101-4F	1123HBL	○	115	50/60	0.21/0.18	14/13	2400/2900	82/107	0.26/0.33	40/46	435
DP200-4F	2123XSL	⊙	220/240	50/60	0.14/0.12	22/21	2600/3000	92/110	0.32/0.36	43/48	435
DP200-4F	2123XBL	○	220/240	50/60	0.14/0.12	22/21	2700/3100	94/112	0.33/0.37	44/49	435
DP201-4F	2123HSL	⊙	220/240	50/60	0.125/0.11	20/19	2500/2800	82/107	0.26/0.33	39/45	435
DP201-4F	2123HBL	○	220/240	50/60	0.125/0.11	20/19	2500/2800	82/107	0.26/0.33	40/46	435

Frame : Aluminum alloy

Specifications subject to change without notice

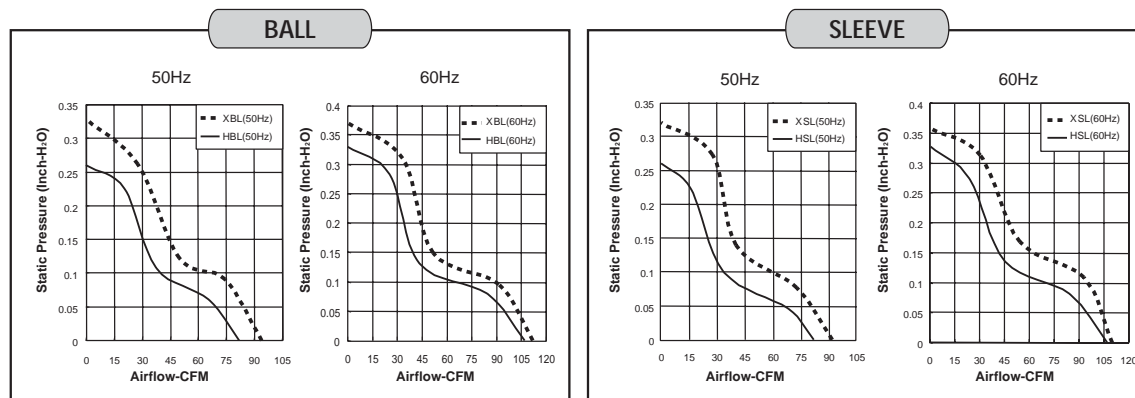

172x151x51 mm

Bearing Type :Ball bearing
Air Flow:178-239CFM



>> P/N:TC

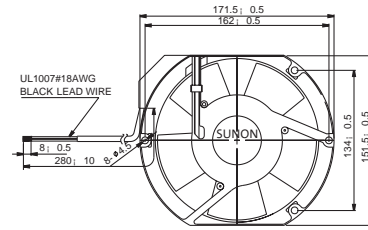
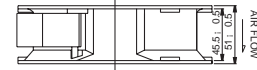
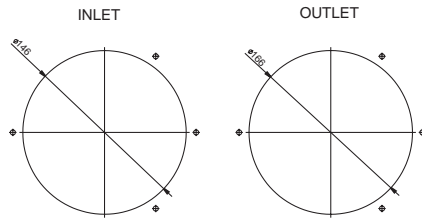

>> P/N: BLANK , P/N:T

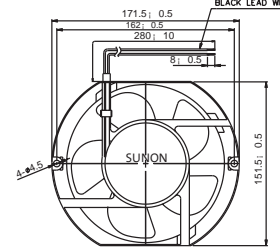
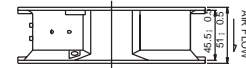
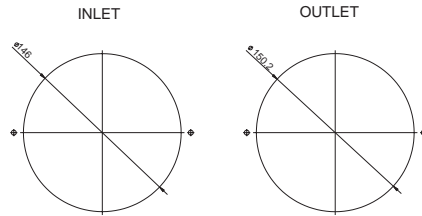

AC Series

Model	P/N	Bearing ○ SLEEVE ○ BALL	Rating Voltage (VAC)	Freq. (Hz)	Power Current (AMP)	Power Consumption (WATTS)	Speed (RPM)	Air Flow (CFM)	Static Pressure (Inch-H ₂ O)	Noise (dBA)	Weight (g)
A1175-HBL	TC	○	115	50/60	0.22/0.23	25/27	2800/3200	203/239	0.62/0.69	51/58	908
A1175-HBT	TC	○	115	50/60	0.22/0.23	25/27	2800/3200	203/239	0.62/0.69	51/58	908
A2175-HBL	TC	○	230	50/60	0.11/0.11	25/26	2800/3200	203/239	0.62/0.69	51/58	908
A2175-HBT	TC	○	230	50/60	0.11/0.11	25/26	2800/3200	203/239	0.62/0.69	51/58	908
A3175-HBL	TC	○	380	50/60	0.06/0.06	20/20	2800/3200	203/239	0.62/0.69	51/58	908
A3175-HBT	TC	○	380	50/60	0.06/0.06	20/20	2800/3200	203/239	0.62/0.69	51/58	908
A1175-HBL	T	○	115	50/60	0.65/0.54	47/41	2650/2950	180/200	0.48/0.48	52/55	942
A1175-HBT	T	○	115	50/60	0.65/0.54	47/41	2650/2950	180/200	0.48/0.48	52/55	942
A2175-HBL	T	○	230	50/60	0.25/0.22	39/36	2600/2800	178/192	0.38/0.44	52/54	942
A2175-HBT	T	○	230	50/60	0.25/0.22	39/36	2600/2800	178/192	0.38/0.44	52/54	942
A1175-HBL		○	115	50/60	0.65/0.54	47/41	2650/2950	180/200	0.48/0.48	52/55	942
A1175-HBT		○	115	50/60	0.65/0.54	47/41	2650/2950	180/200	0.48/0.48	52/55	942
A2175-HBL		○	230	50/60	0.25/0.22	39/36	2600/2800	178/192	0.38/0.44	52/54	942
A2175-HBT		○	230	50/60	0.25/0.22	39/36	2600/2800	178/192	0.38/0.44	52/54	942

Frame : Aluminum alloy

Specifications subject to change without notice

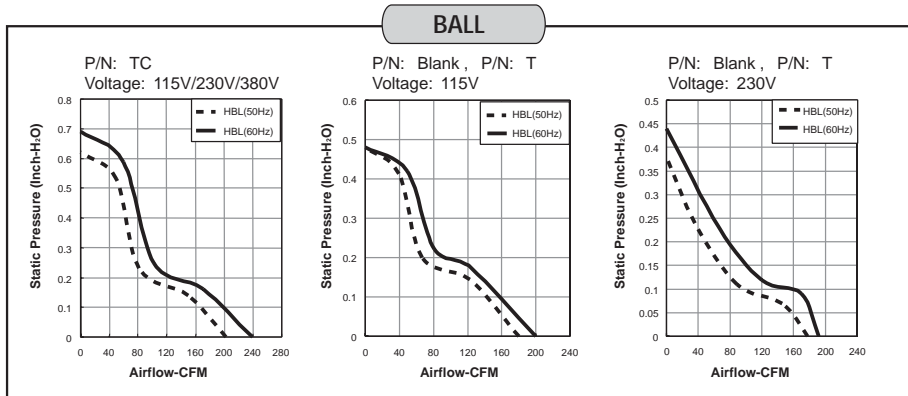

Ø 172x51 mm

Bearing Type :Ball bearing

Air Flow:203-239CFM

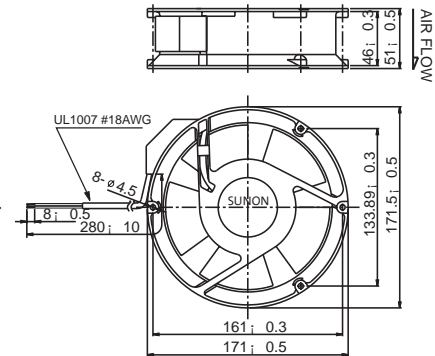
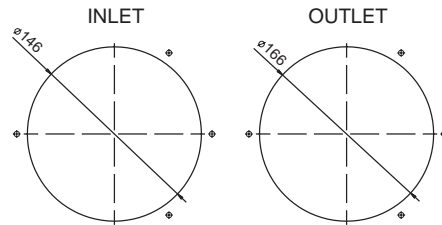

AC Series

Model	P/N	Bearing ⊙ SLEEVE ○ BALL	Rating Voltage (VAC)	Freq. (Hz)	Power Current (AMP)	Power Consumption (WATTS)	Speed (RPM)	Air Flow (CFM)	Static Pressure (Inch-H ₂ O)	Noise (dBA)	Weight (g)
A1175-HBL	TC.R	○	115	50/60	0.22/0.23	25/27	2800/3200	203/239	0.62/0.69	51/58	908
A1175-HBT	TC.R	○	115	50/60	0.22/0.23	25/27	2800/3200	203/239	0.62/0.69	51/58	908
A2175-HBL	TC.R	○	230	50/60	0.11/0.11	25/26	2800/3200	203/239	0.62/0.69	51/58	908
A2175-HBT	TC.R	○	230	50/60	0.11/0.11	25/26	2800/3200	203/239	0.62/0.69	51/58	908
A3175-HBL	TC.R	○	380	50/60	0.06/0.06	20/20	2800/3200	203/239	0.62/0.69	51/58	908
A3175-HBT	TC.R	○	380	50/60	0.06/0.06	20/20	2800/3200	203/239	0.62/0.69	51/58	908

Frame : Aluminum alloy

Specifications subject to change without notice

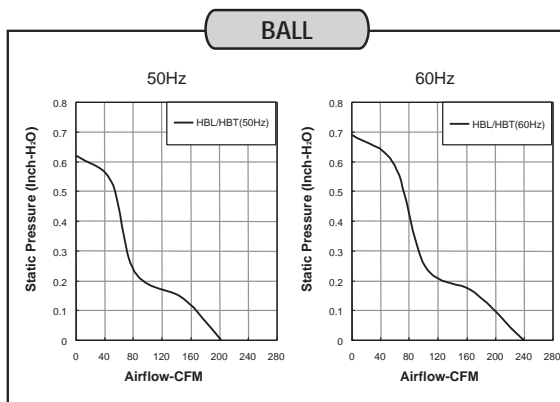

176x176x89 mm

Bearing Type : Ball bearing
Air Flow:315-355 CFM

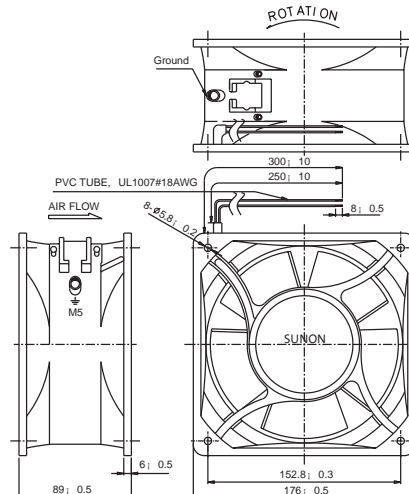
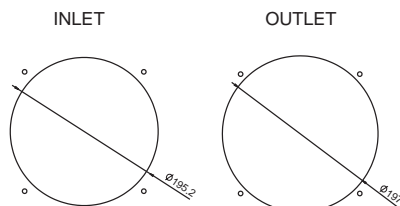

AC Series



Model	P/N	Bearing ○ SLEEVE ○ BALL	Rating Voltage (VAC)	Freq. (Hz)	Power Current (AMP)	Power Consumption (WATTS)	Speed (RPM)	Air Flow (CFM)	Static Pressure (Inch-H ₂ O)	Noise (dBA)	Weight (g)
A1179-HBT	TC	○	115	50/60	0.25/0.27	24/30	2800/3250	315/355	0.65/0.8	62/66	1960

Frame : Aluminum alloy

Specifications subject to change without notice

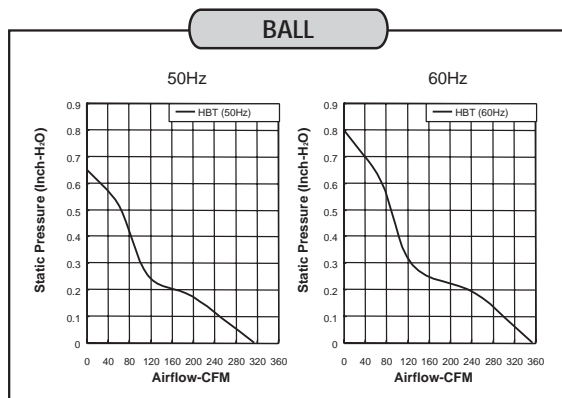

Ø 254x89 mm

Bearing Type :Ball bearing
Air Flow:600-850CFM

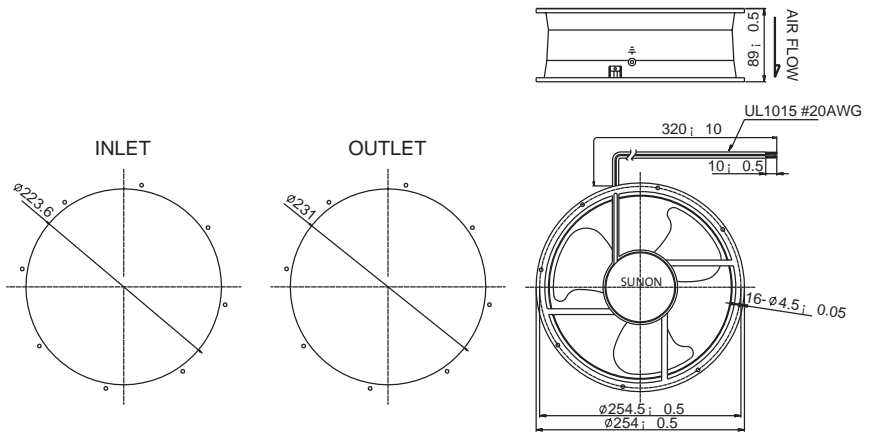

AC Series

Model	P/N	Bearing ○ SLEEVE ○ BALL	Rating Voltage (VAC)	Freq. (Hz)	Power Current (AMP)	Power Consumption (WATTS)	Speed (RPM)	Air Flow (CFM)	Static Pressure (Inch-H ₂ O)	Noise (dBA)	Weight (g)
A1259-MBL	TC	○	115	50/60	0.23/0.23	26/23	1400/1600	600/665	0.27/0.36	50/52	2000
A1259-MBT	TC	○	115	50/60	0.23/0.23	26/23	1400/1600	600/665	0.27/0.36	50/52	2000
A2259-HBL	TC	○	230	50/60	0.24/0.27	56/60	2100/1900	850/770	0.40/0.38	57/55	2000
A2259-HBT	TC	○	230	50/60	0.24/0.27	56/60	2100/1900	850/770	0.40/0.38	57/55	2000
A2259-MBL	TC	○	230	50/60	0.15/0.13	30/30	1400/1600	600/665	0.27/0.36	50/52	2000
A2259-MBT	TC	○	230	50/60	0.15/0.13	30/30	1400/1600	600/665	0.27/0.36	50/52	2000

Frame : Aluminum alloy

Specifications subject to change without notice

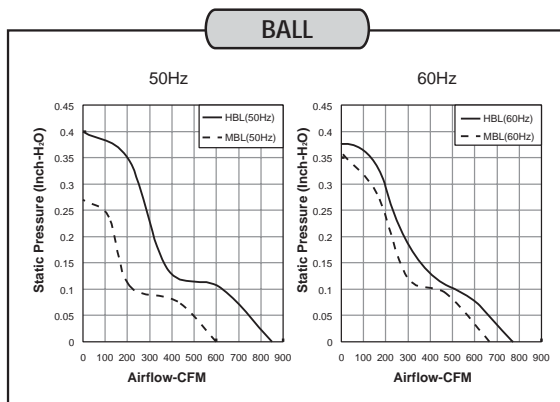

ACCESSORIES

METAL FINGER GUARD

FG-08 For 80mm Fan

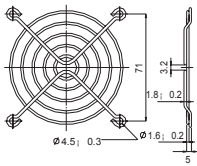

FG-09 For 92mm Fan

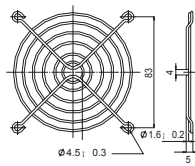

FG-12 For 120mm Fan

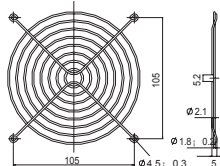

FG-17 For 172mm Fan

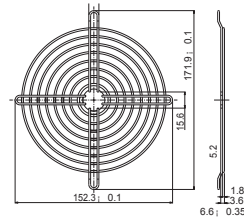

FG-25 For 254mm Fan

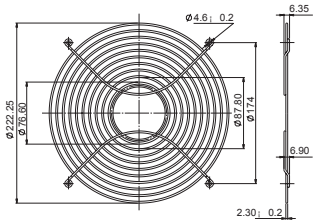

METAL FILTER GUARD

FM 06 For 60mm Fan

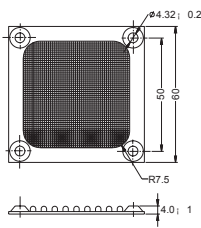

FM 08 For 80mm Fan

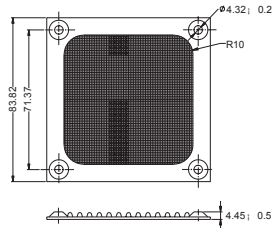

FM 09 For 92mm Fan

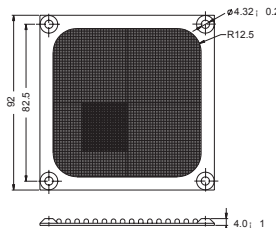

FM 12 For 120mm Fan

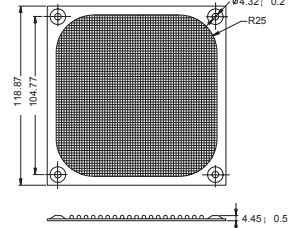

PLASTIC GUARD

PB-06 For 60mm Fan

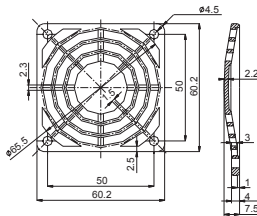

PB-08 For 80mm Fan

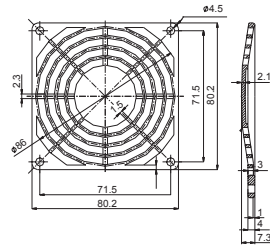

PB-09 For 92mm Fan

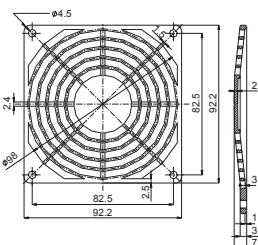

PB-12 For 120mm Fan

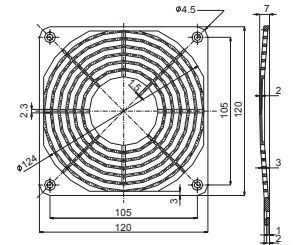

PLASTIC FILTER GUARD

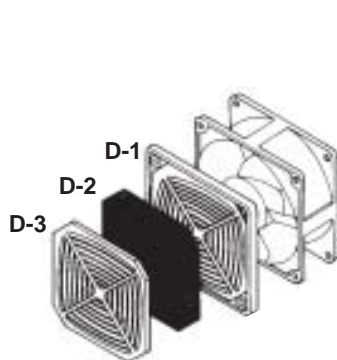

D-1 Finger Guard

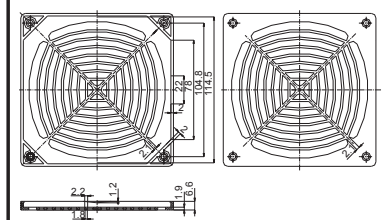

D-2 Filter

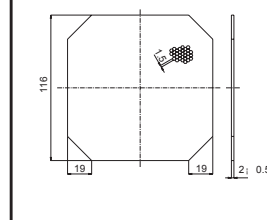

D-3 Remainer

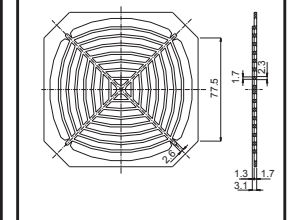

ACCESSORIES

AC CORD

Power cord with straight connector

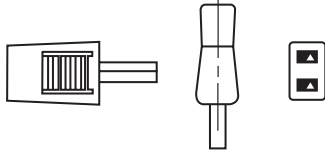

A2-03	300mm Length
A2-06	600mm Length
A2-10	1000mm Length
A2-20	2000mm Length

