



FC031 Series

Axial

Ø 324mm

- AC fans with external rotor motor. Blades permanently attached to the motor for optimum motor cooling and reliable long life operation.
- Cast aluminum blades, formed steel housing.
- Square mounting plate using four 9 mm holes. Ready to install.
- Electrical connection via cable or terminal box. Capacitor included.
- UL, CSA, VDE approvals on some models, please contact application engineering.

Part Number	Curve	CFM @ 0	VAC	Hertz	Power (W)	dBa	Max Amb. Temp C	Bearing Type	Features	Capacitor (µF)	Grill Position	Wgt. (lbs)
FC031-6/205405	1	880	115	50/60	100	58	50	Ball	Leads	8	Intake	12.0
FC031-4/201648	2	1300	115	60	160	66	40	Ball	Leads	12	Intake	12.0
FC031-6/124632	1	880	230	50/60	100	58	50	Ball	Leads	2	Intake	12.0
FC031-4/105119	2	1300	230	60	160	66	40	Ball	Leads	3	Intake	12.0

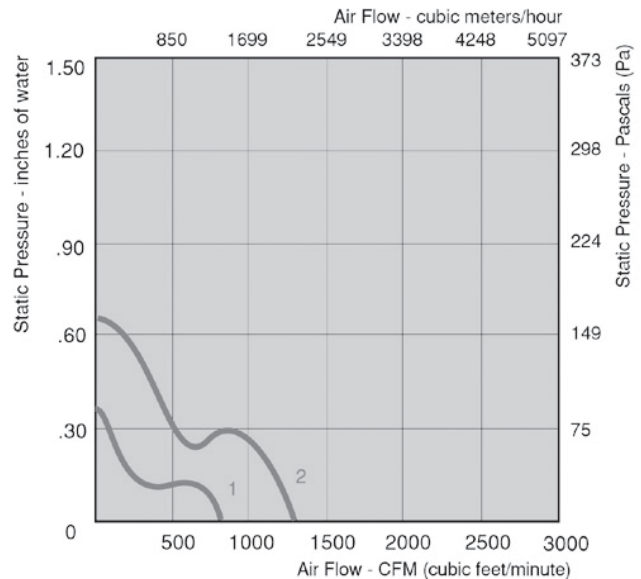
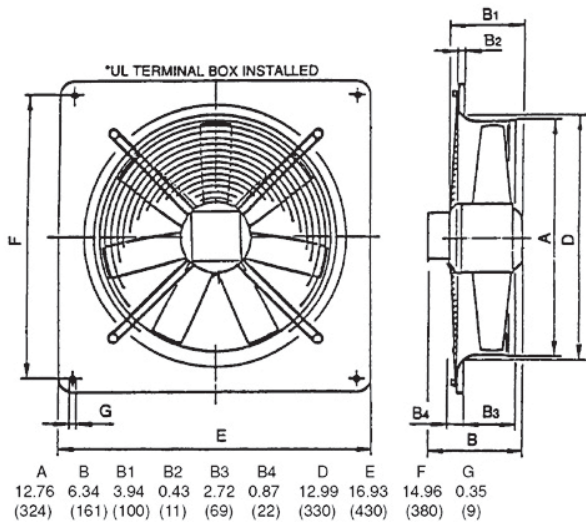

ebmpapst

e-mail: sales@us.ebmpapst.com - TEL: 860-674-1515 - FAX: 860-674-8536

ebm-papst Inc., 100 Hyde Road, Farmington, CT 06034 USA

ebm-papst Inc., 2004 © ebm-papst Inc. reserves the right to change any specifications or data without notice