

## High Speed Dual Comparator

### General Description

The LM119 is a precision high speed dual comparator fabricated on a single monolithic chip. It is designed to operate over a wide range of supply voltages down to a single 5V logic supply and ground. Further, it has higher gain and lower input currents than devices such as the LM710. The uncommitted collector of the output stage makes the LM119 compatible with RTL, DTL and TTL as well as capable of driving lamps and relays at currents up to 25 mA.

Although designed primarily for applications requiring operation from digital logic supplies, the LM119 is fully specified for power supplies up to  $\pm 15V$ . It features faster response than the LM111 at the expense of higher power dissipation. However, the high speed, wide operating voltage range and low package count make the LM119 much more versatile than older devices such as the LM711.

### Features

- Two independent comparators
- Operates from a single 5V supply
- Typically 80 ns response time at  $\pm 15V$
- Minimum fan-out of 2 each side
- Maximum input current of 1  $\mu A$  over temperature
- Inputs and outputs can be isolated from system ground
- High common mode slew rate

### Ordering Information

NS Part Number	JAN Part Number	NS Package Number	Package Description
JL119BIA	JM38510/10306BIA	H10C	10LD T0-100 Metal Can
JL119BCA	JM38510/10306BCA	J14A	14LD CERDIP

### Connection Diagrams

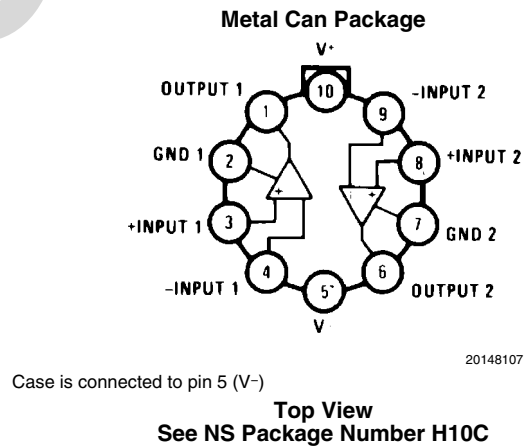
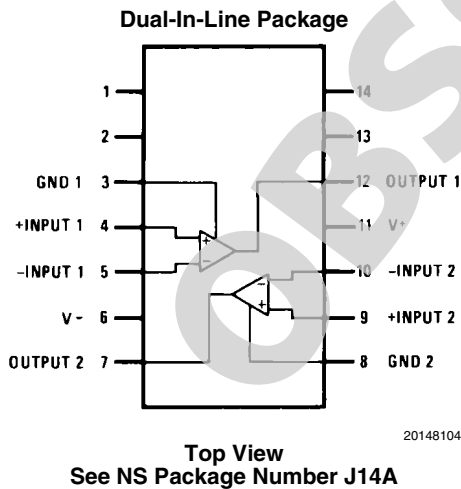

## Schematic Diagram

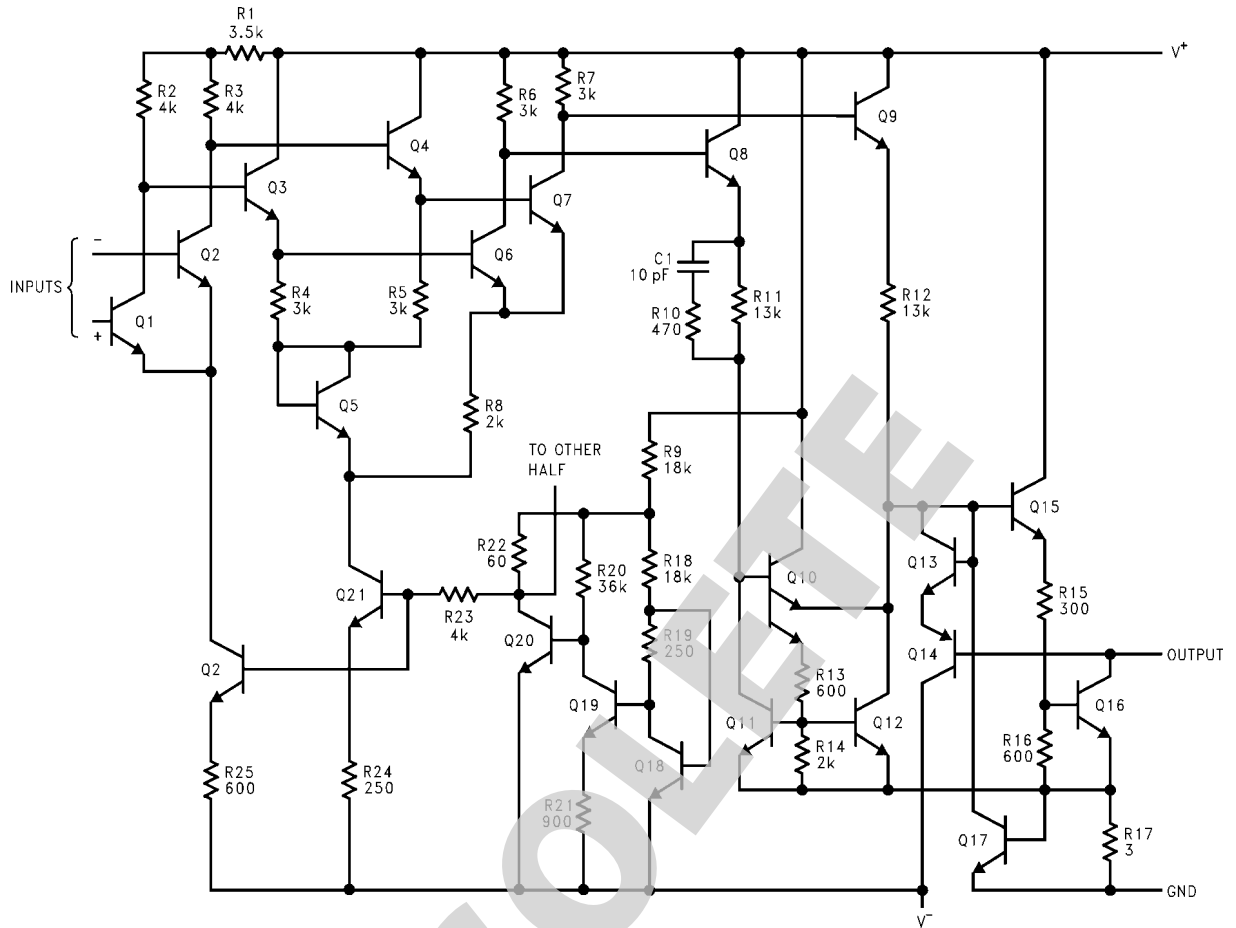

\*Do not operate the LM119 with more than 16V between GND and V+

20148101

## Absolute Maximum Ratings *(Note 1)*

Total Supply Voltage	36V
Output to Negative Supply Voltage	36V
Ground to Negative Supply Voltage	25V
Ground to Positive Supply Voltage	18V
Differential Input Voltage	±5V
Input Voltage <i>(Note 3)</i>	±15V
Power Dissipation <i>(Note 2)</i>	500 mW
Output Short Circuit Duration	10 sec
Storage Temperature Range	-65°C ≤ T <sub>A</sub> ≤ 150°C
Operating Ambient Temperature Range	-55°C ≤ T <sub>A</sub> ≤ 125°C
Maximum Junction Temperature (T <sub>J</sub> )	150°C
Lead Temperature (Soldering, 10 sec.)	260°C
Thermal Resistance	
θ <sub>JA</sub>	
H Package (Still Air)	162°C/W
H Package (500LF/Min Air flow)	88°C/W
J Package (Still Air)	94°C/W
J Package (500LF/Min Air flow)	52°C/W
θ <sub>JC</sub>	
H Package	31°C/W
J Package	11°C/W
Package Weight	
H Package	TBD
J Package	TBD
ESD rating <i>(Note 4)</i>	800V

## Quality Conformance Inspection

Mil-Std-883, Method 5005 - Group A

Subgroup	Description	Temp °C
1	Static tests at	25
2	Static tests at	125
3	Static tests at	-55
4	Dynamic tests at	25
5	Dynamic tests at	125
6	Dynamic tests at	-55
7	Functional tests at	25
8A	Functional tests at	125
8B	Functional tests at	-55
9	Switching tests at	25
10	Switching tests at	125
11	Switching tests at	-55
12	Settling time at	25
13	Settling time at	125
14	Settling time at	-55

## Electrical Characteristics

### DC Parameters

Symbol	Parameter	Conditions	Notes	Min	Max	Unit	Sub-groups
$V_{IO}$	Input Offset Voltage	$+V_{CC} = 15V, -V_{CC} = -15V,$ $V_{CM} = 0V, R_S = 50\Omega$		-4.0	4.0	mV	1
				-7.0	7.0	mV	2, 3
		$+V_{CC} = 27V, -V_{CC} = -3V,$ $V_{CM} = -12V, R_S = 50\Omega$		-4.0	4.0	mV	1
				-7.0	7.0	mV	2, 3
		$+V_{CC} = 3V, -V_{CC} = -27V,$ $V_{CM} = 12V, R_S = 50\Omega$		-4.0	4.0	mV	1
				-7.0	7.0	mV	2, 3
$I_{IO}$	Input Offset Current	$+V_{CC} = 15V, -V_{CC} = -15V,$ $V_{CM} = 0V$		-75	+75	nA	1, 2
				-100	+100	nA	3
		$+V_{CC} = 27V, -V_{CC} = -3V,$ $V_{CM} = -12V$		-75	+75	nA	1, 2
				-100	+100	nA	3
		$+V_{CC} = 3V, -V_{CC} = -27V,$ $V_{CM} = 12V$		-75	+75	nA	1, 2
				-100	+100	nA	3
$+I_{CC}$	Power Supply Current	$+V_{CC} = 15V, -V_{CC} = -15V$			10	mA	1, 2
					11.5	mA	3
$-I_{CC}$	Power Supply Current	$+V_{CC} = 15V, -V_{CC} = -15V$		-5.0		mA	1
				-4.5		mA	2
				-6.0		mA	3
$\pm I_{IB}$	Input Bias Current	$+V_{CC} = 15V, -V_{CC} = -15V,$ $V_{CM} = 0V$		-0.1	500	nA	1, 2
				-0.1	1000	nA	3
		$+V_{CC} = 27V, -V_{CC} = -3V,$ $V_{CM} = -12V$		-0.1	750	nA	1, 2
				-0.1	1000	nA	3
		$+V_{CC} = 3V, -V_{CC} = -27V,$ $V_{CM} = 12V$		-0.1	750	nA	1, 2
				-0.1	1000	nA	3
CMRR	Common Mode Rejection	$-12V \leq V_{CM} \leq +12V,$ $-27V \leq -V_{CC} \leq -3V,$ $3V \leq +V_{CC} \leq 27V, R_S = 50\Omega$		90		dB	1, 2, 3
$V_{OL}$	Low Level Output Voltage	$+V_{CC} = 3.5V, -V_{CC} = -1V,$ $V_{CM} = 1V, V_{IO} = 7mV,$ $I_O = 3.2mA$			0.4	V	1, 2
					0.6	V	3
		$+V_{CC} = 2.25V, -V_{CC} = -2.25V,$ $V_{CM} = 2.25V, V_{IO} = 7mV,$ $I_O = 3.2mA$			0.4	V	1, 2
					0.6	V	3
		$+V_{CC} = 27V, -V_{CC} = -3V,$ $V_{CM} = -12V, V_{IO} = 7mV,$ $I_O = 25mA$			1.5	V	1, 2, 3
$+V_{CC} = 3V, -V_{CC} = -27V,$ $V_{CM} = 12V, V_{IO} = 7mV,$ $I_O = 25mA$			1.5	V	1, 2, 3		
$I_{CEX}$	Output Leakage Current	$+V_{CC} = 18V, -V_{CC} = -18V,$ $V_O = 18V$		-1.0	2.0	$\mu A$	1
				-1.0	10	$\mu A$	2
$A_V$	Voltage Gain (Collector)	$+V_{CC} = 15V, -V_{CC} = -15V,$ $V_O = 1.5V \text{ to } 11.5V$	(Note 5)	10		K	4
			(Note 5)	5.0		K	5, 6

## AC Parameters

The following conditions apply to all the following parameters, unless otherwise specified.

AC:  $\pm 15V$ ,  $C_L = 50pF$

Symbol	Parameter	Conditions	Notes	Min	Max	Unit	Sub-groups
$t_{R_{LHC}}$	Response Time (Collector Output)	$V_{OD}$ (overdrive) = +5mV, $V_I = 100mV$			125	nS	9
$t_{R_{HLC}}$	Response Time (Collector Output)	$V_{OD}$ (overdrive) = -5mV, $V_I = 100mV$			160	nS	9

## DC Drift Parameters

Delta calculations performed at Group B-5

Symbol	Parameter	Conditions	Notes	Min	Max	Unit	Sub-groups
$V_{IO}$	Input Offset Voltage	$+V_{CC} = 15V, -V_{CC} = -15V,$ $V_{CM} = 0V, R_S = 50\Omega$		-1.0	1.0	mV	1
		$+V_{CC} = 27V, -V_{CC} = -3V,$ $V_{CM} = -12V, R_S = 50\Omega$		-1.0	1.0	mV	1
		$+V_{CC} = 3V, -V_{CC} = -27V,$ $V_{CM} = 12V, R_S = 50\Omega$		-1.0	1.0	mV	1
$\pm I_{IB}$	Input Bias Current	$+V_{CC} = 15V, -V_{CC} = -15V,$ $V_{CM} = 0V$		-50	50	nA	1
		$+V_{CC} = 27V, -V_{CC} = -3V,$ $V_{CM} = -12V$		-50	50	nA	1
		$+V_{CC} = 3V, -V_{CC} = -27V,$ $V_{CM} = 12V$		-50	50	nA	1

**Note 1:** Absolute Maximum Ratings indicate limits beyond which damage to the device may occur. Operating Ratings indicate conditions for which the device is functional, but do not guarantee specific performance limits. For guaranteed specifications and test conditions, see the Electrical Characteristics. The guaranteed specifications apply only for the test conditions listed. Some performance characteristics may degrade when the device is not operated under the listed test conditions.

**Note 2:** The maximum power dissipation must be derated at elevated temperatures and is dictated by  $T_{Jmax}$  (maximum junction temperature),  $\theta_{JA}$  (package junction to ambient thermal resistance), and  $T_A$  (ambient temperature). The maximum allowable power dissipation at any temperature is  $P_{Dmax} = (T_{Jmax} - T_A) / \theta_{JA}$  or the number given in the Absolute Maximum Ratings, whichever is lower.

**Note 3:** For supply voltages less than  $\pm 15V$  the absolute maximum input voltage is equal to the supply voltage.

**Note 4:** Human Body model, 1.5k $\Omega$  in series with 100pF.

**Note 5:** K = V/mV.

# Typical Performance Characteristics

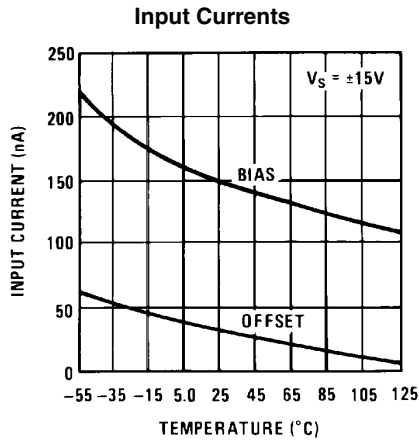

20148110

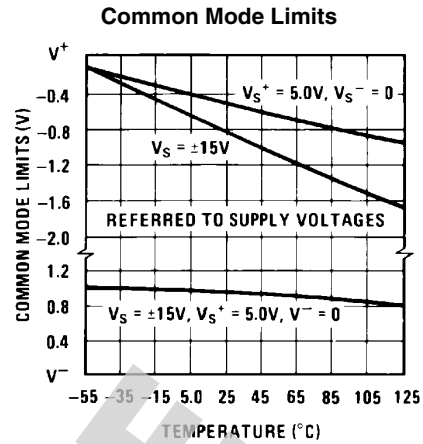

20148111

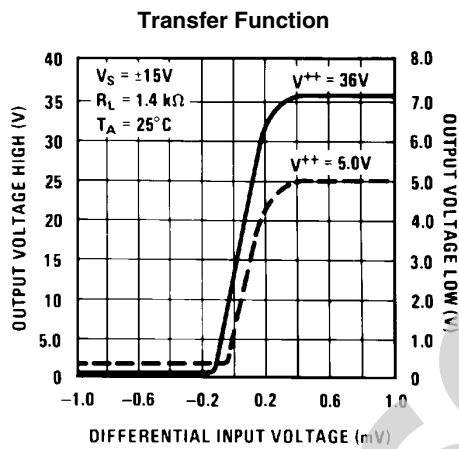

20148112

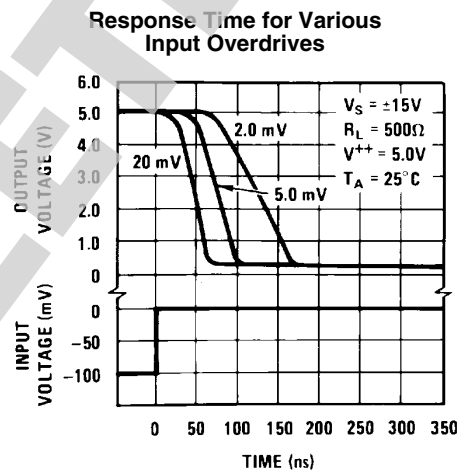

20148113

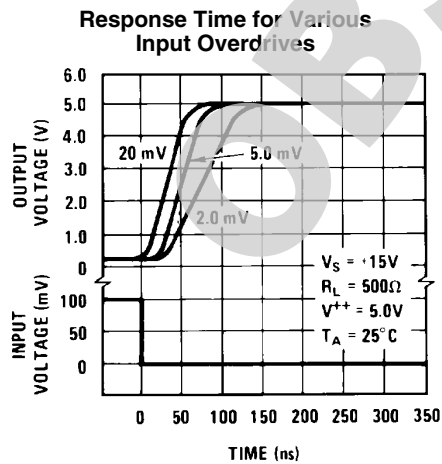

20148114

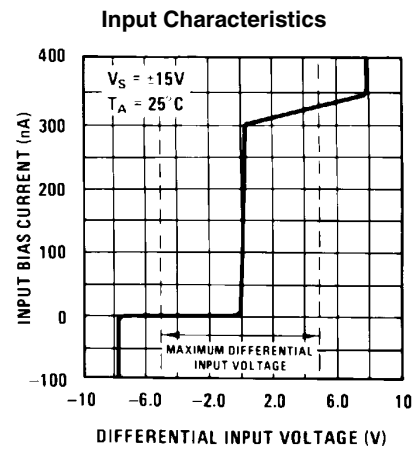

20148115

Response Time for Various Input Overdrives

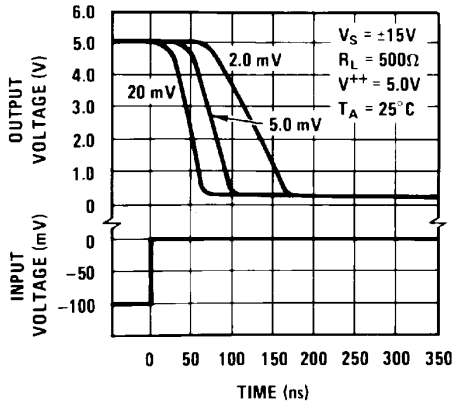

20148116

Response Time for Various Input Overdrives

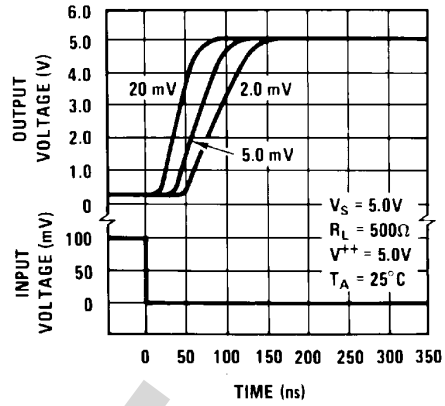

20148117

Output Saturation Voltage

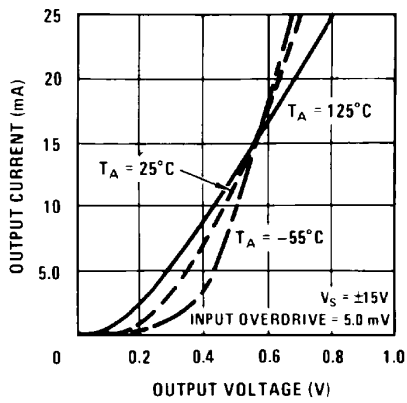

20148118

Supply Current

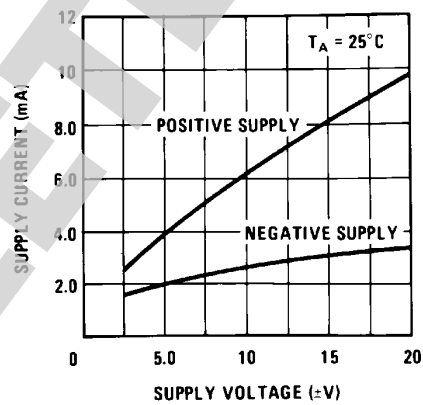

20148119

Supply Current

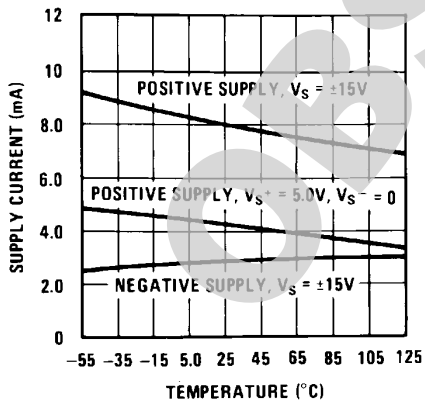

20148120

Output Limiting Characteristics

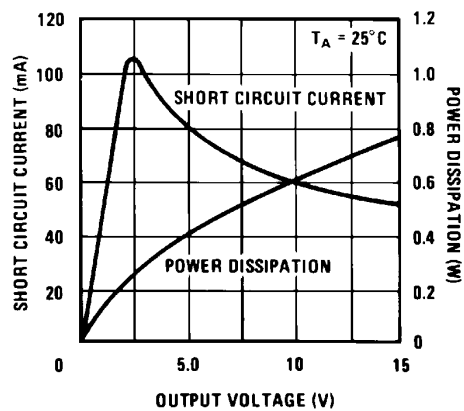

20148121

## Typical Applications (Note Pin numbers are for metal can package.)

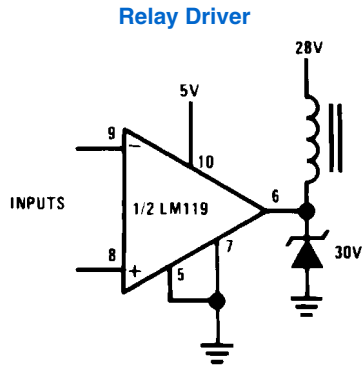

20148105

**Note 6:** Pin numbers are for metal can package.

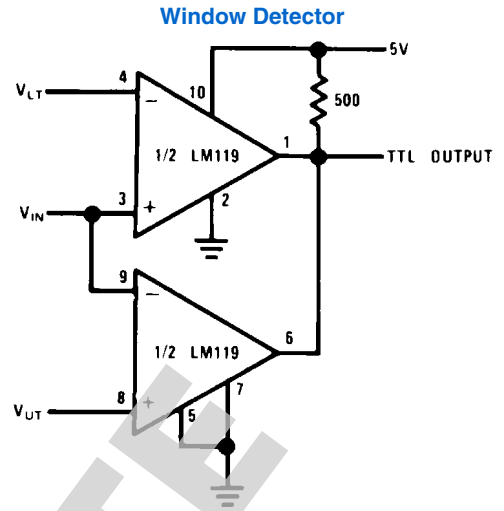

20148106

$$V_{OUT} = 5V \text{ for } V_{LT} \leq V_{IN} \leq V_{UT}$$

$$V_{OUT} = 0 \text{ for } V_{IN} \leq V_{LT} \text{ or } V_{IN} \geq V_{UT}$$

OBSOLETE



## Revision History Section

Date Released	Revision	Section	Changes
7/0105	A	New release to corporate format	1 MDS datasheet converted into one corporate data sheet format MJLM119-X Rev. 0BL will be archived.
09/24/2010	B	Obsolete Data Sheet	Revision B, End of Life on Product/NSID Dec. 2009 Obsolete Data Sheet

OBSOLETE

**Physical Dimensions** inches (millimeters) unless otherwise noted

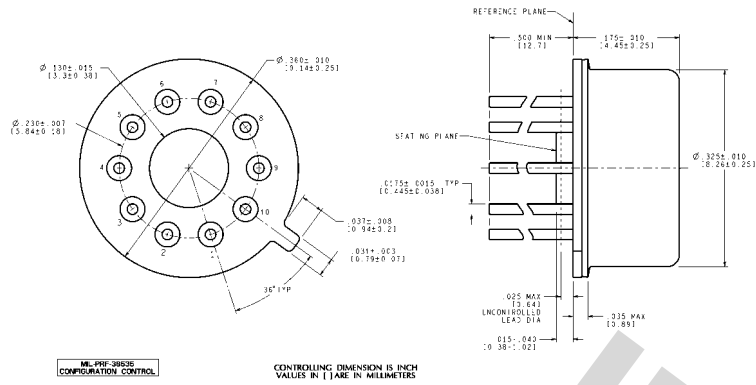

ML-PHF-39836  
CONFIGURATION CONTROL

CONTROLLING DIMENSION IS INCH  
VALUES IN [ ] ARE IN MILLIMETERS

H10C (Rev G)

**Metal Can Package (H)  
NS Package Number H10C**

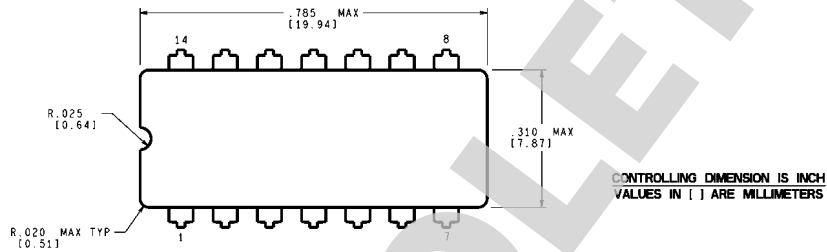

CONTROLLING DIMENSION IS INCH  
VALUES IN [ ] ARE MILLIMETERS

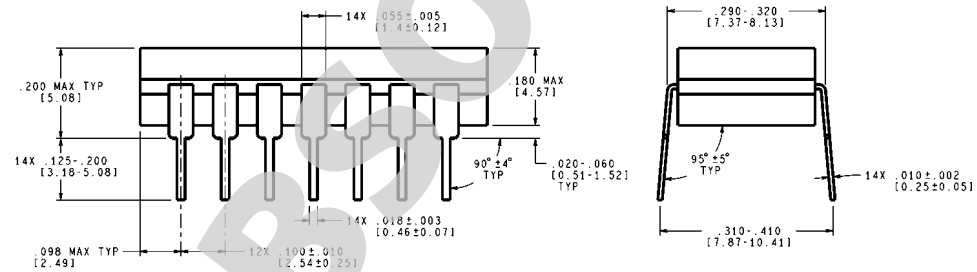

**Cavity Dual-In-Line Package (J)  
NS Package Number J14A**

J14A (Rev J)

## Notes

LM119JAN

**OBSOLETE**

## Notes

For more National Semiconductor product information and proven design tools, visit the following Web sites at:  
[www.national.com](http://www.national.com)

Products		Design Support	
Amplifiers	<a href="http://www.national.com/amplifiers">www.national.com/amplifiers</a>	WEBENCH® Tools	<a href="http://www.national.com/webench">www.national.com/webench</a>
Audio	<a href="http://www.national.com/audio">www.national.com/audio</a>	App Notes	<a href="http://www.national.com/appnotes">www.national.com/appnotes</a>
Clock and Timing	<a href="http://www.national.com/timing">www.national.com/timing</a>	Reference Designs	<a href="http://www.national.com/refdesigns">www.national.com/refdesigns</a>
Data Converters	<a href="http://www.national.com/adc">www.national.com/adc</a>	Samples	<a href="http://www.national.com/samples">www.national.com/samples</a>
Interface	<a href="http://www.national.com/interface">www.national.com/interface</a>	Eval Boards	<a href="http://www.national.com/evalboards">www.national.com/evalboards</a>
LVDS	<a href="http://www.national.com/lvds">www.national.com/lvds</a>	Packaging	<a href="http://www.national.com/packaging">www.national.com/packaging</a>
Power Management	<a href="http://www.national.com/power">www.national.com/power</a>	Green Compliance	<a href="http://www.national.com/quality/green">www.national.com/quality/green</a>
Switching Regulators	<a href="http://www.national.com/switchers">www.national.com/switchers</a>	Distributors	<a href="http://www.national.com/contacts">www.national.com/contacts</a>
LDOs	<a href="http://www.national.com/ldo">www.national.com/ldo</a>	Quality and Reliability	<a href="http://www.national.com/quality">www.national.com/quality</a>
LED Lighting	<a href="http://www.national.com/led">www.national.com/led</a>	Feedback/Support	<a href="http://www.national.com/feedback">www.national.com/feedback</a>
Voltage References	<a href="http://www.national.com/vref">www.national.com/vref</a>	Design Made Easy	<a href="http://www.national.com/easy">www.national.com/easy</a>
PowerWise® Solutions	<a href="http://www.national.com/powerwise">www.national.com/powerwise</a>	Applications & Markets	<a href="http://www.national.com/solutions">www.national.com/solutions</a>
Serial Digital Interface (SDI)	<a href="http://www.national.com/sdi">www.national.com/sdi</a>	Mil/Aero	<a href="http://www.national.com/milaero">www.national.com/milaero</a>
Temperature Sensors	<a href="http://www.national.com/tempensors">www.national.com/tempensors</a>	SolarMagic™	<a href="http://www.national.com/solarmagic">www.national.com/solarmagic</a>
PLL/VCO	<a href="http://www.national.com/wireless">www.national.com/wireless</a>	PowerWise® Design University	<a href="http://www.national.com/training">www.national.com/training</a>

THE CONTENTS OF THIS DOCUMENT ARE PROVIDED IN CONNECTION WITH NATIONAL SEMICONDUCTOR CORPORATION ("NATIONAL") PRODUCTS. NATIONAL MAKES NO REPRESENTATIONS OR WARRANTIES WITH RESPECT TO THE ACCURACY OR COMPLETENESS OF THE CONTENTS OF THIS PUBLICATION AND RESERVES THE RIGHT TO MAKE CHANGES TO SPECIFICATIONS AND PRODUCT DESCRIPTIONS AT ANY TIME WITHOUT NOTICE. NO LICENSE, WHETHER EXPRESS, IMPLIED, ARISING BY ESTOPPEL OR OTHERWISE, TO ANY INTELLECTUAL PROPERTY RIGHTS IS GRANTED BY THIS DOCUMENT.

TESTING AND OTHER QUALITY CONTROLS ARE USED TO THE EXTENT NATIONAL DEEMS NECESSARY TO SUPPORT NATIONAL'S PRODUCT WARRANTY. EXCEPT WHERE MANDATED BY GOVERNMENT REQUIREMENTS, TESTING OF ALL PARAMETERS OF EACH PRODUCT IS NOT NECESSARILY PERFORMED. NATIONAL ASSUMES NO LIABILITY FOR APPLICATIONS ASSISTANCE OR BUYER PRODUCT DESIGN. BUYERS ARE RESPONSIBLE FOR THEIR PRODUCTS AND APPLICATIONS USING NATIONAL COMPONENTS. PRIOR TO USING OR DISTRIBUTING ANY PRODUCTS THAT INCLUDE NATIONAL COMPONENTS, BUYERS SHOULD PROVIDE ADEQUATE DESIGN, TESTING AND OPERATING SAFEGUARDS.

EXCEPT AS PROVIDED IN NATIONAL'S TERMS AND CONDITIONS OF SALE FOR SUCH PRODUCTS, NATIONAL ASSUMES NO LIABILITY WHATSOEVER, AND NATIONAL DISCLAIMS ANY EXPRESS OR IMPLIED WARRANTY RELATING TO THE SALE AND/OR USE OF NATIONAL PRODUCTS INCLUDING LIABILITY OR WARRANTIES RELATING TO FITNESS FOR A PARTICULAR PURPOSE, MERCHANTABILITY, OR INFRINGEMENT OF ANY PATENT, COPYRIGHT OR OTHER INTELLECTUAL PROPERTY RIGHT.

#### LIFE SUPPORT POLICY

**NATIONAL'S PRODUCTS ARE NOT AUTHORIZED FOR USE AS CRITICAL COMPONENTS IN LIFE SUPPORT DEVICES OR SYSTEMS WITHOUT THE EXPRESS PRIOR WRITTEN APPROVAL OF THE CHIEF EXECUTIVE OFFICER AND GENERAL COUNSEL OF NATIONAL SEMICONDUCTOR CORPORATION.** As used herein:

Life support devices or systems are devices which (a) are intended for surgical implant into the body, or (b) support or sustain life and whose failure to perform when properly used in accordance with instructions for use provided in the labeling can be reasonably expected to result in a significant injury to the user. A critical component is any component in a life support device or system whose failure to perform can be reasonably expected to cause the failure of the life support device or system or to affect its safety or effectiveness.

National Semiconductor and the National Semiconductor logo are registered trademarks of National Semiconductor Corporation. All other brand or product names may be trademarks or registered trademarks of their respective holders.

Copyright© 2010 National Semiconductor Corporation

For the most current product information visit us at [www.national.com](http://www.national.com)

 **National Semiconductor Americas Technical Support Center**  
 Email: [support@nsc.com](mailto:support@nsc.com)  
 Tel: 1-800-272-9959

**National Semiconductor Europe Technical Support Center**  
 Email: [europe.support@nsc.com](mailto:europe.support@nsc.com)

**National Semiconductor Asia Pacific Technical Support Center**  
 Email: [ap.support@nsc.com](mailto:ap.support@nsc.com)

**National Semiconductor Japan Technical Support Center**  
 Email: [jpn.feedback@nsc.com](mailto:jpn.feedback@nsc.com)