



GLS Series

Miniature Global limit switch

Features

- Double break, direct opening contacts conform to IEC 60947-5-1-3
- EN50047 Mounting
- Dual bearing design on side rotary shaft
- Your choice of rugged metal or double insulated plastic housings
- Full range of actuator heads and levers
- Snap action, slow action basic switches
- Gold contact versions available
- Galvanically isolated contacts (Form Zb)
- Sealing up to IP67/NEMA 4
- CE, UL, CSA
- -40°C (-40°F) standard construction for side rotary and plunger styles

Benefits

- Forced opening of the normally closed circuit in the event of contacts welding
- Meets globally accepted mounting standards
- Prevents side loading
- Design flexibility
- Can be applied for both logic level and power duty loads
- Each contact throw can accept a different voltage (SPDT versions)
- Suitable for outdoor environments
- Designed to IEC electrical standard for world-wide use

Description

GLS miniature limit switches are designed to provide a complete range of globally approved products. These rugged and reliable limit switches are suitable for most industrial applications.

Side rotary versions offer a unique dual bearing design, which prevents side loading during application. The compact housing size makes them ideal for mounting where space is a premium. The extensive product range offers the user a choice of plastic, metal and three conduit version housings, which are all mounting compatible to EN50047. A wide range of actuator and circuitry options makes it easy for the user to customize a switch to his application.

Typical Applications

- Elevators and moving stairs
- Scissor/platform lifts
- Material Handling
- Packaging machinery
- Agricultural equipment
- Machine tool equipment



Low energy switching

In today's demanding age of low energy controls, electromechanical switches are frequently used to interface directly with PLC's and other low energy devices. To accommodate this requirement GLS offers a gold plated version of the standard basic switch. This improves reliability of switching at low currents and voltages by protecting the contact surfaces from contamination during operation or storage prior to use. Standard silver contracts have the disadvantage in that the contact surface may tarnish under certain environmental conditions e.g. in the presence of moisture.

Low energy basic switches are rated as follows:
 Operating Voltage U_e 1 to 50 Vac or dc
 Operating Current I_e 1 microamp to 100 mA

Electrical Ratings

IEC 947-5-1 / EN 90947-5-1								
Designation & Utilization Category	Rated operational current I_e (A) at rated operational voltage U_e						VA rating	
	120V	240V	380V	480V	500V	600V	Make	Break
AC15 A600	6	3	1.9	1.5	1.4	1.2	7200	720
AC15 A300	6	3	-	-	-	-	7200	720
AC15 B300	3	1.5	-	-	-	-	3600	360
AC14 D300	0.6	0.3	-	-	-	-	432	72
	125V 250V							
DC13 Q300	0.55	0.27					69	69
DC13 R300	0.22	0.1					28	28

GLC EN 50047 Metal standard

Technical data

Mechanical life up to 15 million operations

Degree of protection IP 67 (wobble IP 66)
NEMA/UL type 1, 4, 12, 13

Temperature range Operating : -40°C to +85°C
-40°F to +185°F
Storage : -40°C to +85°C
-40°F to +185°F

Approvals IEC60947-5-1
EN60947-5-1
AC15 A300
DC13 Q300
UL & CSA

Vibration 10 g conforming to IEC 68-2-6

Shock 50 g conforming to IEC 68-2-27
Terminal marking to EN 50013

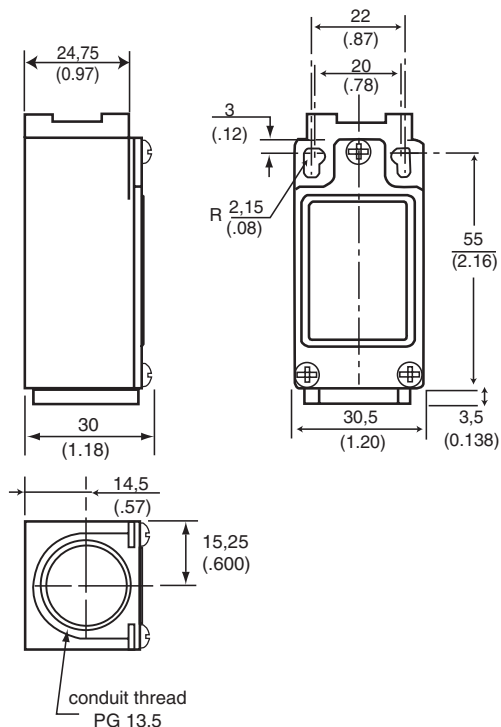

Conduit thread

A = 1/2" NPT

B = PG 13,5

C = 20 mm

Ordering :

GLC **X**

Example : GLC B 01 B

Snap-Action Contacts

1 NORMALLY CLOSED / 1 NORMALLY OPEN

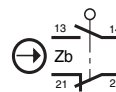

█ Circuit closed
* Positive opening to IEC/EN60947-5-1-3

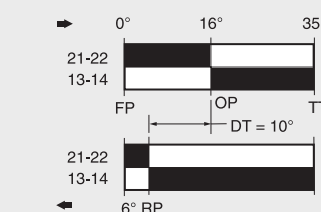
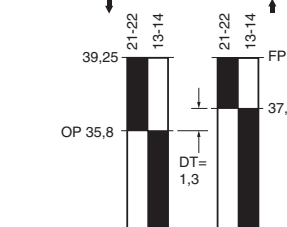
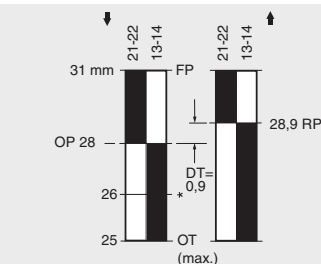
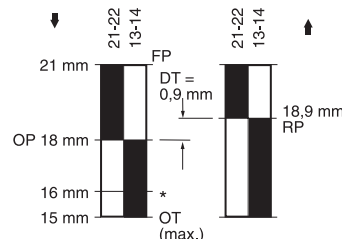
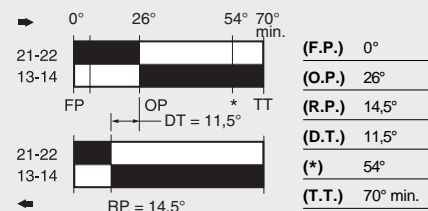

Slow-Action Contacts

BREAK-BEFORE-MAKE

1 NORMALLY CLOSED /
1 NORMALLY OPEN

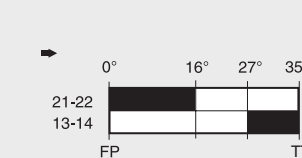
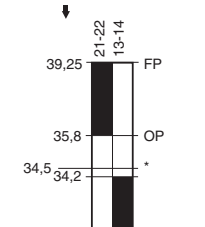
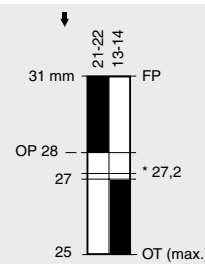
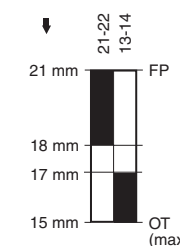
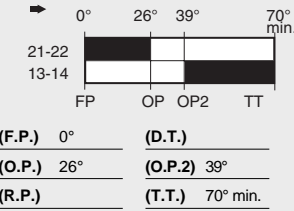
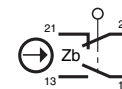

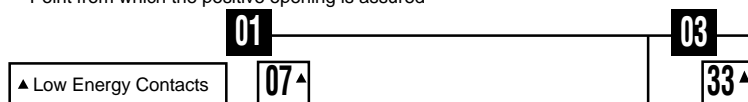

* Point from which the positive opening is assured

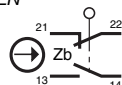
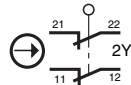
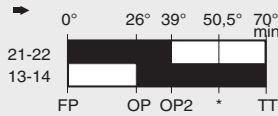
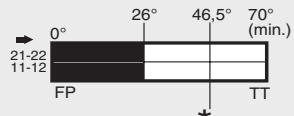
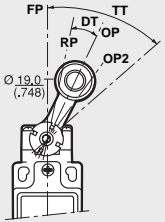
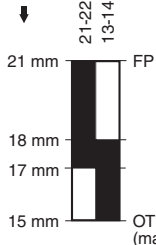
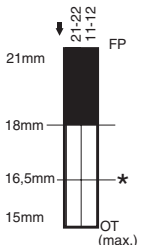
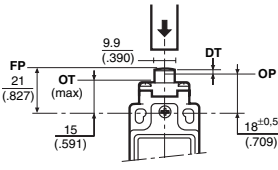
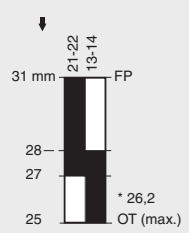
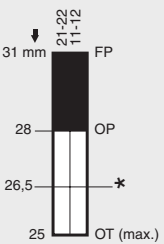
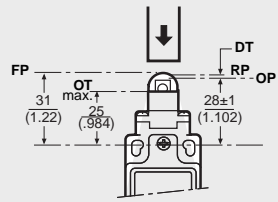
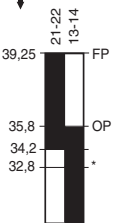
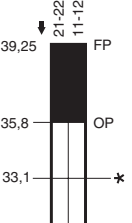
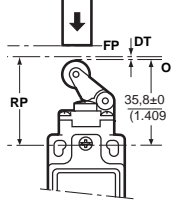

Note: See page 9

XX

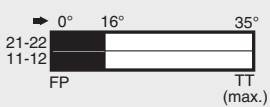
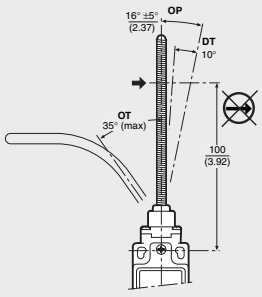
Slow-Action Contacts <i>MAKE BEFORE BREAK</i> 1 NORMALLY CLOSED/ 1 NORMALLY OPEN 	Slow-Action Contacts 2 NORMALLY CLOSED 	Operating torque/force SPDT DPDT		Actuator Types														
 <table border="0"> <tr> <td>(F.P.) 0°</td> <td>(D.T.)</td> </tr> <tr> <td>(O.P.) 26°</td> <td>(O.P.2) 39°</td> </tr> <tr> <td>(R.P.)</td> <td>(T.T.) 70° min.</td> </tr> <tr> <td>(*) 50,5</td> <td></td> </tr> </table>	(F.P.) 0°	(D.T.)	(O.P.) 26°	(O.P.2) 39°	(R.P.)	(T.T.) 70° min.	(*) 50,5		 <table border="0"> <tr> <td>(F.P.) 0°</td> <td>(D.T.)</td> </tr> <tr> <td>(O.P.) 26°</td> <td>(*) 46.5°</td> </tr> <tr> <td>(R.P.)</td> <td>(T.T.) 70° min.</td> </tr> </table>	(F.P.) 0°	(D.T.)	(O.P.) 26°	(*) 46.5°	(R.P.)	(T.T.) 70° min.	0,330 N m (2.90 lb)		 <div style="text-align: right;">A1B</div> <p style="text-align: right;">Additional levers available (see page 23)</p>
(F.P.) 0°	(D.T.)																	
(O.P.) 26°	(O.P.2) 39°																	
(R.P.)	(T.T.) 70° min.																	
(*) 50,5																		
(F.P.) 0°	(D.T.)																	
(O.P.) 26°	(*) 46.5°																	
(R.P.)	(T.T.) 70° min.																	
		16,0 N m (3.60 lb)		 <div style="text-align: right;">B</div> <p style="text-align: center;">Top Pin Plunger</p>														
		16,0 N m (3.60 lb)		 <div style="text-align: right;">C</div> <p style="text-align: center;">Top Roller Plunger</p>														
		9,5 N m (2.10 lb)		 <div style="text-align: right;">D</div> <p style="text-align: center;">Top Roller Lever</p>														
		0,1 N m (0.90 lb)		 <div style="text-align: right;">E7B</div> <p style="text-align: center;">Coil Wobble Stick</p>														

04

34^

06

36^

XXX

GLD EN 50047 Double insulated standard

Technical data

Mechanical life up to 15 million operations

Degree of protection IP66
NEMA/UL type 1, 12, 13

Temperature range Operating : -40°C to +85°C
-40°F to +185°F
Storage : -40°C to +85°C
-40°F to +185°F

Approvals IEC/EN60947-5-1
EN60947-5-1
AC15 A600
DC13 Q300
UL & CSA

Vibration 10 g conforming to IEC 68-2-6
Shock 50-g conforming to IEC 68-2-27
Terminal marking to EN 50013

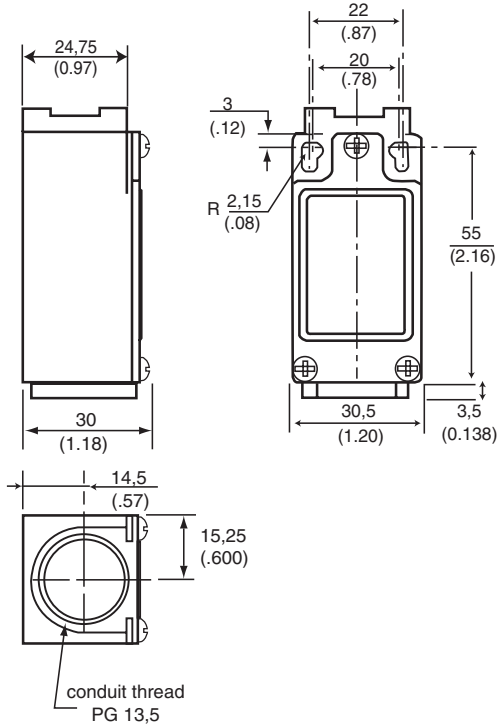

Conduit thread

- A** = 1/2" NPT
- B** = PG 13,5
- C** = 20 mm

Ordering :

GLD **X**

Example : GLD B 01 B

Snap-Action Contacts

1 NORMALLY CLOSED / 1 NORMALLY OPEN

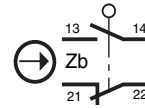

█ Circuit closed
* Positive opening to IEC/EN 60947-5-1-3

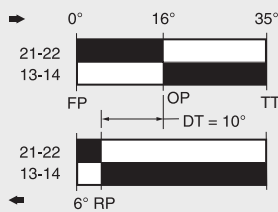
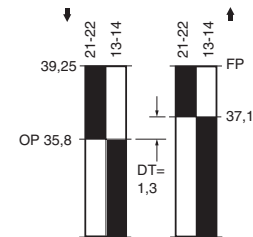
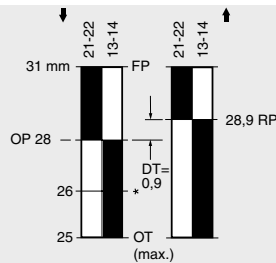
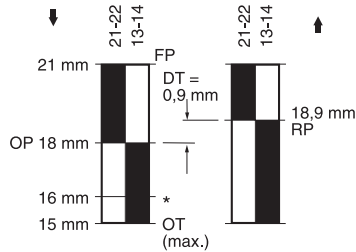
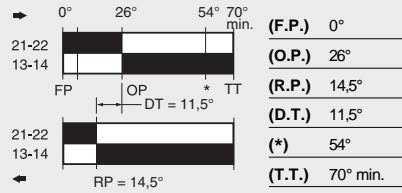

Slow-Action Contacts

BREAK BEFORE MAKE

1 NORMALLY CLOSED /
1 NORMALLY OPEN

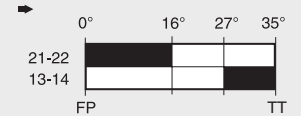
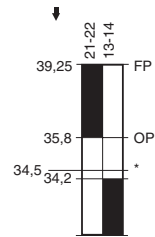
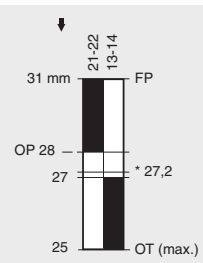
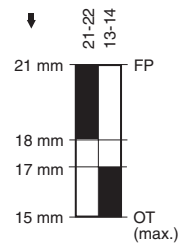
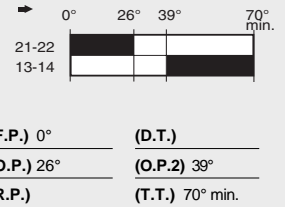
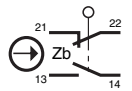

* Point from which the positive opening is assured

01

07▲

▲ Low Energy Contacts

03

33▲

Note: See page 9

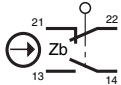
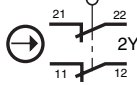
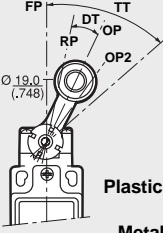
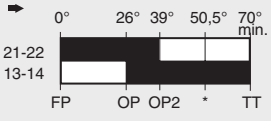
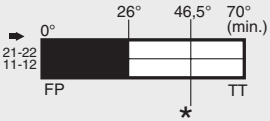
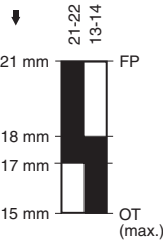
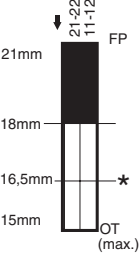
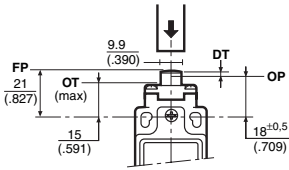
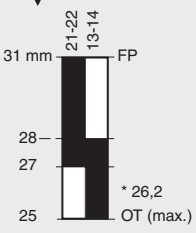
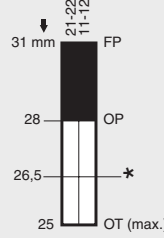
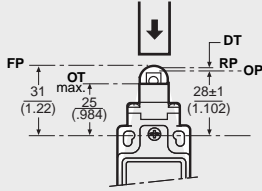
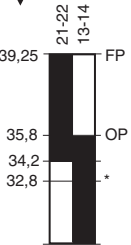
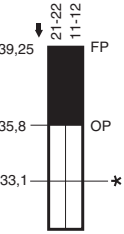
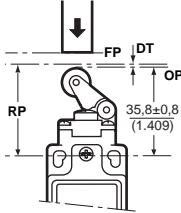
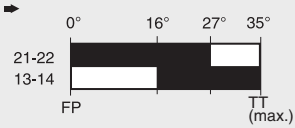
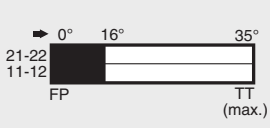
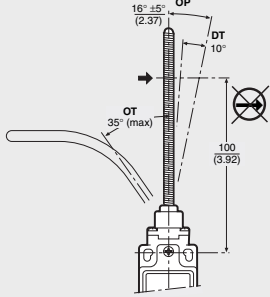
Slow-Action Contacts <i>MAKE BEFORE BREAK</i> 1 NORMALLY CLOSED /	Slow-Action Contacts 2 NORMALLY CLOSED 1 NORMALLY OPEN	Operating torque/force		Actuator Types	
		SPDT	DPDT		
				 <p>Additional levers available (see page 23)</p> <p>Plastic Lever and Roller A1A</p> <p>Metal Lever and Roller A1B</p>	
 <p>(F.P.) 0° (D.T.)</p> <p>(O.P.) 26° (O.P.2) 39°</p> <p>(R.P.) (T.T.) 70° min.</p> <p>(*) 50.5°</p>	 <p>(F.P.) 0° (D.T.)</p> <p>(O.P.) 26° (*) 46.5°</p> <p>(R.P.) (T.T.) 70° min.</p>	0,330 N m (2.90 lb)			
		16,0 N m (3.60 lb)			 <p>Top Pin Plunger</p>
		16,0 N m (3.60 lb)			 <p>Top Roller Plunger</p>
		9,5 N m (2.10 lb)			 <p>Top Roller Lever</p>
		0,1 N m (0.90 lb)		 <p>Coil Wobble Stick</p>	

04

34^A

06

36^A

XX

XXX

GLE EN 50047 Compatible 3 conduit metal standard

Technical data

Mechanical life	up to 15 million operations
Degree of protection	IP 67 (wobble: IP 66) NEMA/UL type 1, 4, 12, 13
Temperature range	Operating: -40°C to +85°C -40°F to +185°F Storage: -40°C to +85°C -40°F to +185°F
Approvals	IEC60947-5-1 EN60947-5-1 AC15 A300 DC13 Q300 UL & CSA
Vibration	10 g conforming to IEC 68-2-6
Shock	50 g conforming to IEC 68-2-27 Terminal marking to EN 50013

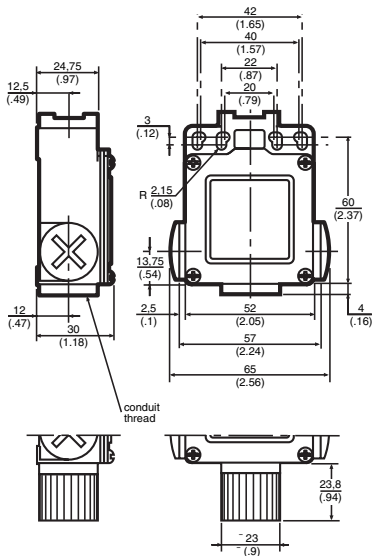

Conduit thread

- A** = 1/2" NPT adaptor
- B** = PG 13,5
- C** = 20 mm

Ordering :

GLE **X**

Example : GLE B 01 B

Snap-Action Contacts

1 NORMALLY CLOSED /
1 NORMALLY OPEN

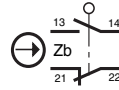

■ Circuit closed
* Positive opening to IEC/EN60947-5-1-3

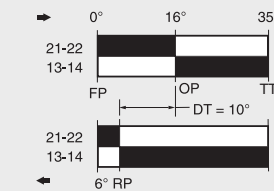
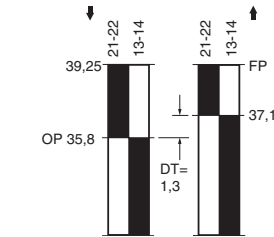
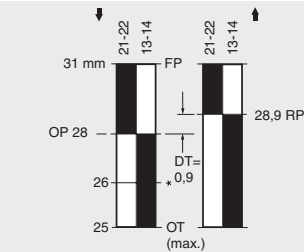
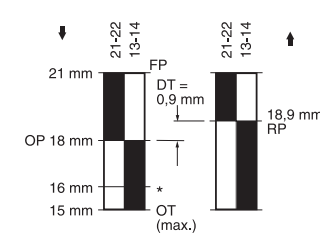
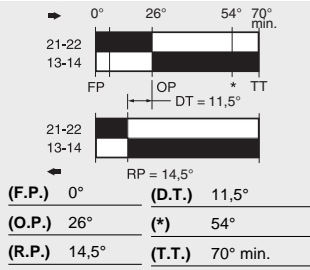

Slow-Action Contacts

BREAK BEFORE MAKE
1 NORMALLY CLOSED /
1 NORMALLY OPEN

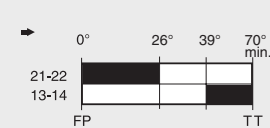
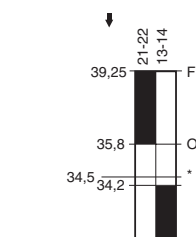
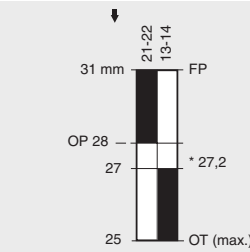
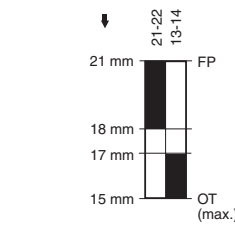
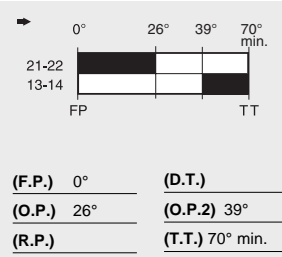
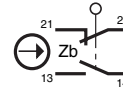

Slow-Action Contacts

MAKE BEFORE BREAK
1 NORMALLY CLOSED /

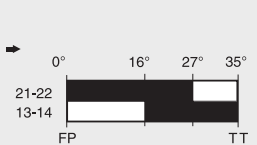
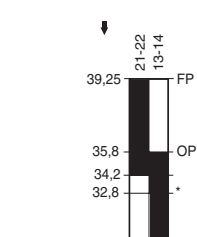
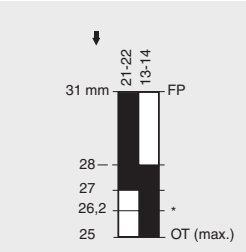
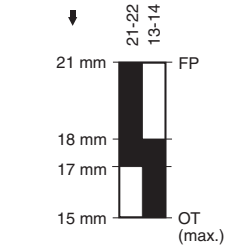
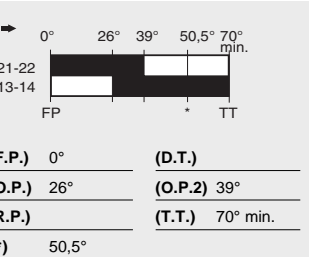
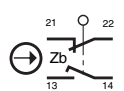

* Point from which the positive opening is assured

01

07[▲]

▲ Low Energy Contacts

Note: See page 9

03

33[▲]

04

34[▲]

XX

Slow-Action Contacts

2 NORMALLY CLOSED

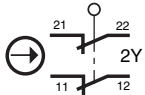

Snap-Action Contacts

DOUBLE POLE

2 NORMALLY CLOSED/
2 NORMALLY OPEN

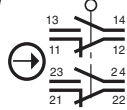

Operating torque/force

SPDT

DPDT

Actuator Types

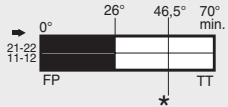

(F.P.) 0°	(D.T.)
(O.P.) 26°	(*) 46.5°
(R.P.)	(T.T.) 70° min.

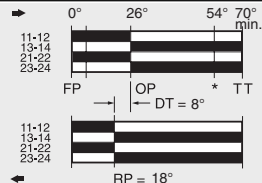

(F.P.) 0°	(D.T.) 8°
(O.P.) 26°	(*) 54°
(R.P.) 18°	(T.T.) 70° min.

0,330 N m
(2.90 lb)

0,120 N m
(1.10 lb)

0,165 N m
(1.50 lb)
GLE only

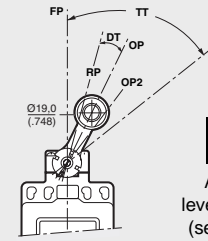

A1B

Additional levers available (see page 23)

Side Rotary, Metal Roller

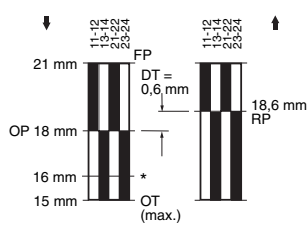
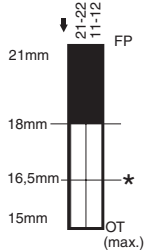

16,0 N m
(3.60 lb)

16,0 N m
(3.60 lb)

13,0 N m
(2.90 lb)
GLE only

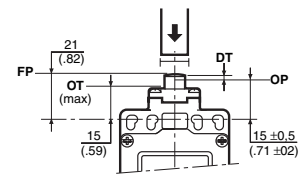

Top Pin Plunger

B

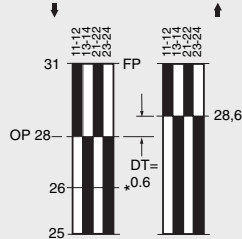
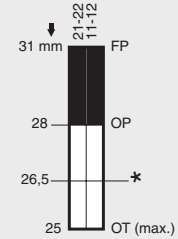

16,0 N m
(3.60 lb)

16,0 N m
(3.60 lb)

13,0 N m
(2.90 lb)
GLE only

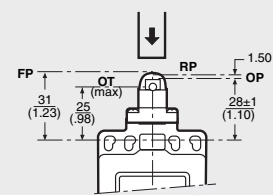

Top Roller Plunger

C

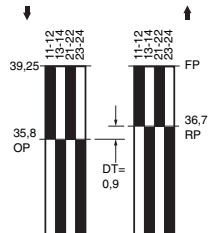
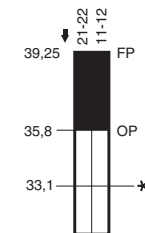

9,5 N m
(2.10 lb)

11,0 N m
(2.4 lb)

9,0 N m
(1.9 lb)
GLE only

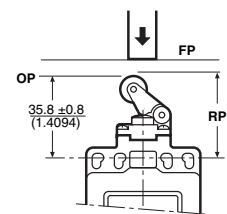

Top Roller Lever

D

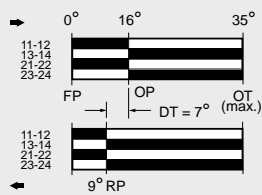
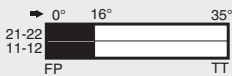

0,1 N m
(0.90 lb)

1,3 N m
(0.29 lb)

1,1 N m
(0.25 lb)
GLE only

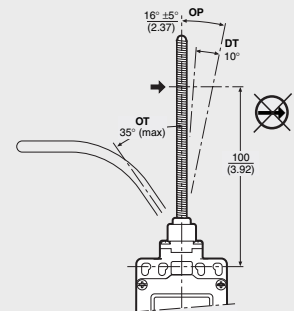

Coil Wobble Stick

E7B

06

24

36^Δ

32^Δ

XXX

Additional lever types

For use with all Side Rotary Head Styles.

Figure 1 illustrates Miniature product lever types conforming to EN 50047 while

Figure 2

illustrates Standard product lever types which conform to EN 50041. All dimensions are in mm/(inches).

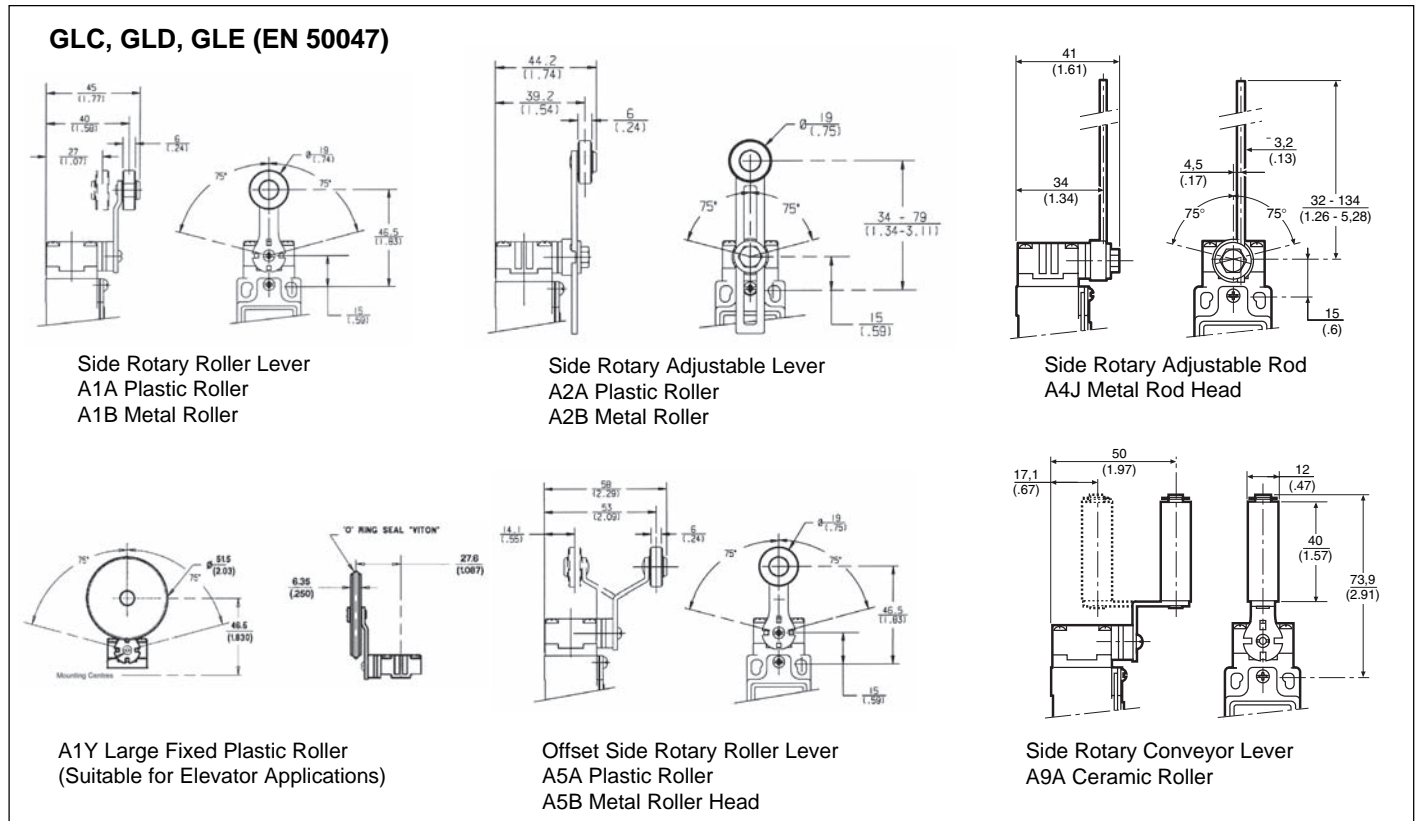

Replacement Parts - Basic switches

Body Type	Basic Switch								
	01	02	03	04	06	12	13	20	24
GLC	GLZ301		GLZ303	GLZ304	GLZ306				
GLD	GLZ301		GLZ303	GLZ304	GLZ306				
GLE	GLZ301		GLZ303	GLZ304	GLZ306				GLZ324

This publication does not constitute a contract between Honeywell and its customers. The contents may be changed at any time without notice. It is the customer's responsibility to ensure safe installation and operation of the products. Detailed mounting drawings of all products illustrated are available on request. © 2004 Honeywell International Inc. All rights reserved.

Honeywell

Honeywell
11 West Spring Street
Freeport, Illinois 61032
USA