

MINIATURE

D4 Series

Features

- 8 current ratings
- Choice of actuators
- Various terminal types
- 3 contact arrangements
- Choice of standard or light operating force
- Long-life coil spring mechanism
- Agency approved extended life versions
- ENEC/VDE approval standard on European versions
- Stackable case and cover available upon request

European Approved Versions

D4 series switches with metric mounting holes automatically carry ENEC approval. D4 series switches with U.S. mounting holes have optional VDE approval. Contact factory for part number. Switches with straight terminals may require insulated connectors for international approval.

Electrical Ratings

Switch Series	EN61058 Rating	UL1054 Rating	Electrical Life at Rated Load	
			According to EN (Min. Operations)	According to UL (Min. Operations)
D40	N/A	1.0A, 125VAC	NA	6,000*
D41	0.1(0.05)A, 250V~	0.1A, 125/250VAC	50,000	6,000*
D42	3(1)A, 250V~	3A, 125/250VAC; 1/10HP, 250VAC	50,000	6,000*
D43	6(2)A, 250V~	5A, 1/4HP, 125/250VAC	50,000	6,000*
D44	10(3)A, 250V~	10A, 1/2HP, 125/250VAC	50,000	6,000*
D45	16(4)A, 250V~ 10(3)A, 400V~ (Std. force only)	15A, 1/2HP, 125/250VAC	50,000	6,000*
D48	21(8)A, 250V~	21A, 1HP, 125VAC; 2HP, 250VAC	10,000	6,000
D49	N/A	10A, 1/2HP, 125/250VAC; 6A, 30VDC	NA	6,000*

Operating life for 125°C and 150°C available upon request.

*Indicates 100K life available. Consult factory.

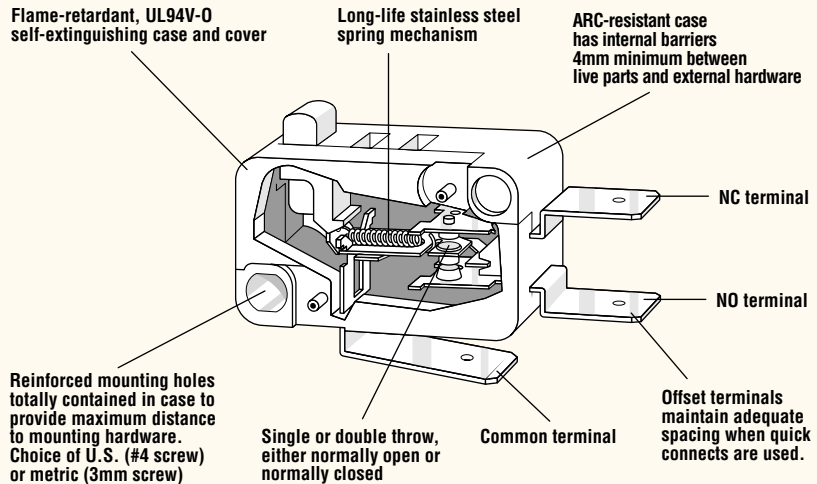

Specifications

Electrical

Temperature Rating: -40° to +85°C, 125°C or 150°C

Flammability Rating: UL94V-0

Materials

Case: Thermoplastic Polyester (PBT), European Versions (PET)

Actuating Button: Thermoplastic Acetal (POM), 85°C
Thermoplastic Polyester (PET), 125°C or 150°C

Auxiliary Actuator: Aluminum, Stainless Steel or Cold-Rolled Steel (Nickel-Plated)

Common Terminal: Silver-Plated Brass

NO/NC Terminals: Brass (D40, D41, D42, D43, D44, D49)
Brass (D45, European versions)
Copper (D45, US Versions)
Silver-Plated Copper (D48, US versions)
Copper (D48, European versions)

Moving Blade: Brass (D40, D41, D42, D43)
Beryllium Copper (D44, D45, D48)

Contacts: Gold Crosspoint (D40, D41)
Silver Alloy (D42, D43, D44, D45, D48, D49)



Dimensions

European Version (mm)

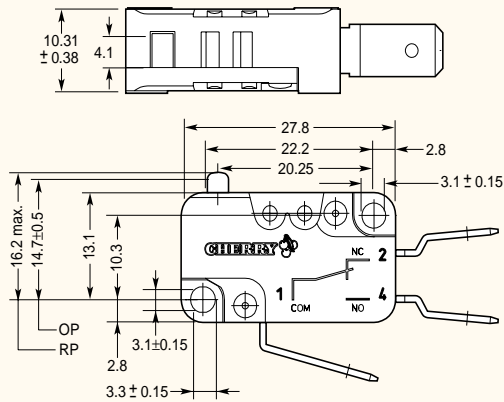

U.S. Version (inches)



Terminals

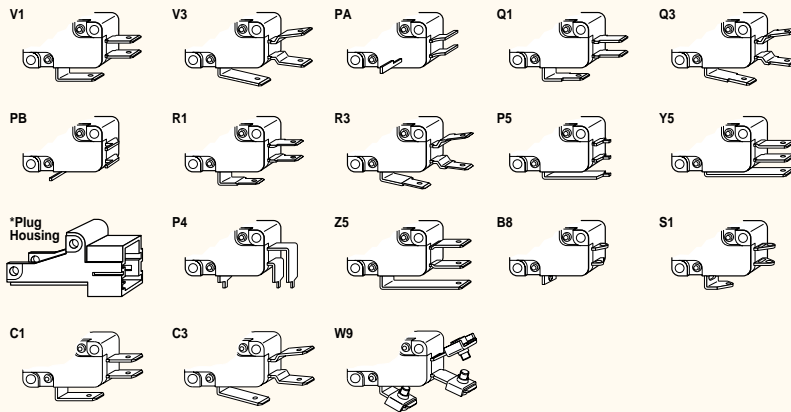

*Connector Part #623-0518 (mates with Y5 only).

Drilling Patterns for PCB Terminals

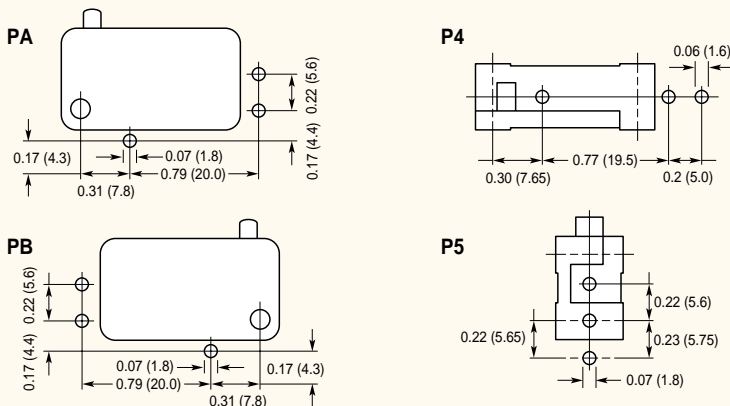

Actuators

Many special forms and lengths of actuators are available. Standard type integral hinged lever and roller actuators are available in choice of 2 mounting positions. Actuation lengths are dimensioned from centerline of switch mounting hole as shown.

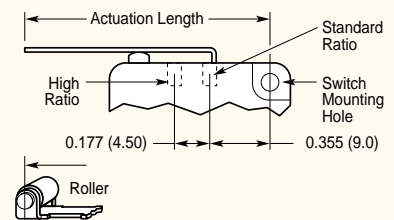

EN (VDE) Identifiers

Switches with a "standard" operating force are identified by a 'Y' next to the standard model description, e.g. D43Y.

Switches with a "light" operating force are identified by an 'X' next to the standard model description, e.g. D43X.

Mounting — US Version

Recommended mounting screw size: #4-40 Round head. Recommended torque on screw: 3 inch lbs. max.

Mounting — European Version

Recommended mounting screw size: M3. Recommended torque on screw: 70N cm max.

Actuator Specifications — US Versions

Actuator Type	Switch Type	Maximum Operating Force (Gms.)							Maximum Pre-Travel inches (mm)		Operating Point inches (mm)		Minimum Over Travel inches (mm)		Max. Movement Differential inches (mm)		Actuation Length inches (mm)		
		D40, D41, D42		D43	D44		D45	D48		D49	D40-D45, D49		D48		D40-D45, D49		D48		
		Std / Light	Std / Light	Std / Light	Std / Light	Std / Light	Std / Light	Std / Light	Std / Light	D40-D45, D49	D48	D40-D45, D49	D48	D40-D45, D49	D48	D40-D45, D49	D48		
AA		75 / 15	170 / 45	285 / 75	400 / 100	— / 120	285 / 75	0.047 (1.19)	0.070 (1.78)	0.558/0.598 (14.17/15.19)	0.537/0.557 (13.64/14.15)	0.050 (1.27)	0.040 (1.02)	0.010 (0.25)	0.010 (0.25)	—			
LA		75 / 15	170 / 45	285 / 75	400 / 100	— / 183	285 / 75	0.062 (1.57)	0.063 (1.60)	0.580/0.620 (14.73/15.75)	0.578/0.618 (14.70/15.70)	0.050 (1.27)	0.031 (0.80)	0.016 (0.41)	0.011 (0.30)	0.865 (21.97)			
LD**†		35 / 8	86 / 23	144 / 37	200 / 51	— / 77	144 / 37	0.125 (3.18)	0.150 (3.80)	0.555/0.645 (14.10/16.38)	0.563/0.657 (14.0/16.4)	0.085 (2.16)	0.071 (1.80)	0.030 (0.76)	0.031 (0.80)	1.40 (35.56)			
MD**††		20 / 5	51 / 14	86 / 23	120 / 30	— / 46	86 / 30	0.222 (5.59)	0.252 (6.40)	0.525/0.675 (13.6/18.8)	0.535/0.661 (13.6/16.8)	0.130 (3.30)	0.126 (3.20)	0.050 (1.27)	0.051 (1.30)	1.580 (40.13)			
JL***†††		17 / 3.5	38 / 10	63 / 17	90 / 22	— / 36	63 / 17	0.300 (7.62)	0.347 (8.80)	0.500/0.700 (12.70/17.78)	0.472/0.724 (12.0/18.4)	0.187 (4.75)	0.169 (4.30)	0.065 (1.65)	0.067 (1.70)	2.757 (70.03)			
RA		75 / 15	170 / 45	285 / 75	400 / 100	— / —	285 / 75	0.047 (1.19)	—	0.776/0.836 (19.71/21.33)	—	0.040 (1.02)	—	0.010 (0.25)	—	0.810 (20.57)			
RD		35 / 8	86 / 22	144 / 37	200 / 50	— / —	144 / 37	0.125 (3.18)	—	0.761/0.851 (19.33/21.62)	—	0.085 (2.16)	—	0.030 (0.76)	—	1.240 (34.04)			
TD		25 / 5	51 / 14	86 / 22	120 / 30	— / —	86 / 22	0.200 (5.08)	—	0.731/0.881 (18.57/22.38)	—	0.120 (3.05)	—	0.040 (1.02)	—	1.512 (38.51)			
GD		35 / 8	86 / 33	144 / 47	200 / 50	— / —	144 / 37	0.125 (3.18)	—	1.000/1.090 (25.40/27.69)	—	0.085 (2.16)	—	0.030 (0.76)	—	1.340 (34.04)			

*Auxiliary levers on light force D40, D41 and D42 will be made out of Aluminum.

†YD suffix for D40, D41 and D42. ††XD suffix for D40, D41 and D42. †††YL suffix for D40, D41 and D42.

Ordering Information — US Versions

D4		3	
Series/Prefix			
Code	EN61058	UL1054	
0	N/A	1.0A, 125VAC	
1	0.1(0.5)A, 250V	0.1A, 125/250VAC	
2	3(1)A, 250V	3A, 125/250VAC 1/10HP, 250VAC	
3	6(2)A, 250V	5A, 1/4HP, 125/250VAC	
4	10(3)A, 250V	10A, 1/2HP, 125/250VAC	
5	16(4)A, 250V 10(3)A, 400V~ (Std. force only)	15A, 1/2HP, 125/250VAC	
8	21(8)A, 250V	21A, 1HP, 125VAC 2HP, 250VAC	
9	N/A	10A, 1/2HP, 125/250VAC 6A, 30VDC	

VDE optional for D41–D44 with U.S. mounting holes.

Mounting Holes	3			Oper. Force	Temp. Index
	NO	NC	DT		
	A	B	C		
	J	K	L		
US Mounting Holes (VDE Optional)	D	E	F	Std.	85°C
	W	X	Y	Light	150°C*

*D45 and D48 with VDE only available with metric holes. See European ordering information.

Code	Terminal Type	inches (mm)
Q1	0.187 x 0.032 (4.8 x 0.8) QC	Straight*
Q3	0.187 x 0.032 (4.8 x 0.8) QC	Dog Leg*
R1	0.187 x 0.020 (4.8 x 0.8) QC	Straight*
V1	0.250 x 0.032 (6.3 x 0.8) QC	Straight
V3	0.250 x 0.032 (6.3 x 0.8) QC	Dog Leg

*Not available for D48.

L		D		
Code	Actuator Type	Code		
		A	D	L
Actuation Length inches (mm)				
AA	Button	—	—	—
L	Lever SR	0.865 (21.97)	1.400 (35.56)	2.757 (70.02)
M	Lever HR	1.042 (26.47)	1.580 (40.13)	2.934 (74.52)
Y	Alum. Lever SR	—	1.400 (35.56)	2.757 (70.03)
X	Alum. Lever HR	—	1.580 (40.13)	2.932 (74.47)
J	SS Lever SR	—	—	2.757 (70.03)
K	SS Lever HR	—	—	2.932 (74.47)
R	Roller SR	0.810 (20.57)	1.340 (34.04)	—
T	Roller HR	0.987 (25.07)	1.516 (38.51)	—
G	1-Way Roller SR	0.810 (20.57)	1.340 (34.04)	—
N	1-Way Roller HR	0.987 (25.07)	1.516 (38.51)	—

SR = Standard Ratio, Back Hole • HR = High Ratio, Front Hole
Additional actuators available upon request.

Actuator Specifications — European Versions

Actuator Type	Switch Type	Maximum Operating Force (Gms.)						Maximum Pre-Travel inches (mm)		Operating Point inches (mm)	Minimum Over Travel inches (mm)		Max. Movement Differential inches (mm)		Max. Rest Position inches (mm)		Actuation Length inches (mm)
		D41, D42 Std / Light	D43 Std / Light	D44 Std / Light	D45 Std / Light	D48	D41-D45	D48	D41-D45		D48	D41-D45	D48	D41-D45	D48		
AA		75 / 15	170 / 45	285 / 75	400 / 100	150	0.047 (1.2)	0.063 (1.6)	0.543/0.598 (13.8/15.2)	0.051 (1.3)	0.047 (1.2)	0.012 (0.3)	0.012 (0.3)	0.638 (16.2)	0.638 (16.2)	—	
MA/KA		50 / 10	110 / 28	180 / 50	256 / 65	100	0.087 (2.2)	0.118 (3.0)	0.567/0.630 (14.4/16.0)	0.063 (1.6)	0.055 (1.4)	0.024 (0.6)	0.024 (0.6)	0.740 (18.8)	0.740 (18.8)	1.01 (25.7)	
LA/JA*		85 / 17	190 / 50	320 / 85	440 / 115	180	0.047 (1.2)	0.063 (1.6)	0.579/0.618 (14.7/15.7)	0.035 (0.9)	0.031 (0.8)	0.012 (0.3)	0.012 (0.3)	0.661 (16.8)	0.661 (16.8)	0.835 (21.2)	
JD/LD*		40 / 8	86 / 22	144 / 40	200 / 50	75	0.126 (3.2)	0.150 (3.8)	0.551/0.646 (14.0/16.4)	0.091 (2.3)	0.071 (1.8)	0.031 (0.8)	0.031 (0.8)	0.780 (19.8)	0.780 (19.8)	1.40 (35.6)	
KD/MD*		25 / 5	50 / 14	86 / 25	120 / 30	45	0.200 (5.1)	0.252 (6.4)	0.535/0.661 (13.6/16.8)	0.142 (3.6)	0.126 (3.2)	0.051 (1.3)	0.051 (1.3)	0.874 (22.2)	0.874 (22.2)	1.58 (40.1)	
LL/JL*		17 / 3.5	40 / 10	60 / 17	90 / 22	35	0.299 (7.6)	0.346 (8.8)	0.465/0.724 (11.8/18.4)	0.185 (4.7)	0.169 (4.3)	0.067 (1.7)	0.067 (1.7)	0.992 (25.2)	0.992 (25.2)	2.75 (69.9)	
ML/KL*		10 / 2	25 / 6	40 / 10	56 / 13	20	0.500 (12.7)	0.575 (14.6)	0.433/0.764 (11.0/19.4)	0.031 (7.9)	0.283 (7.2)	0.098 (2.5)	0.098 (2.5)	1.210 (30.8)	1.210 (30.8)	2.93 (74.4)	
RA		90 / 15	190 / 45	330 / 75	440 / 100	180	0.047 (1.2)	0.067 (1.7)	0.776/0.839 (19.7/21.3)	0.039 (1.0)	0.031 (0.8)	0.016 (0.4)	0.012 (0.3)	0.858 (21.8)	0.866 (22.0)	0.811 (20.6)	
RD		40 / 8	86 / 22	144 / 40	200 / 50	75	0.126 (3.2)	0.150 (3.8)	0.764/0.850 (19.4/21.6)	0.087 (2.2)	0.071 (1.8)	0.031 (0.8)	0.031 (0.8)	0.976 (24.8)	0.976 (24.8)	1.34 (34.1)	
TD		25 / 14	55 / 14	86 / 22	120 / 30	50	0.200 (5.1)	0.244 (6.2)	0.744/0.870 (18.9/22.1)	0.142 (3.6)	0.118 (3.0)	0.051 (1.3)	0.047 (1.2)	1.080 (27.4)	1.078 (27.4)	1.52 (38.6)	
TA		55 / 10	110 / 30	200 / 55	260 / 70	110	0.087 (2.2)	0.118 (3.0)	0.764/0.850 (19.4/21.6)	0.063 (1.6)	0.051 (1.3)	0.024 (0.6)	0.024 (0.6)	0.937 (23.8)	0.945 (24.0)	0.988 (25.1)	
UA		55 / 11	120 / 32	215 / 55	280 / 70	110	0.087 (2.2)	0.118 (3.0)	0.768/0.846 (19.5/21.5)	0.063 (1.6)	0.051 (1.3)	0.020 (0.5)	0.020 (0.5)	0.937 (23.8)	0.945 (24.0)	0.988 (25.1)	
SA		85 / 17	190 / 50	330 / 85	440 / 115	200	0.051 (1.3)	0.067 (1.7)	0.780/0.835 (19.8/21.2)	0.039 (1.0)	0.031 (0.8)	0.012 (0.3)	0.012 (0.3)	0.858 (21.8)	0.866 (22.0)	0.811 (20.6)	

*On light force D41 and D42, auxiliary actuators MD, ML, LD and LL are made out of Aluminum.

Ordering Information — European Versions

D4 **3**

Series/Prefix

Code	EN61058	UL1054
1	0.1(0.5)A, 250V	0.1A, 125/250VAC
2	3(1)A, 250V	3A, 125/250VAC 1/10HP, 250VAC
3	6(2)A, 250V	5A, 1/4HP, 125/250VAC
4	10(3)A, 250V	10A, 1/2HP, 125/250VAC
5	16(4)A, 250V 10(3)A, 400V~ (Std. force only)	15A, 1/2HP, 125/250VAC
8	21(8)A, 250V	21A, 1HP, 125VAC 2HP, 250VAC
9	N/A	10A, 1/2HP, 125/250VAC 6A, 30VDC

EN standard on all D4 European designs.

3 **V3**

Mounting Holes	NO			NC			DT			Oper. Force	Temp. Index
	1	2	3	1	2	3	1	2	3		
	European Metric Mounting Holes (EN Standard)	7	8	9	Light			85°C			
		G	H	M	Std.			125°C			
		N	P	R	Light			150°C			
S		T	U	Light			150°C				

L **D**

Code	Actuator Type	Code			Actuation Length inches (mm)		
		A	D	L	A	D	L
AA	Button	—	—	—	—	—	—
J	SS Lever SR	0.835 (21.2)	1.4 (35.6)	2.75 (69.9)	—	—	—
K	SS Lever HR	1.01 (25.7)	—	2.93 (74.4)	—	—	—
L	Lever SR	0.835 (21.2)	1.4 (35.6)	2.75 (69.9)	—	—	—
M	Lever HR	1.01 (25.7)	—	2.93 (74.4)	—	—	—
R	Roller SR	0.811 (20.6)	1.34 (34.1)	—	—	—	—
S	Sim. Roller SR	0.811 (20.6)	—	—	—	—	—
T	Roller HR	0.988 (25.1)	1.52 (38.6)	—	—	—	—
U	Sim. Roller HR	0.988 (25.1)	—	—	—	—	—

SR = Standard Ratio, Back Hole • HR = High Ratio, Front Hole
Additional actuators available upon request.

Code	Terminal Type	inches (mm)
A1	Welding	
B8	Short Solder*	
C1	0.110 x 0.032 (2.8 x 0.8) QC, Bifurcated Straight**	
C3	0.110 x 0.032 (2.8 x 0.8) QC, Bifurcated Dog Leg**	
P4	0.047 x 0.020 (1.2 x 0.5) PCB, Underside*	
P5	0.047 x 0.020 (1.2 x 0.5) PCB, Rear*	
PA	0.047 x 0.032 (1.2 x 0.8) PCB, Housing Side*	
PB	0.047 x 0.032 (1.2 x 0.8) PCB, Cover Side*	
Q1	0.187 x 0.032 (4.8 x 0.8) QC Straight*	
Q3	0.187 x 0.032 (4.8 x 0.8) QC Dog Leg*	
R1	0.187 x 0.020 (4.8 x 0.8) QC, Straight**	
R3	0.187 x 0.020 (4.8 x 0.5) QC, Dog Leg**	
S1	Solder with Temp. Stop	
V1	0.250 x 0.032 (6.3 x 0.8) QC, Straight	
V3	0.250 x 0.032 (6.3 x 0.8) QC, Dog Leg	
W9	Screw*	
Y5	0.250 x 0.032 (6.3 x 0.8) QC, 5mm Grid	
Z5	0.250 x 0.032 (6.3 x 0.8) QC, 7mm Grid	

* Not available for D48 European versions.
** Not available for D45 or D48 versions.