



VNN7NV04, VNS7NV04 VND7NV04, VND7NV04-1

OMNIFET II fully autoprotected Power MOSFET

Features

Type	$R_{DS(on)}$	I_{lim}	V_{clamp}
VNN7NV04 VNS7NV04 VND7NV04 VND7NV04-1	60 m Ω	6 A	40 V

- Linear current limitation
- Thermal shutdown
- Short circuit protection
- Integrated clamp
- Low current drawn from input pin
- Diagnostic feedback through input pin
- ESD protection
- Direct access to the gate of the Power MOSFET (analog driving)
- Compatible with standard Power MOSFET in compliance with the 2002/95/EC European Directive

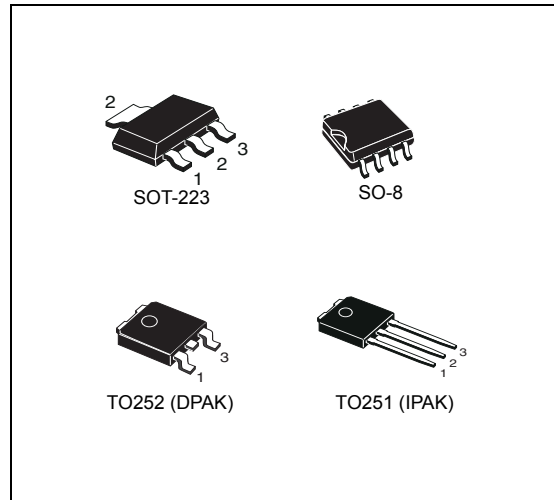

Description

The VNN7NV04, VNS7NV04, VND7NV04, VND7NV04-1, are monolithic devices designed in STMicroelectronics VIPower M0-3 Technology, intended for replacement of standard Power MOSFETs from DC up to 50 kHz applications. Built in thermal shutdown, linear current limitation and overvoltage clamp protect the chip in harsh environments.

Fault feedback can be detected by monitoring the voltage at the input pin.

Table 1. Device summary

Package	Order codes			
	Tube	Tube (lead-free)	Tape and reel	Tape and reel (lead-free)
SOT-223	VNN7NV04	-	VNN7NV0413TR	-
SO-8	VNS7NV04	-	VNS7NV0413TR	-
TO-252	VND7NV04	VND7NV04-E	VND7NV0413TR	VND7NV04TR-E
TO-251	VND7NV04-1	VND7NV04-1-E	-	-

Contents

1	Block diagram and pin description	6
2	Electrical specifications	7
2.1	Absolute maximum ratings	7
2.2	Thermal data	8
2.3	Electrical characteristics	8
3	Protection features	10
3.1	Electrical characteristics curves	13
3.2	SO-8 maximum demagnetization energy	17
3.3	DPAK maximum demagnetization energy	18
3.4	SOT-223 maximum demagnetization energy	19
4	Package and PCB thermal data	20
4.1	SO-8 thermal data	20
4.2	SOT-223 thermal data	22
4.3	DPAK thermal data	24
5	Package and packing information	27
5.1	TO-251 (IPAK) mechanical data	27
5.2	TO-252 (DPAK) mechanical data	28
5.3	SOT-223 mechanical data	29
5.4	SO-8 mechanical data	30
5.5	SOT-223 packing information	32
5.6	SO-8 packing information	33
5.7	DPAK packing information	34
5.8	IPAK packing information	35
6	Revision history	36

List of tables

Table 1.	Device summary	1
Table 2.	Absolute maximum ratings	7
Table 3.	Thermal data.	8
Table 4.	Electrical characteristics	8
Table 5.	SO-8 thermal parameter	21
Table 6.	SOT-223 thermal parameter	23
Table 7.	DPAK thermal parameter	25
Table 8.	TO-251 (IPAK) mechanical data	27
Table 9.	TO-252 (DPAK) mechanical data	28
Table 10.	SOT-223 mechanical data	29
Table 11.	SO-8 mechanical data	30
Table 12.	Document revision history	36

List of figures

Figure 1.	Block diagram	6
Figure 2.	Configuration diagram (top view)	6
Figure 3.	Current and voltage conventions	7
Figure 4.	Switching time test circuit for resistive load	11
Figure 5.	Test circuit for diode recovery times	11
Figure 6.	Unclamped inductive load test circuits	12
Figure 7.	Input charge test circuit.	12
Figure 8.	Unclamped inductive waveforms	12
Figure 9.	Derating curve	13
Figure 10.	Transconductance	13
Figure 11.	Static drain-source on resistance vs input voltage (part 1/2)	13
Figure 12.	Static drain-source on resistance vs input voltage (part 2/2)	13
Figure 13.	Source-drain diode forward characteristics	13
Figure 14.	Static drain source on resistance	13
Figure 15.	Turn-on current slope (part 1/2)	14
Figure 16.	Turn-on current slope (part 2/2)	14
Figure 17.	Transfer characteristics	14
Figure 18.	Static drain-source on resistance vs I_d	14
Figure 19.	Input voltage vs input charge	14
Figure 20.	Turn-off drain source voltage slope (part 1/2).	14
Figure 21.	Turn-off drain source voltage slope (part 2/2).	15
Figure 22.	Capacitance variations	15
Figure 23.	Output characteristics	15
Figure 24.	Normalized on resistance vs temperature	15
Figure 25.	Switching time resistive load (part 1/2)	15
Figure 26.	Switching time resistive load (part 2/2)	15
Figure 27.	Normalized input threshold voltage vs temperature	16
Figure 28.	Normalized current limit vs junction temperature	16
Figure 29.	Step response current limit	16
Figure 30.	SO-8 maximum turn-off current versus load inductance.	17
Figure 31.	SO-8 demagnetization	17
Figure 32.	DPAK maximum turn-off current versus load inductance	18
Figure 33.	DPAK demagnetization.	18
Figure 34.	SOT-223 maximum turn-off current versus load inductance	19
Figure 35.	SOT-223 demagnetization	19
Figure 36.	SO-8 PC board	20
Figure 37.	Rthj-amb vs PCB copper area in open box free air condition.	20
Figure 38.	SO-8 thermal impedance junction ambient single pulse.	21
Figure 39.	Thermal fitting model of an OMNIFET II in SO-8	21
Figure 40.	SOT-223 PC board	22
Figure 41.	Rthj-amb vs PCB copper area in open box free air condition.	22
Figure 42.	SOT-223 thermal impedance junction ambient single pulse.	23
Figure 43.	Thermal fitting model of an OMNIFET II in SOT-223	23
Figure 44.	DPAK PC board	24
Figure 45.	Rthj-amb vs PCB copper area in open box free air condition.	24
Figure 46.	DPAK thermal impedance junction ambient single pulse	25
Figure 47.	Thermal fitting model of an OMNIFET II in DPAK.	25
Figure 48.	TO-251 (IPAK) package dimensions	28

Figure 49.	TO-252 (DPAK) package dimensions	29
Figure 50.	SOT-223 package dimensions	30
Figure 51.	SO-8 package dimensions	31
Figure 52.	SOT-223 tape and reel shipment (suffix "TR")	32
Figure 53.	SO-8 tube shipment (no suffix)	33
Figure 54.	SO-8 tape and reel shipment (suffix "TR")	33
Figure 55.	DPAK footprint and tube shipment (no suffix)	34
Figure 56.	DPAK tape and reel shipment (suffix "TR")	34
Figure 57.	IPAK tube shipment (no suffix)	35

1 Block diagram and pin description

Figure 1. Block diagram

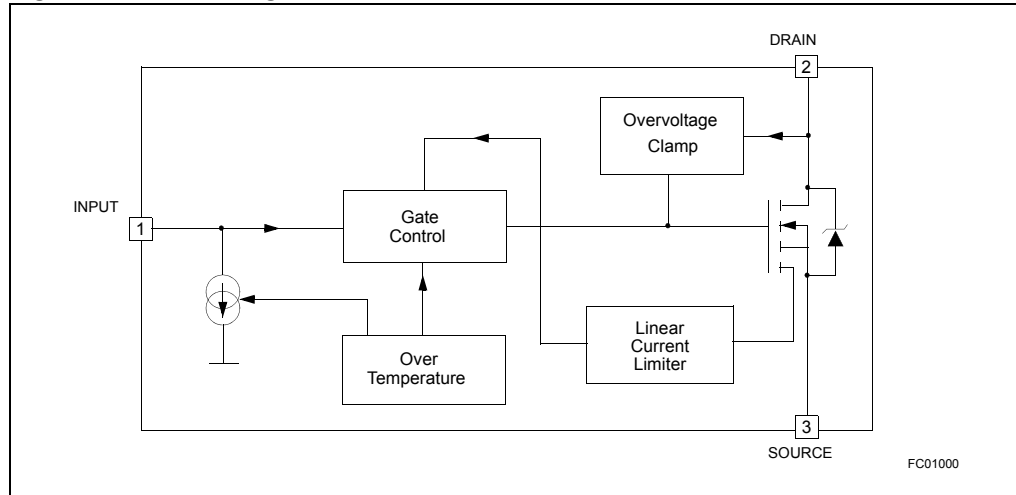
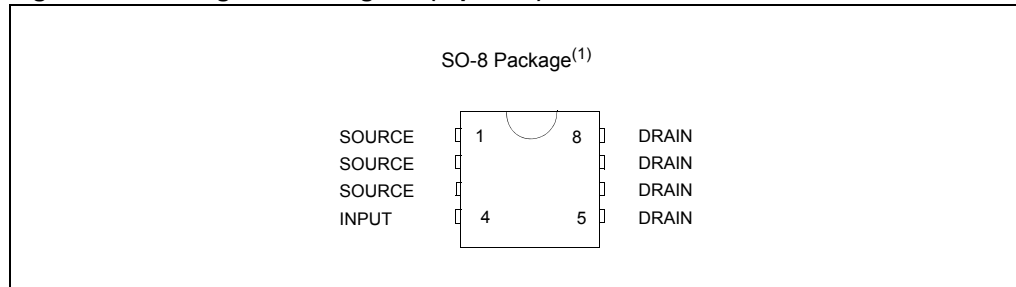

Figure 2. Configuration diagram (top view)



1. For the pins configuration related to SOT-223, DPAK, IPAK see outlines at page 1.

2 Electrical specifications

Figure 3. Current and voltage conventions

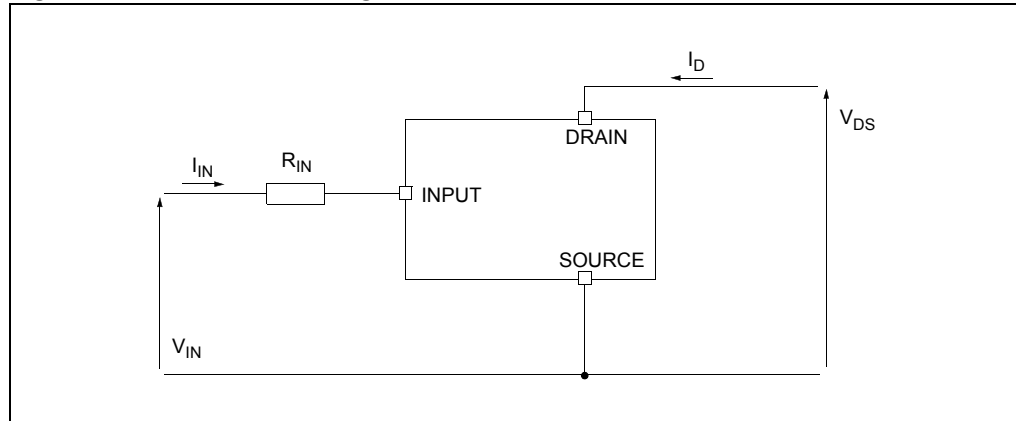

2.1 Absolute maximum ratings

Table 2. Absolute maximum ratings

Symbol	Parameter	Value			Unit
		SOT-223	SO-8	DPAK/IPAK	
V_{DS}	Drain-source voltage ($V_{IN}=0$ V)	Internally clamped			V
V_{IN}	Input voltage	Internally clamped			V
I_{IN}	Input current	+/-20			mA
$R_{IN\ MIN}$	Minimum input series impedance	150			Ω
I_D	Drain current	Internally limited			A
I_R	Reverse DC output current	-10.5			A
V_{ESD1}	Electrostatic discharge ($R=1.5$ K Ω , $C=100$ pF)	4000			V
V_{ESD2}	Electrostatic discharge on output pin only ($R=330$ Ω , $C=150$ pF)	16500			V
P_{tot}	Total dissipation at $T_c=25$ °C	7	4.6	60	W
E_{MAX}	Maximum switching energy ($L=0.7$ mH; $R_L=0$ Ω ; $V_{bat}=13.5$ V; $T_{jstart}=150$ °C; $I_L=9$ A)	40		40	mJ
E_{MAX}	Maximum switching energy ($L=0.6$ mH; $R_L=0$ Ω ; $V_{bat}=13.5$ V; $T_{jstart}=150$ °C; $I_L=9$ A)		37		mJ
T_j	Operating junction temperature	Internally limited			°C
T_c	Case operating temperature	Internally limited			°C
T_{stg}	Storage temperature	-55 to 150			°C

2.2 Thermal data

Table 3. Thermal data

Symbol	Parameter	Value				Unit
		SOT-223	SO-8	DPAK	IPAK	
$R_{thj-case}$	Thermal resistance junction-case max	18		2.1	2.1	°C/W
$R_{thj-lead}$	Thermal resistance junction-lead max		27			°C/W
$R_{thj-amb}$	Thermal resistance junction-ambient max	96 ⁽¹⁾	90 ⁽¹⁾	65 ⁽¹⁾	102	°C/W

1. When mounted on a standard single-sided FR4 board with 0.5 mm² of Cu (at least 35 µm thick) connected to all DRAIN pins.

2.3 Electrical characteristics

-40 °C < T_j < 150 °C, unless otherwise specified.

Table 4. Electrical characteristics

Symbol	Parameter	Test conditions	Min	Typ	Max	Unit
Off						
V_{CLAMP}	Drain-source clamp voltage	$V_{IN}=0$ V; $I_D=3.5$ A	40	45	55	V
V_{CLTH}	Drain-source clamp threshold voltage	$V_{IN}=0$ V; $I_D=2$ mA	36			V
V_{INTH}	Input threshold voltage	$V_{DS}=V_{IN}$; $I_D=1$ mA	0.5		2.5	V
I_{ISS}	Supply current from input pin	$V_{DS}=0$ V; $V_{IN}=5$ V		100	150	µA
V_{INCL}	Input-source clamp voltage	$I_{IN}=1$ mA $I_{IN}=-1$ mA	6 -1.0	6.8	8 -0.3	V
I_{DSS}	Zero input voltage drain current ($V_{IN}=0$ V)	$V_{DS}=13$ V; $V_{IN}=0$ V; $T_j=25$ °C $V_{DS}=25$ V; $V_{IN}=0$ V			30 75	µA
On						
$R_{DS(on)}$	Static drain-source on resistance	$V_{IN}=5$ V; $I_D=3.5$ A; $T_j=25$ °C $V_{IN}=5$ V; $I_D=3.5$ A			60 120	mΩ
Dynamic ($T_j=25$ °C, unless otherwise specified)						
$g_{fs}^{(1)}$	Forward transconductance	$V_{DD}=13$ V; $I_D=3.5$ A		9		S
C_{OSS}	Output capacitance	$V_{DS}=13$ V; $f=1$ MHz; $V_{IN}=0$ V		220		pF

Table 4. Electrical characteristics (continued)

Symbol	Parameter	Test conditions	Min	Typ	Max	Unit	
Switching ($T_j=25\text{ }^\circ\text{C}$, unless otherwise specified)							
$t_{d(on)}$	Turn-on delay time	$V_{DD}=15\text{ V}$; $I_D=3.5\text{ A}$ $V_{gen}=5\text{ V}$; $R_{gen}=R_{IN\text{ MIN}}=150\ \Omega$ (see figure Figure 4.)		100	300	ns	
t_r	Rise time			470	1500	ns	
$t_{d(off)}$	Turn-off delay time			500	1500	ns	
t_f	Fall time			350	1000	ns	
$t_{d(on)}$	Turn-on delay time	$V_{DD}=15\text{ V}$; $I_D=3.5\text{ A}$ $V_{gen}=5\text{ V}$; $R_{gen}=2.2\text{ K}\Omega$ (see figure Figure 4.)		0.75	2.3	μs	
t_r	Rise time			4.6	14.0	μs	
$t_{d(off)}$	Turn-off delay time			5.4	16.0	μs	
t_f	Fall time			3.6	11.0	μs	
$(di/dt)_{on}$	Turn-on current slope	$V_{DD}=15\text{ V}$; $I_D=3.5\text{ A}$ $V_{gen}=5\text{ V}$; $R_{gen}=R_{IN\text{ MIN}}=150\ \Omega$		6.5		$\text{A}/\mu\text{s}$	
Q_i	Total input charge	$V_{DD}=12\text{ V}$; $I_D=3.5\text{ A}$; $V_{IN}=5\text{ V}$ $I_{gen}=2.13\text{ mA}$ (see figure Figure 7.)		18		nC	
Source drain diode ($T_j=25\text{ }^\circ\text{C}$, unless otherwise specified)							
$V_{SD}^{(1)}$	Forward on voltage	$I_{SD}=3.5\text{ A}$; $V_{IN}=0\text{ V}$		0.8		V	
t_{rr}	Reverse recovery time	$I_{SD}=3.5\text{ A}$; $di/dt=20\text{ A}/\mu\text{s}$ $V_{DD}=30\text{ V}$; $L=200\ \mu\text{H}$ (see test circuit, figure Figure 5.)		220		ns	
Q_{rr}	Reverse recovery charge				0.28		μC
I_{RRM}	Reverse recovery current				2.5		A
Protections ($-40\text{ }^\circ\text{C} < T_j < 150\text{ }^\circ\text{C}$, unless otherwise specified)							
I_{lim}	Drain current limit	$V_{IN}=5\text{ V}$; $V_{DS}=13\text{ V}$	6	9	12	A	
t_{dlim}	Step response current limit	$V_{IN}=5\text{ V}$; $V_{DS}=13\text{ V}$		4.0		μs	
T_{jsh}	Over temperature shutdown		150	175	200	$^\circ\text{C}$	
T_{jrs}	Over temperature reset		135			$^\circ\text{C}$	
I_{gf}	Fault sink current	$V_{IN}=5\text{ V}$; $V_{DS}=13\text{ V}$; $T_j=T_{jsh}$		15		mA	
E_{as}	Single pulse avalanche energy	starting $T_j=25\text{ }^\circ\text{C}$; $V_{DD}=24\text{ V}$ $V_{IN}=5\text{ V}$ $R_{gen}=R_{IN\text{ MIN}}=150\ \Omega$; $L=24\text{ mH}$ (see figures Figure 6. & Figure 8.)	200			mJ	

1. Pulsed: Pulse duration = 300 μs , duty cycle 1.5 %

3 Protection features

During normal operation, the input pin is electrically connected to the gate of the internal Power MOSFET through a low impedance path.

The device then behaves like a standard Power MOSFET and can be used as a switch from DC up to 50 kHz. The only difference from the user's standpoint is that a small DC current I_{ISS} (typ. 100 μ A) flows into the input pin in order to supply the internal circuitry.

The device integrates:

- Overvoltage clamp protection: internally set at 45 V, along with the rugged avalanche characteristics of the Power MOSFET stage give this device unrivalled ruggedness and energy handling capability. This feature is mainly important when driving inductive loads.
- Linear current limiter circuit: limits the drain current I_D to I_{lim} whatever the input pin voltages. When the current limiter is active, the device operates in the linear region, so power dissipation may exceed the capability of the heatsink. Both case and junction temperatures increase, and if this phase lasts long enough, junction temperature may reach the over temperature threshold T_{jsh} .
- Over temperature and short circuit protection: these are based on sensing the chip temperature and are not dependent on the input voltage. The location of the sensing element on the chip in the power stage area ensures fast, accurate detection of the junction temperature. Over temperature cutout occurs in the range 150 to 190 °C, a typical value being 170 °C. The device is automatically restarted when the chip temperature falls of about 15 °C below shutdown temperature.
- Status feedback: in the case of an over temperature fault condition ($T_j > T_{jsh}$), the device tries to sink a diagnostic current I_{gf} through the input pin in order to indicate fault condition. If driven from a low impedance source, this current may be used in order to warn the control circuit of a device shutdown. If the drive impedance is high enough so that the input pin driver is not able to supply the current I_{gf} , the input pin will fall to 0 V. This will not however affect the device operation: no requirement is put on the current capability of the input pin driver except to be able to supply the normal operation drive current I_{ISS} .

Additional features of this device are ESD protection according to the Human Body model and the ability to be driven from a TTL logic circuit.

Figure 4. Switching time test circuit for resistive load

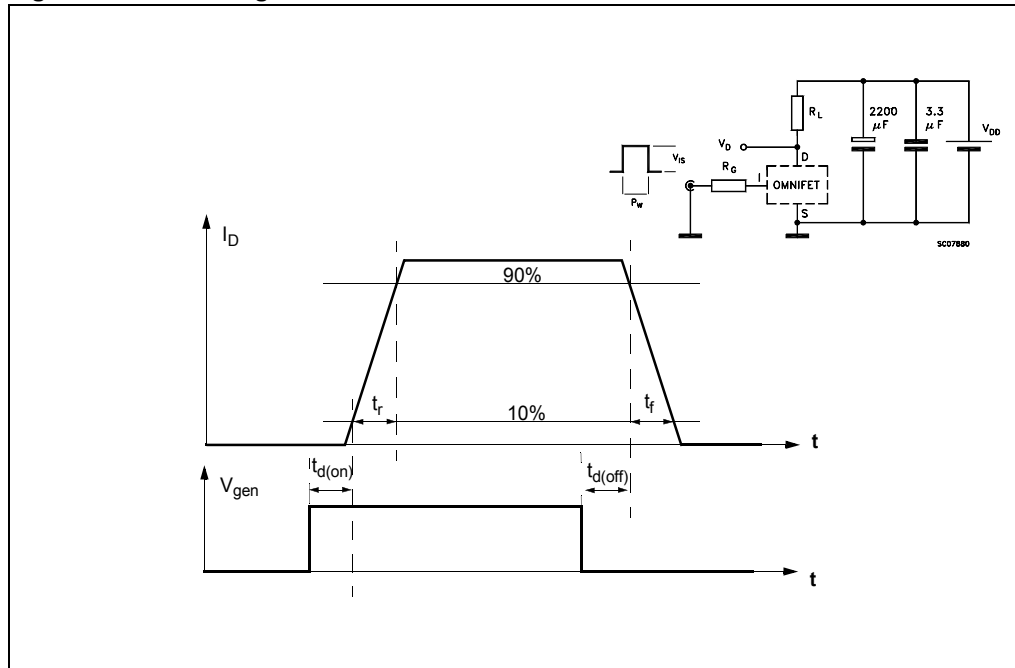

Figure 5. Test circuit for diode recovery times

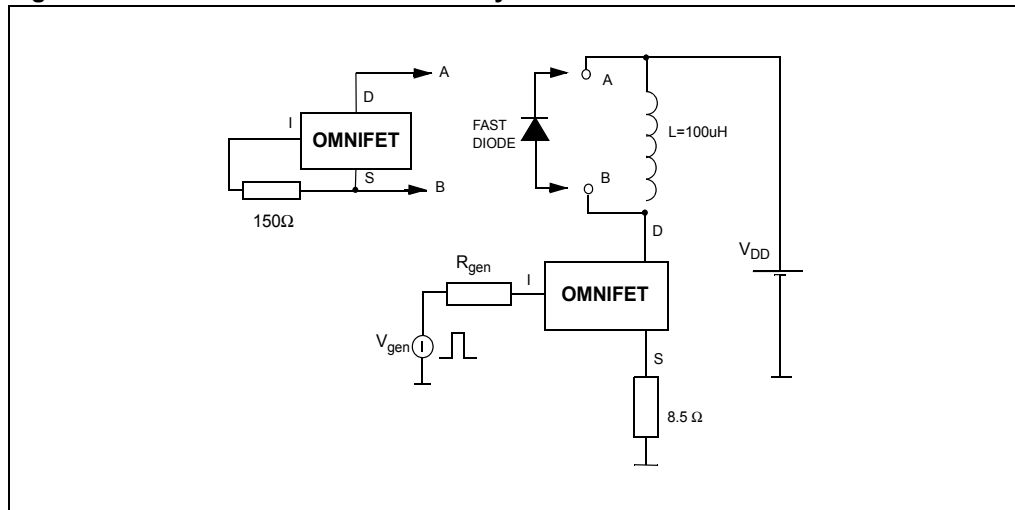

Figure 6. Unclamped inductive load test circuits

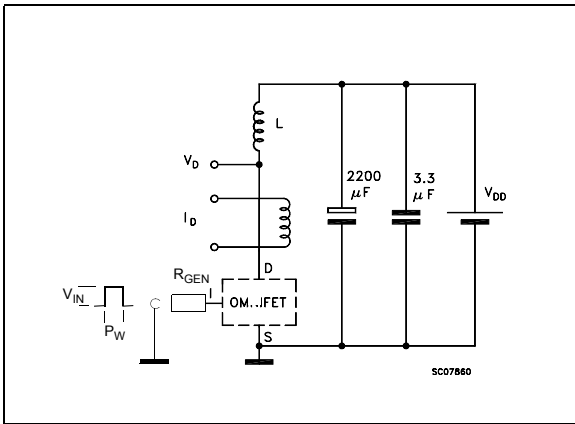

Figure 7. Input charge test circuit

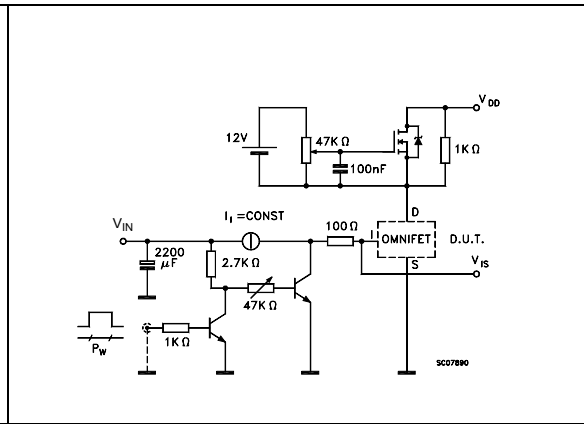
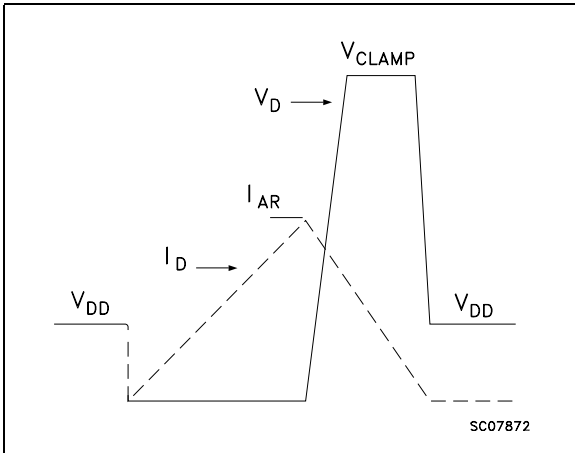

Figure 8. Unclamped inductive waveforms



3.1 Electrical characteristics curves

Figure 9. Derating curve

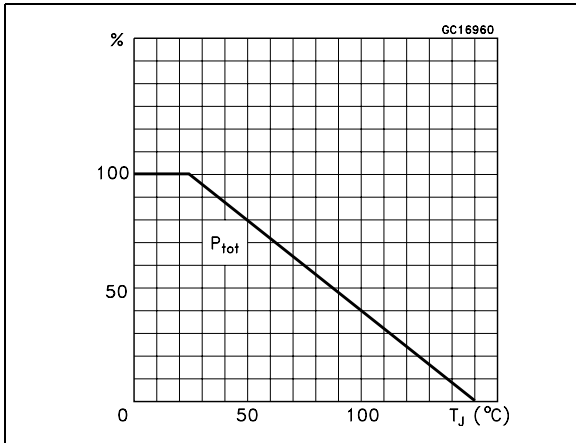

Figure 10. Transconductance

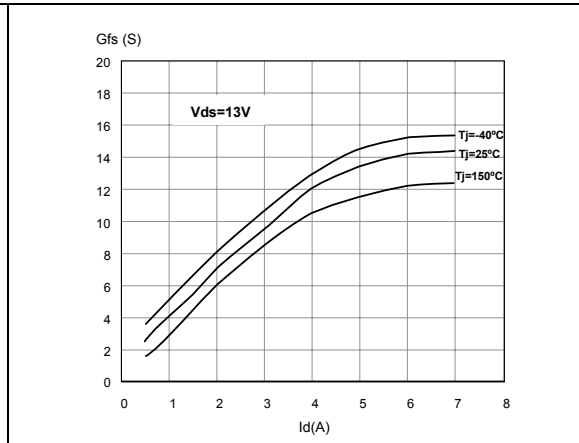

Figure 11. Static drain-source on resistance vs input voltage (part 1/2)

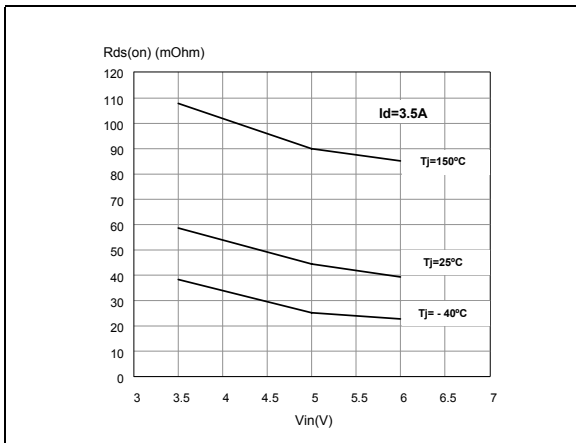

Figure 12. Static drain-source on resistance vs input voltage (part 2/2)

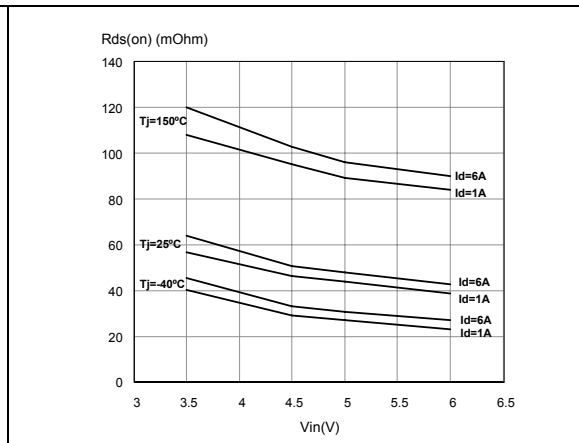

Figure 13. Source-drain diode forward characteristics

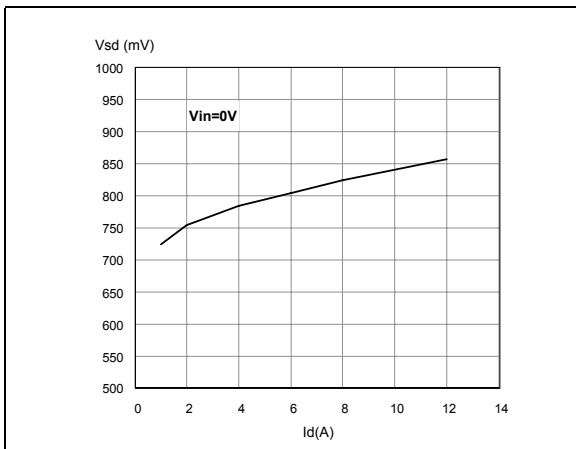

Figure 14. Static drain source on resistance

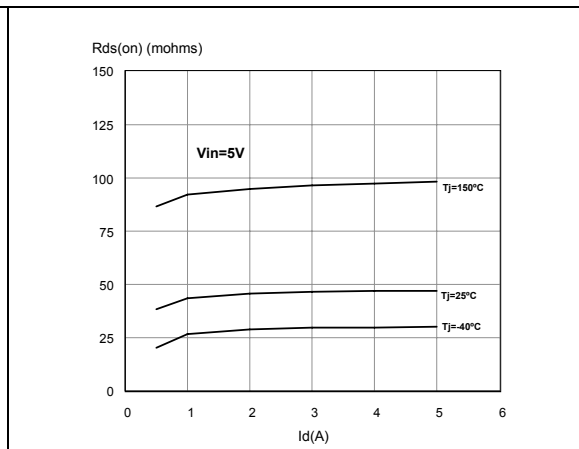

Figure 15. Turn-on current slope (part 1/2)

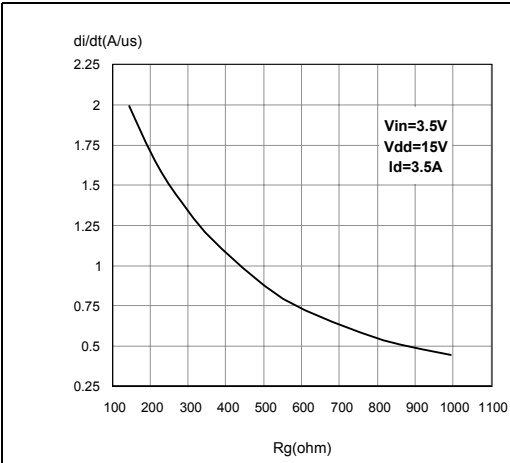

Figure 16. Turn-on current slope (part 2/2)

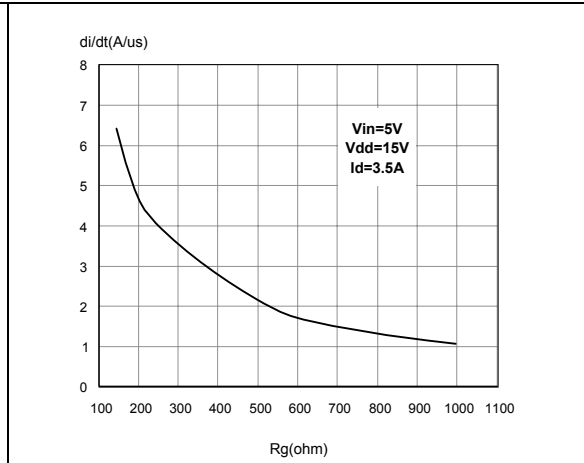

Figure 17. Transfer characteristics

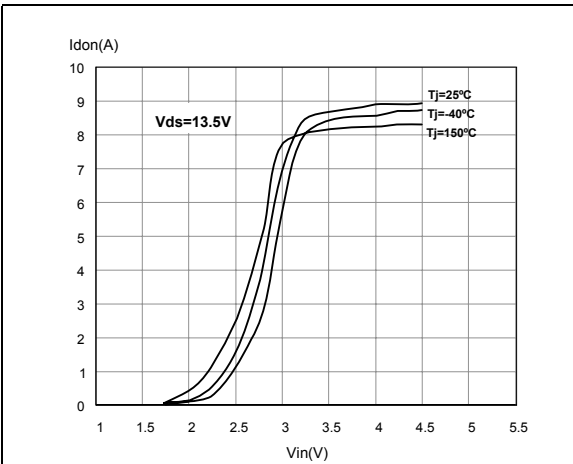

Figure 18. Static drain-source on resistance vs Id

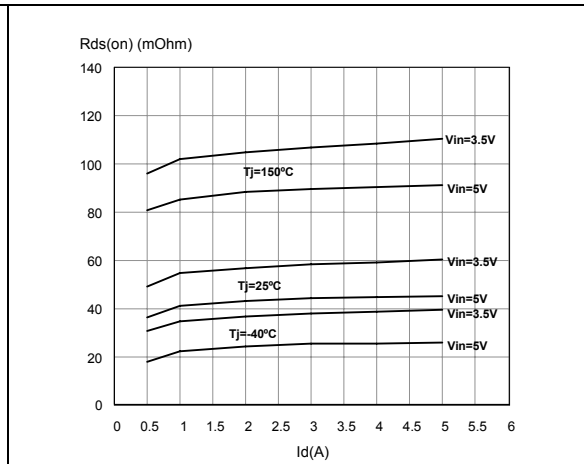

Figure 19. Input voltage vs input charge

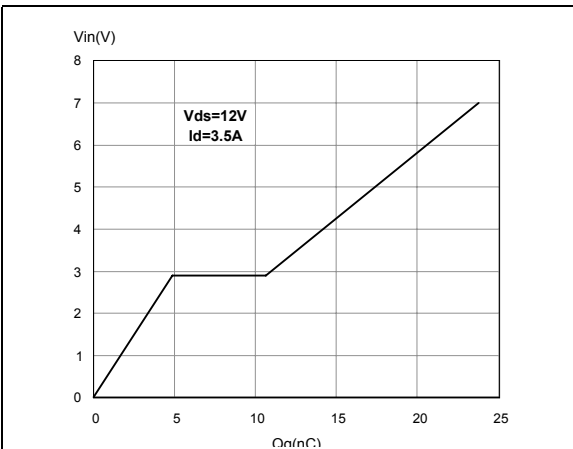

Figure 20. Turn-off drain source voltage slope (part 1/2)

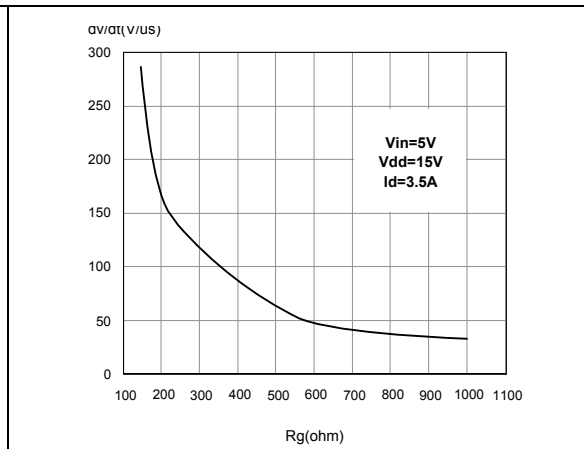

Figure 21. Turn-off drain source voltage slope (part 2/2) Figure 22. Capacitance variations

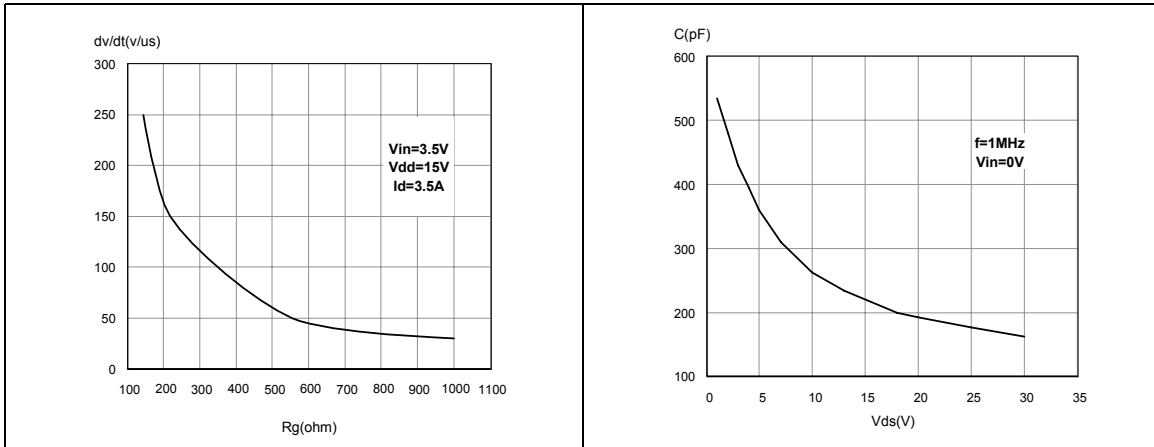

Figure 23. Output characteristics

Figure 24. Normalized on resistance vs temperature

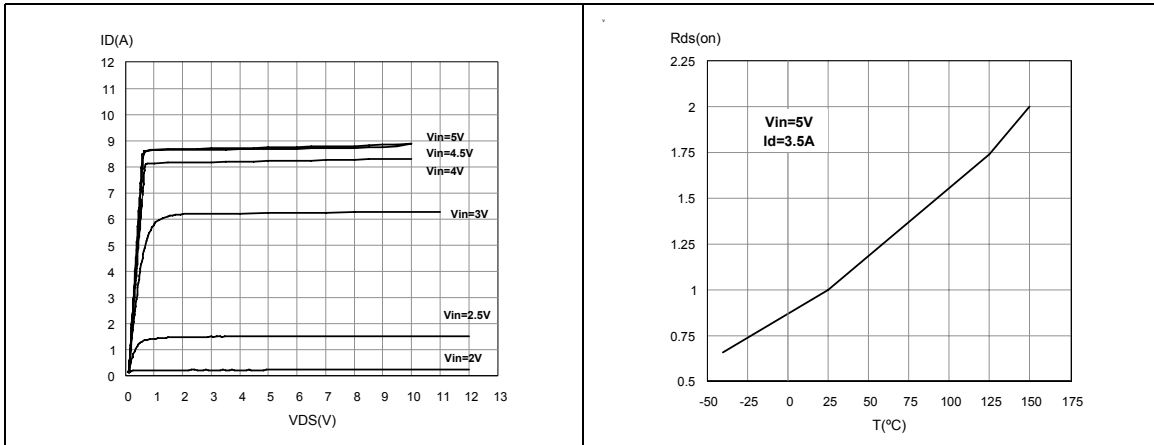

Figure 25. Switching time resistive load (part 1/2)

Figure 26. Switching time resistive load (part 2/2)

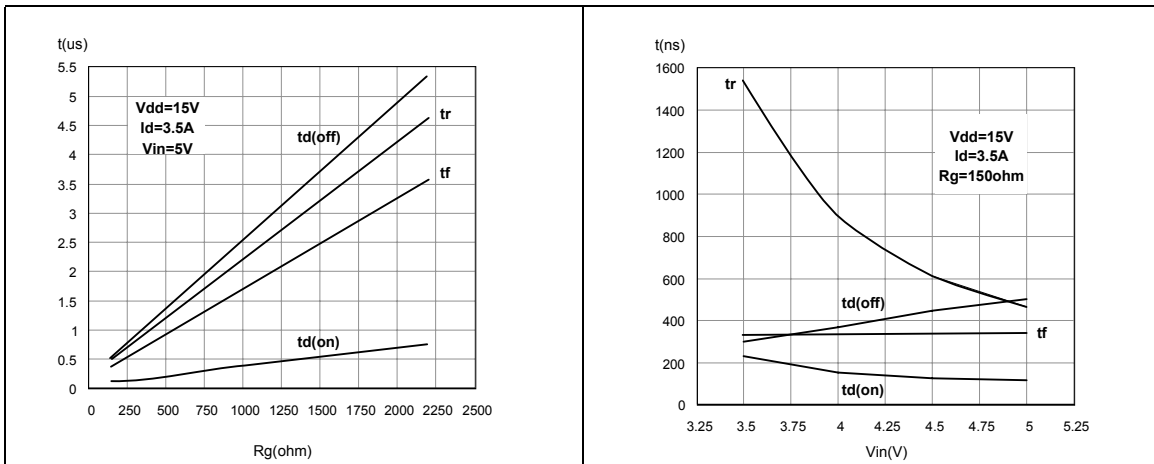

Figure 27. Normalized input threshold voltage vs temperature

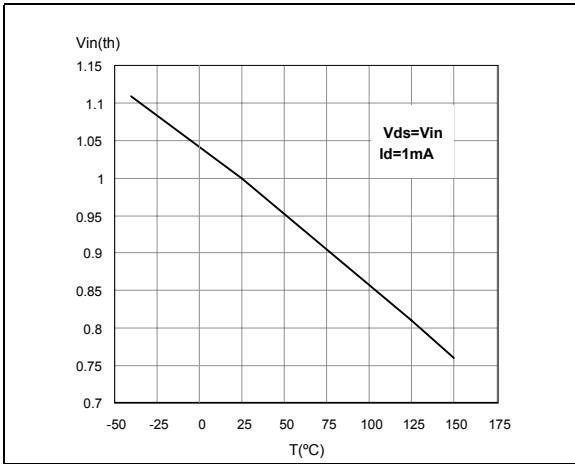

Figure 28. Normalized current limit vs junction temperature

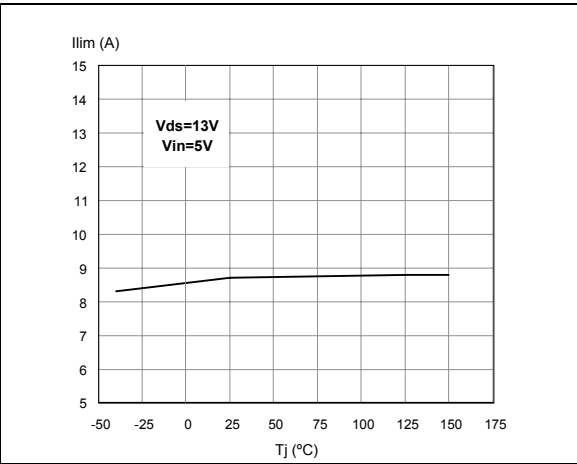
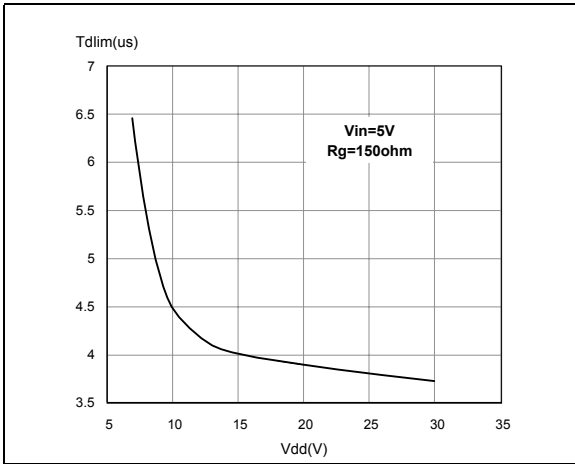
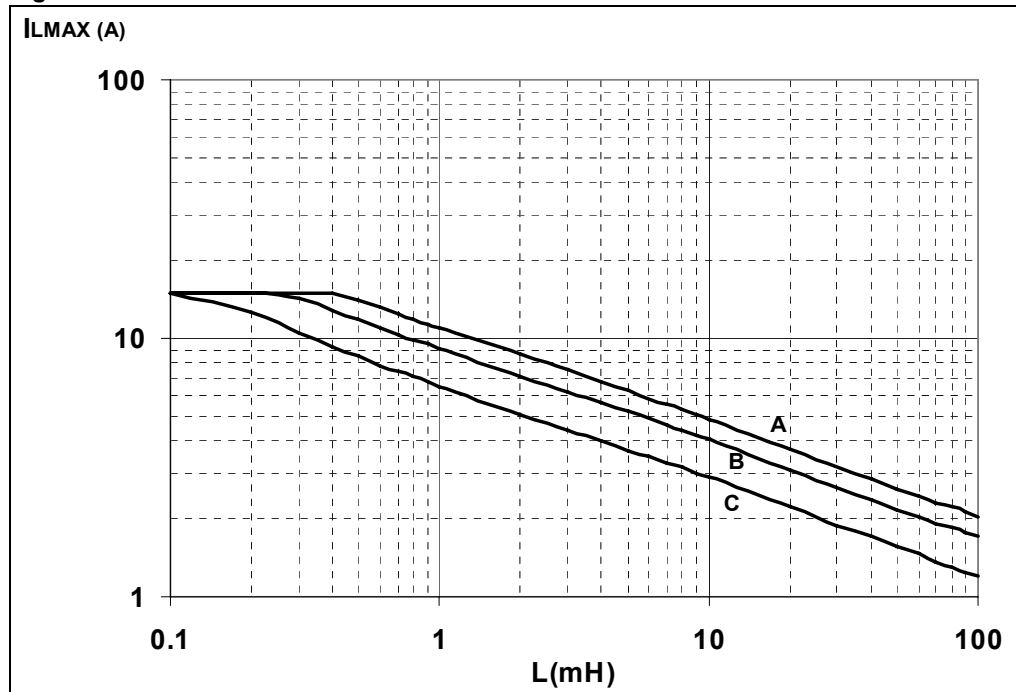

Figure 29. Step response current limit



3.2 SO-8 maximum demagnetization energy

Figure 30. SO-8 maximum turn-off current versus load inductance



Legend

- A = Single Pulse at $T_{Jstart}=150\text{ }^{\circ}\text{C}$
- B = Repetitive pulse at $T_{Jstart}=100\text{ }^{\circ}\text{C}$
- C = Repetitive Pulse at $T_{Jstart}=125\text{ }^{\circ}\text{C}$

Conditions:

$V_{CC}=13.5\text{ V}$

Values are generated with $R_L=0\ \Omega$. In case of repetitive pulses, T_{Jstart} (at beginning of each demagnetization) of every pulse must not exceed the temperature specified above for curves B and C.

Figure 31. SO-8 demagnetization

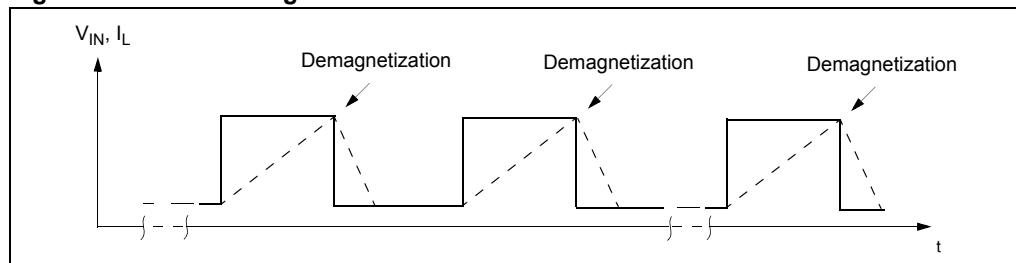

3.3 DPAK maximum demagnetization energy

Figure 32. DPAK maximum turn-off current versus load inductance

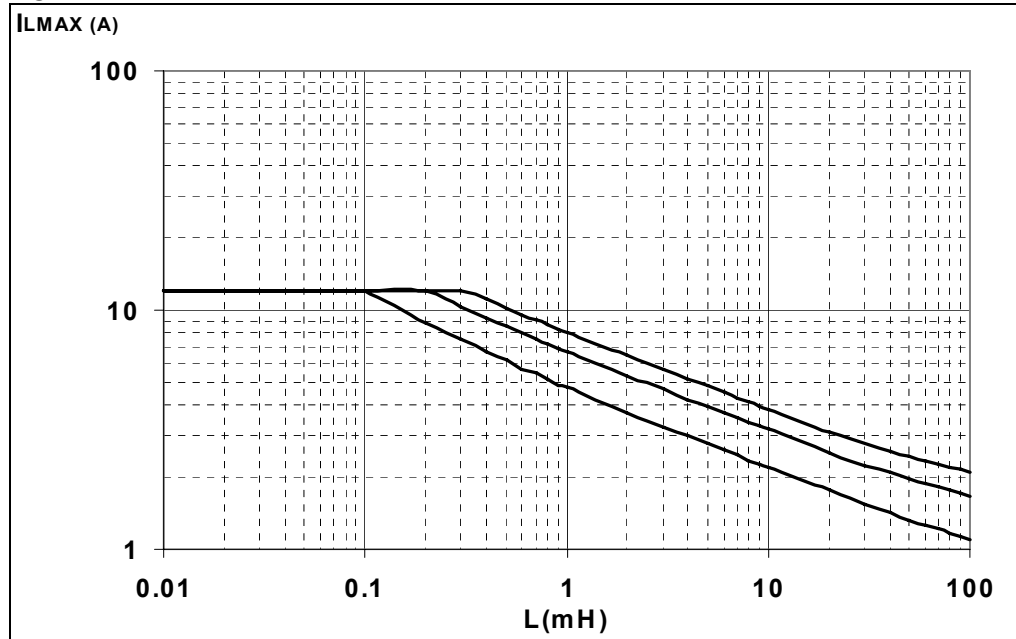

Legend

A = Single Pulse at $T_{Jstart}=150\text{ }^{\circ}\text{C}$

B = Repetitive pulse at $T_{Jstart}=100\text{ }^{\circ}\text{C}$

C = Repetitive Pulse at $T_{Jstart}=125\text{ }^{\circ}\text{C}$

Conditions:

$V_{CC}=13.5\text{ V}$

Values are generated with $R_L=0\ \Omega$. In case of repetitive pulses, T_{Jstart} (at beginning of each demagnetization) of every pulse must not exceed the temperature specified above for curves B and C.

Figure 33. DPAK demagnetization

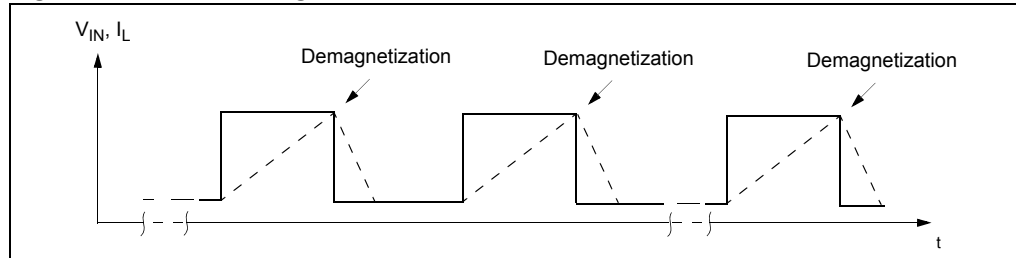

3.4 SOT-223 maximum demagnetization energy

Figure 34. SOT-223 maximum turn-off current versus load inductance

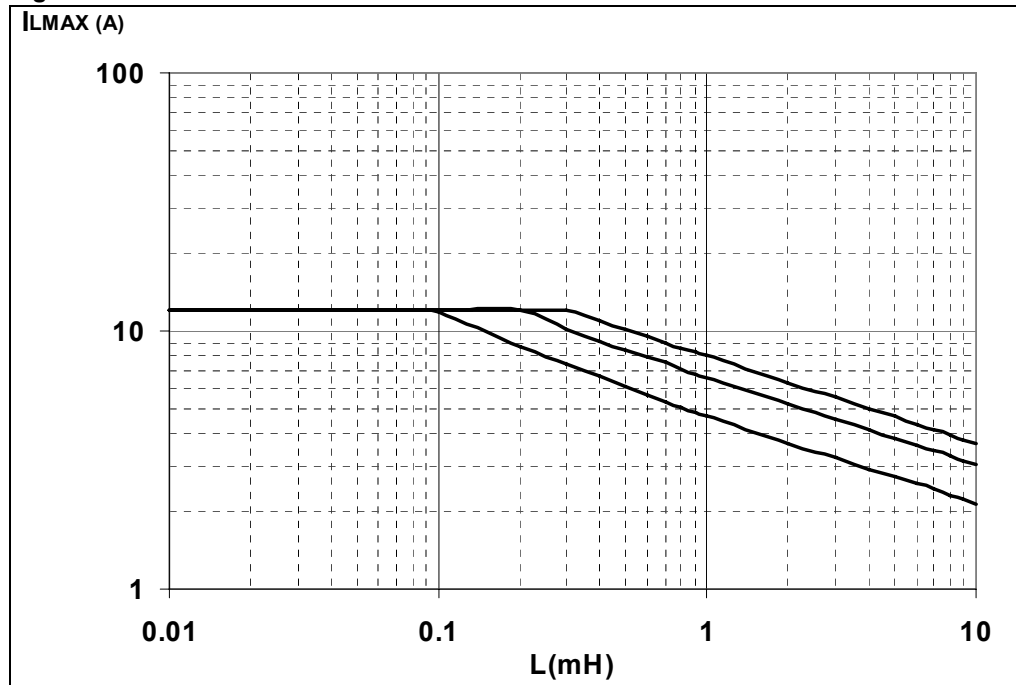

Legend

A = Single Pulse at $T_{Jstart}=150\text{ °C}$

B = Repetitive pulse at $T_{Jstart}=100\text{ °C}$

C = Repetitive Pulse at $T_{Jstart}=125\text{ °C}$

Conditions:

$V_{CC}=13.5\text{ V}$

Values are generated with $R_L=0\ \Omega$. In case of repetitive pulses, T_{Jstart} (at beginning of each demagnetization) of every pulse must not exceed the temperature specified above for curves B and C.

Figure 35. SOT-223 demagnetization

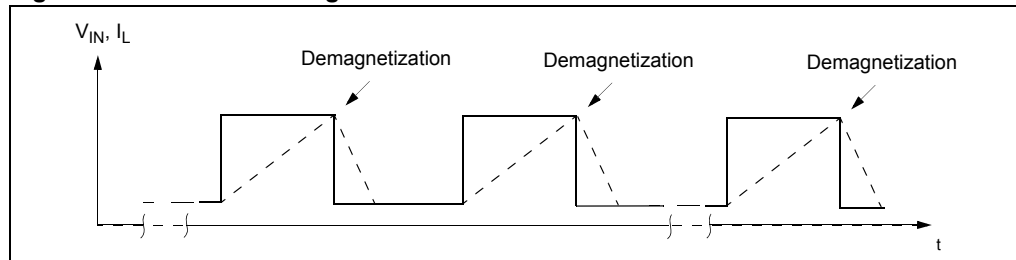

4 Package and PCB thermal data

4.1 SO-8 thermal data

Figure 36. SO-8 PC board

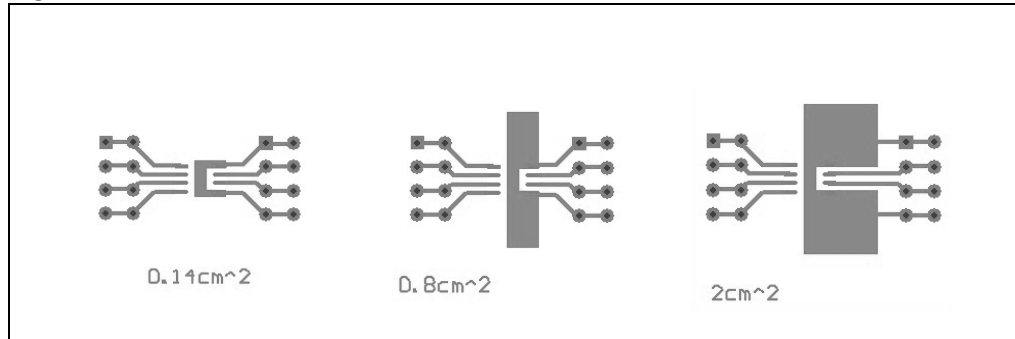

Note: Layout condition of R_{th} and Z_{th} measurements (PCB FR4 area=58 mm x 58 mm, PCB thickness=2 mm, Cu thickness=35 μ m, Copper areas: 0.14 cm², 0.8 cm², 2 cm²).

Figure 37. $R_{thj-amb}$ vs PCB copper area in open box free air condition

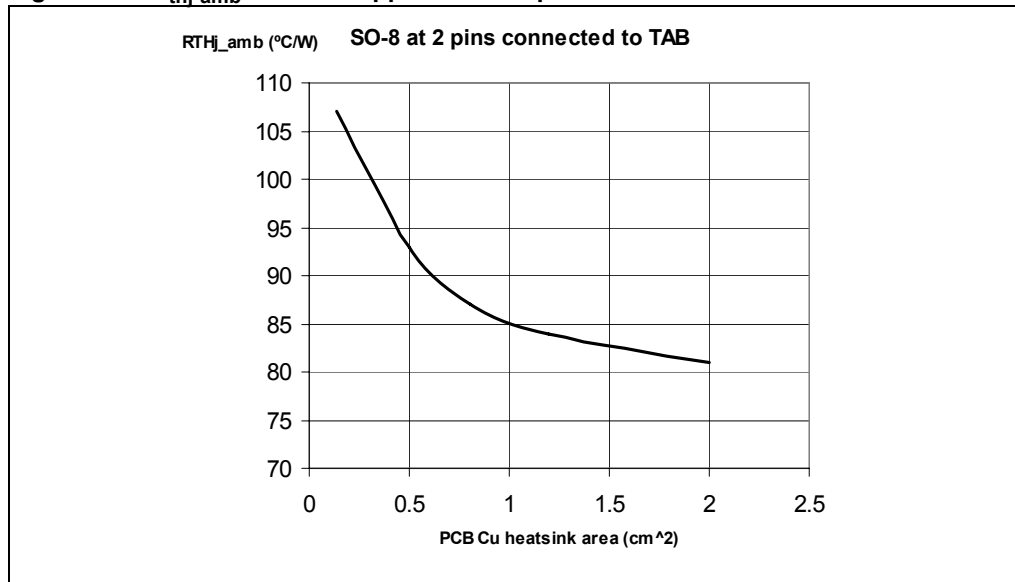

Figure 38. SO-8 thermal impedance junction ambient single pulse

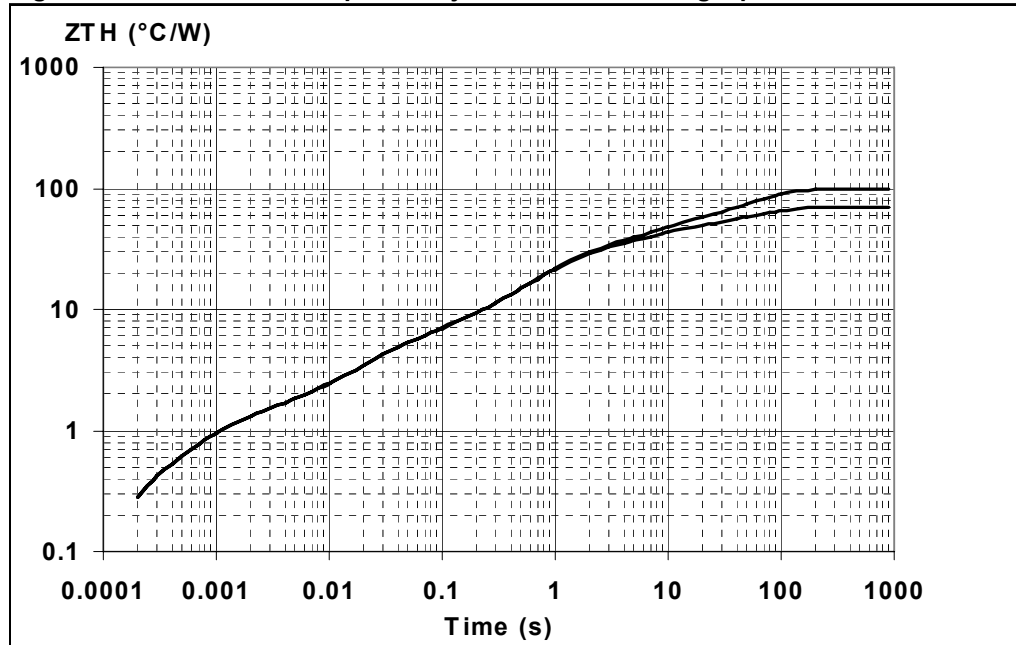
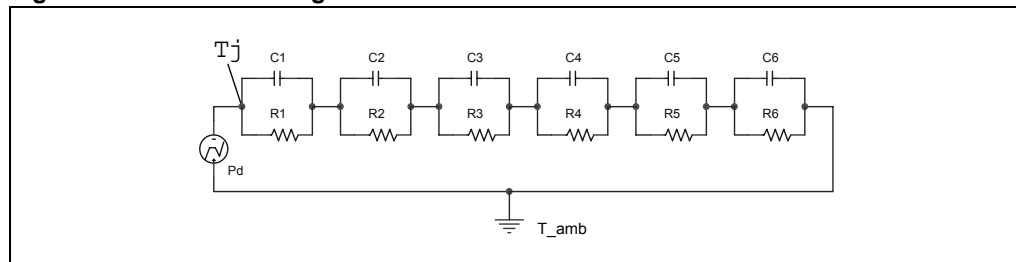

Figure 39. Thermal fitting model of an OMNIFET II in SO-8



Equation 1 Pulse calculation formula

$$Z_{TH\delta} = R_{TH} \cdot \delta + Z_{THtp}(1 - \delta)$$

where $\delta = t_p/T$

Table 5. SO-8 thermal parameter

Area/island (cm ²)	Footprint	2
R1 (°C/W)	0.2	
R2 (°C/W)	0.9	
R3 (°C/W)	3.5	
R4 (°C/W)	21	
R5 (°C/W)	16	
R6 (°C/W)	58	28
C1 (W.s/°C)	3.00E-04	

Table 5. SO-8 thermal parameter (continued)

Area/island (cm ²)	Footprint	2
C2 (W.s/°C)	9.00E-04	
C3 (W.s/°C)	7.50E-03	
C4 (W.s/°C)	0.045	
C5 (W.s/°C)	0.35	
C6 (W.s/°C)	1.05	2

4.2 SOT-223 thermal data

Figure 40. SOT-223 PC board

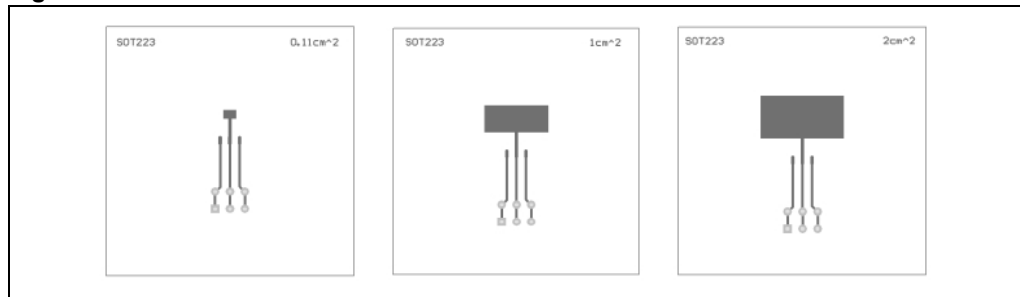

Note: Layout condition of R_{th} and Z_{th} measurements (PCB FR4 area=58 mm x 58 mm, PCB thickness=2 mm, Cu thickness=35 μ m, Copper areas: 0.11 cm², 1 cm², 2 cm²).

Figure 41. $R_{thj-amb}$ vs PCB copper area in open box free air condition

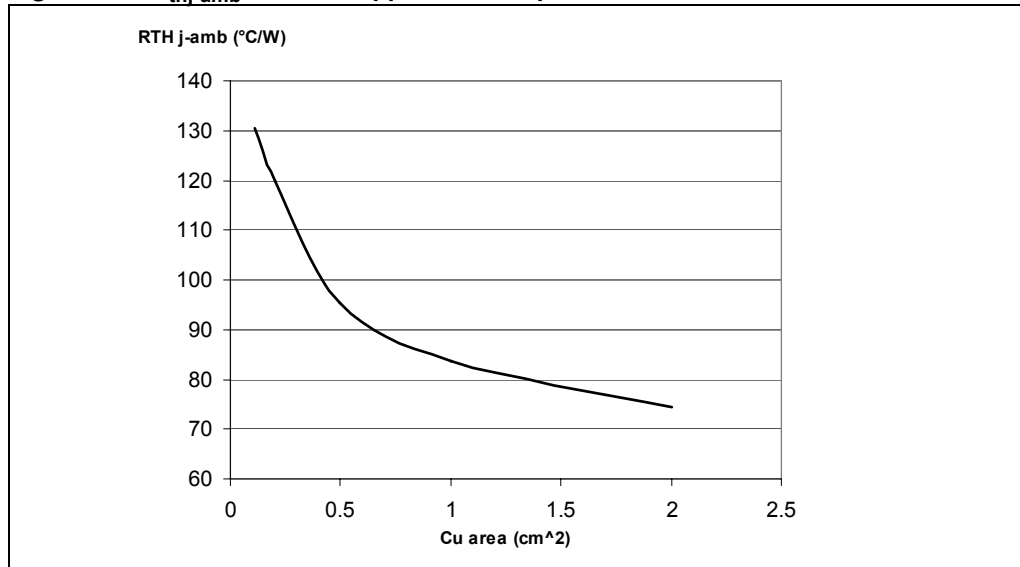

Figure 42. SOT-223 thermal impedance junction ambient single pulse

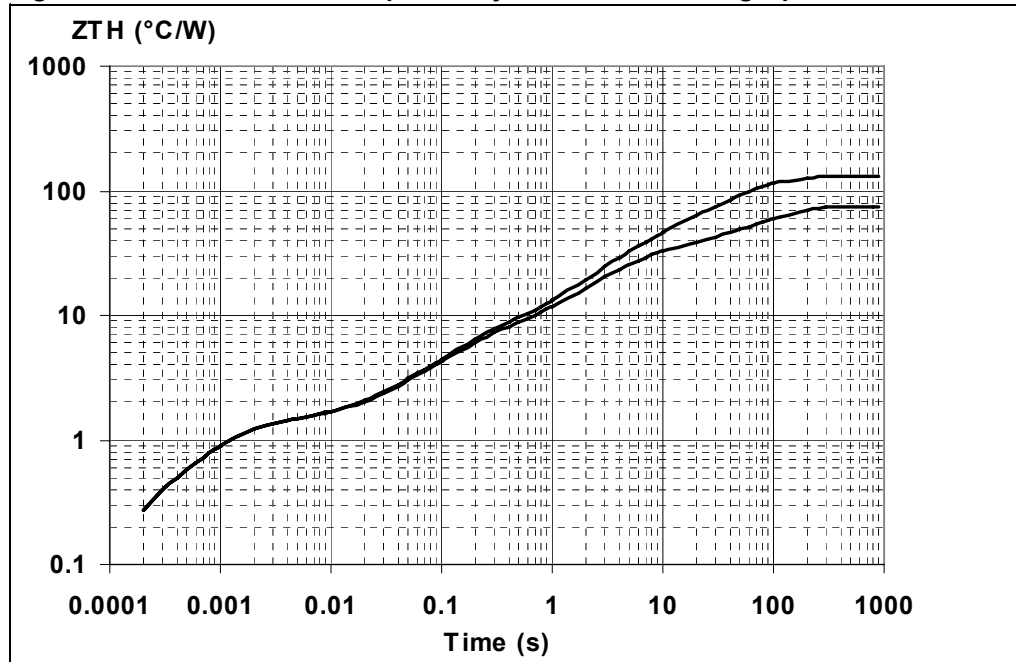
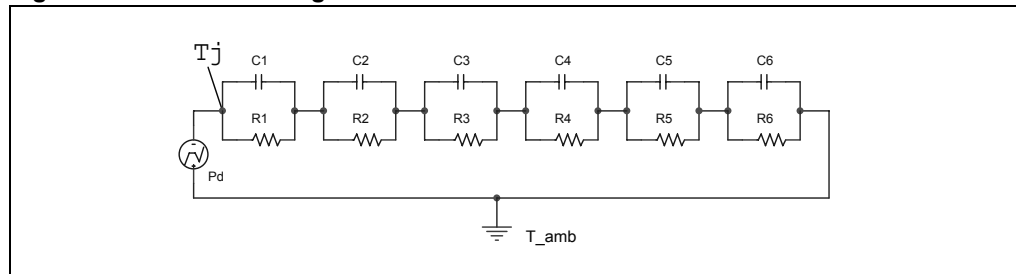

Figure 43. Thermal fitting model of an OMNIFET II in SOT-223



Equation 2 Pulse calculation formula

$$Z_{TH\delta} = R_{TH} \cdot \delta + Z_{THtp}(1 - \delta)$$

where $\delta = t_p/T$

Table 6. SOT-223 thermal parameter

Area/island (cm ²)	Footprint	2
R1 (°C/W)	0.2	
R2 (°C/W)	1.1	
R3 (°C/W)	4.5	
R4 (°C/W)	24	
R5 (°C/W)	0.1	
R6 (°C/W)	100	45
C1 (W.s/°C)	3.00E-04	

Table 6. SOT-223 thermal parameter (continued)

Area/island (cm ²)	Footprint	2
C2 (W.s/°C)	9.00E-04	
C3 (W.s/°C)	3.00E-02	
C4 (W.s/°C)	0.16	
C5 (W.s/°C)	1000	
C6 (W.s/°C)	0.5	2

4.3 DPAK thermal data

Figure 44. DPAK PC board

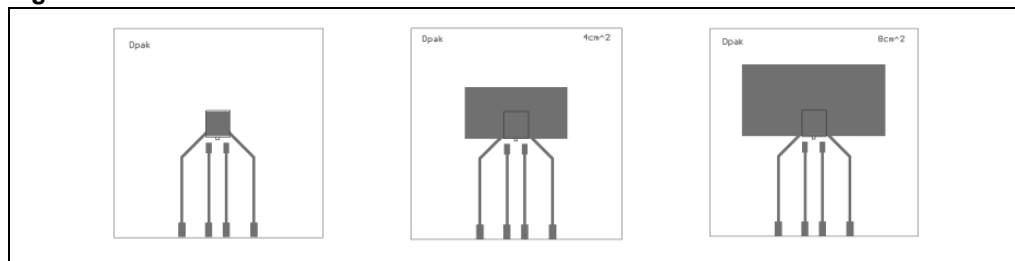

Note: Layout condition of R_{th} and Z_{th} measurements (PCB FR4 area=60 mm x 60 mm, PCB thickness=2 mm, Cu thickness=35µm, Copper areas: from minimum pad lay-out to 8 cm²).

Figure 45. $R_{thj-amb}$ vs PCB copper area in open box free air condition

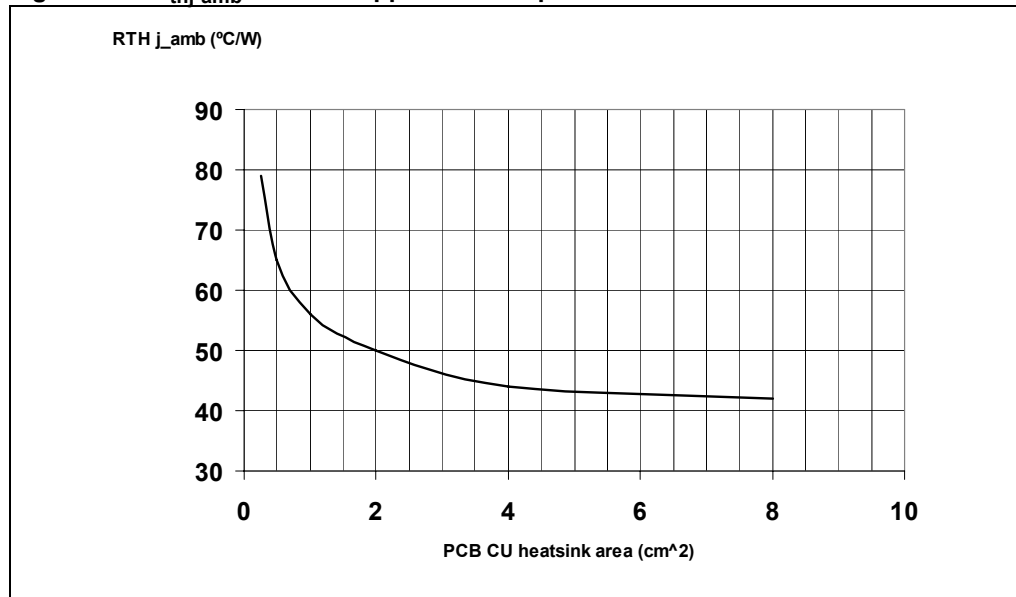

Figure 46. DPAK thermal impedance junction ambient single pulse

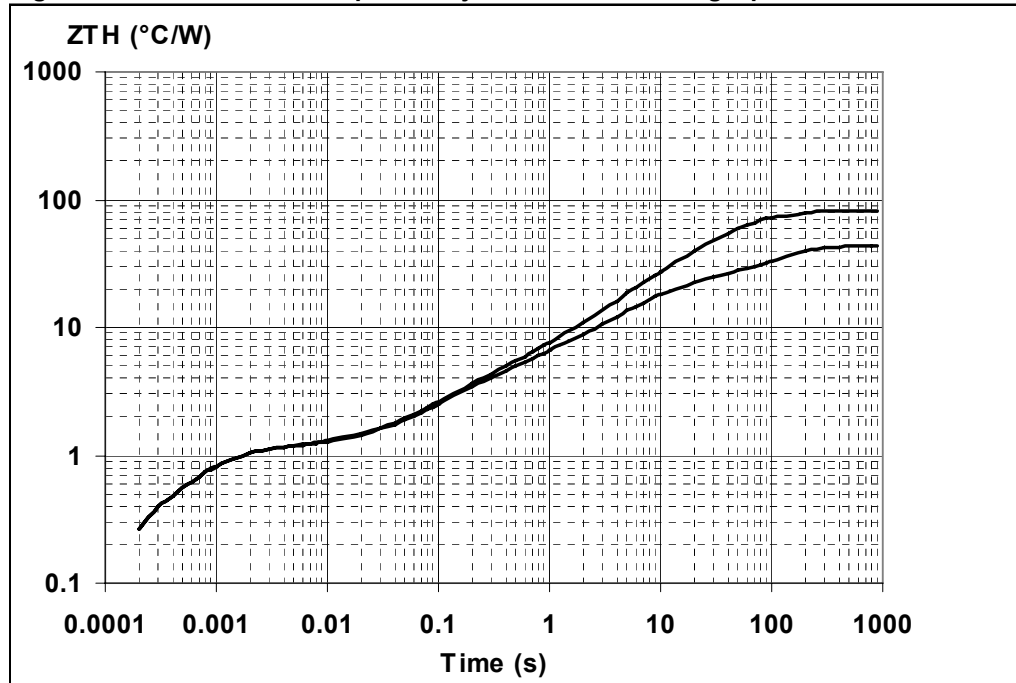
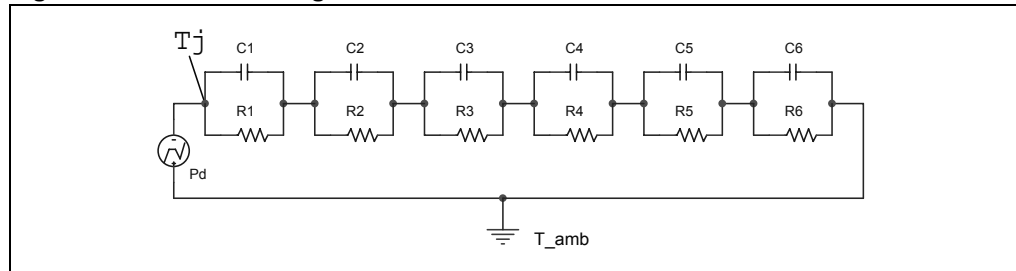

Figure 47. Thermal fitting model of an OMNIFET II in DPAK



Equation 3 Pulse calculation formula

$$Z_{TH\delta} = R_{TH} \cdot \delta + Z_{THtp}(1 - \delta)$$

where $\delta = t_p/T$

Table 7. DPAK thermal parameter

Area/island (cm ²)	Footprint	6
R1 (°C/W)	0.1	
R2 (°C/W)	0.35	
R3 (°C/W)	1.20	
R4 (°C/W)	2	
R5 (°C/W)	15	
R6 (°C/W)	61	24

Table 7. DPAK thermal parameter (continued)

Area/island (cm ²)	Footprint	6
C1 (W.s/°C)	0.0006	
C2 (W.s/°C)	0.0021	
C3 (W.s/°C)	0.05	
C4 (W.s/°C)	0.3	
C5 (W.s/°C)	0.45	
C6 (W.s/°C)	0.8	5

5 Package and packing information

In order to meet environmental requirements, ST offers these devices in different grades of ECOPACK® packages, depending on their level of environmental compliance. ECOPACK® specifications, grade definitions and product status are available at: www.st.com.

ECOPACK® is an ST trademark.

5.1 TO-251 (IPAK) mechanical data

Table 8. TO-251 (IPAK) mechanical data

Symbol	millimeters		
	Min.	Typ.	Max.
A	2.2		2.4
A1	0.9		1.1
A3	0.7		1.3
B	0.64		0.9
B2	5.2		5.4
B3			0.85
B5		0.3	
B6			0.95
C	0.45		0.6
C2	0.48		0.6
D	6		6.2
E	6.4		6.6
G	4.4		4.6
H	15.9		16.3
L	9		9.4
L1	0.8		1.2
L2		0.8	1

Figure 48. TO-251 (IPAK) package dimensions

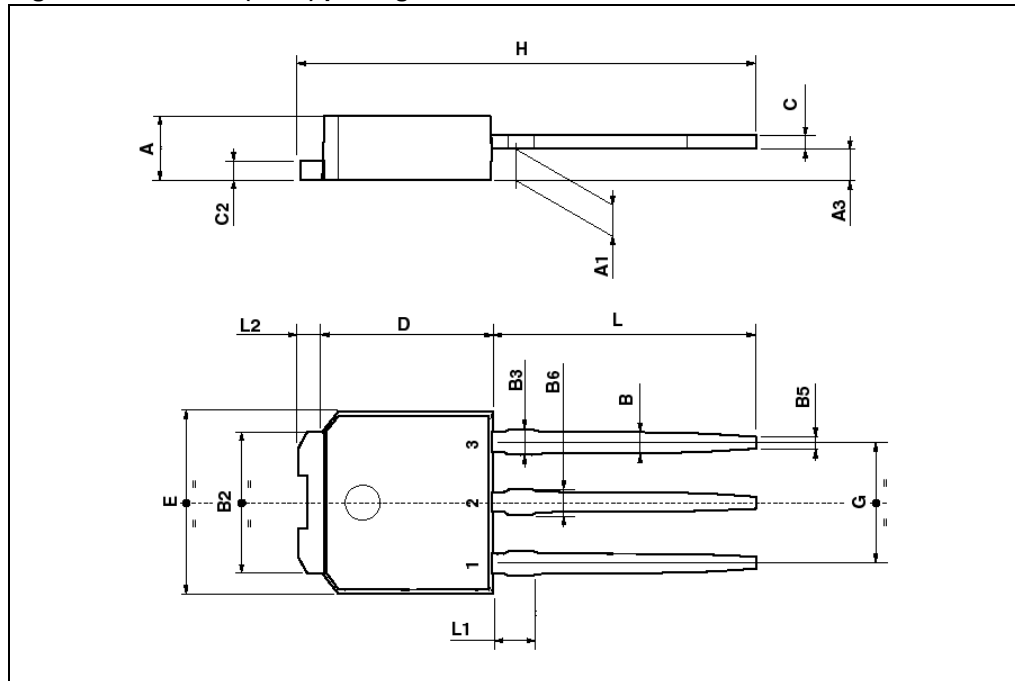

5.2 TO-252 (DPAK) mechanical data

Table 9. TO-252 (DPAK) mechanical data

Symbol	millimeters		
	Min.	Typ.	Max.
A	2.20		2.40
A1	0.90		1.10
A2	0.03		0.23
B	0.64		0.90
B2	5.20		5.40
C	0.45		0.60
C2	0.48		0.60
D	6.00		6.20
D1		5.1	
E	6.40		6.60
E1		4.7	
e		2.28	
G	4.40		4.60
H	9.35		10.10

Table 9. TO-252 (DPAK) mechanical data (continued)

Symbol	millimeters		
	Min.	Typ.	Max.
L2		0.8	
L4	0.60		1.00
R		0.2	
V2	0°	8°	
Package Weight	Gr. 0.29		

Figure 49. TO-252 (DPAK) package dimensions

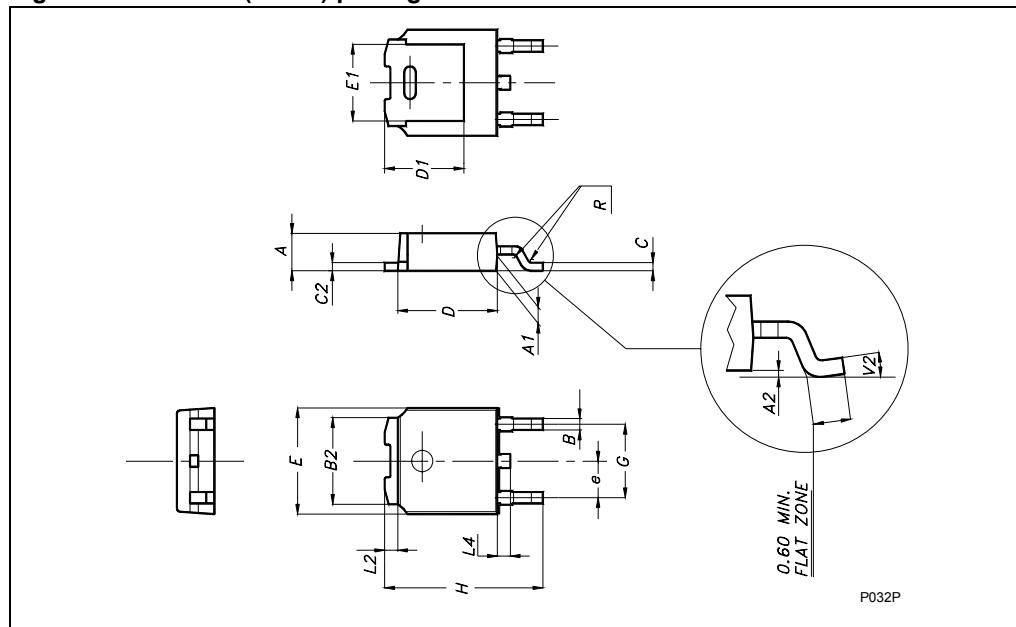

5.3 SOT-223 mechanical data

Table 10. SOT-223 mechanical data

Symbol	millimeters		
	Min.	Typ.	Max.
A			1.8
B	0.6	0.7	0.85
B1	2.9	3	3.15
c	0.24	0.26	0.35
D	6.3	6.5	6.7
e		2.3	

Table 10. SOT-223 mechanical data (continued)

Symbol	millimeters		
	Min.	Typ.	Max.
e1		4.6	
E	3.3	3.5	3.7
H	6.7	7	7.3
V	10 (max)		
A1	0.02		0.1

Figure 50. SOT-223 package dimensions

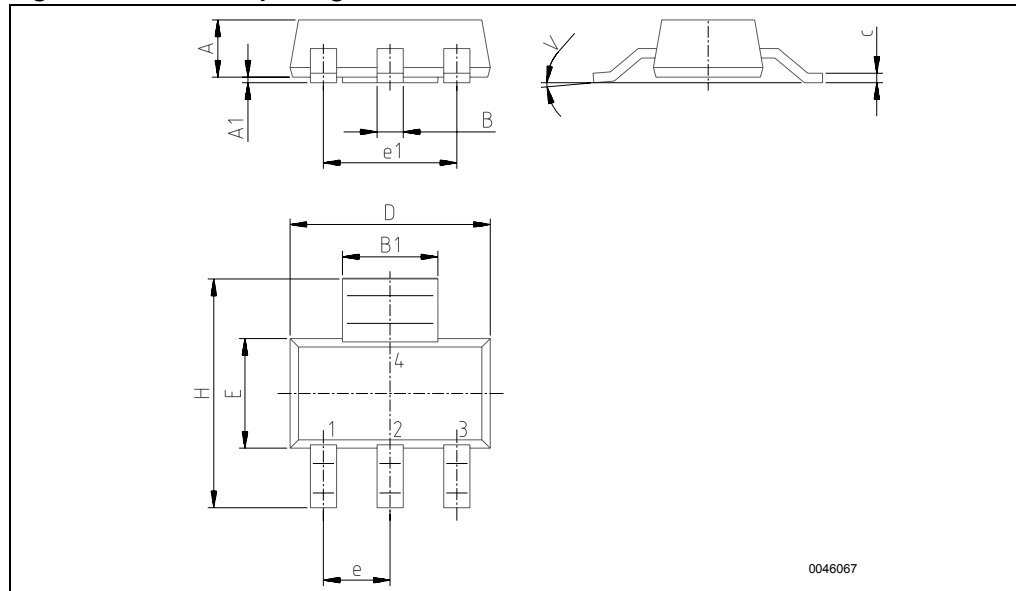

5.4 SO-8 mechanical data

Table 11. SO-8 mechanical data

Symbol	millimeters		
	Min	Typ	Max
A			1.75
a1	0.1		0.25
a2			1.65
a3	0.65		0.85
b	0.35		0.48
A			1.75
A1	0.10		0.25

Table 11. SO-8 mechanical data (continued)

Symbol	millimeters		
	Min	Typ	Max
A2	1.25		
b	0.28		0.48
c	0.17		0.23
D ⁽¹⁾	4.80	4.90	5.00
E	5.80	6.00	6.20
E1 ⁽²⁾	3.80	3.90	4.00
e		1.27	
h	0.25		0.50
L	0.40		1.27
L1		1.04	
k	0°		8°
ccc			0.10

1. Dimension "D" does not include mold flash, protrusions or gate burrs. Mold flash, protrusions or gate burrs shall not exceed 0.15 mm in total (both side).
2. Dimension "E1" does not include interlead flash or protrusions. Interlead flash or protrusions shall not exceed 0.25 mm per side.

Figure 51. SO-8 package dimensions

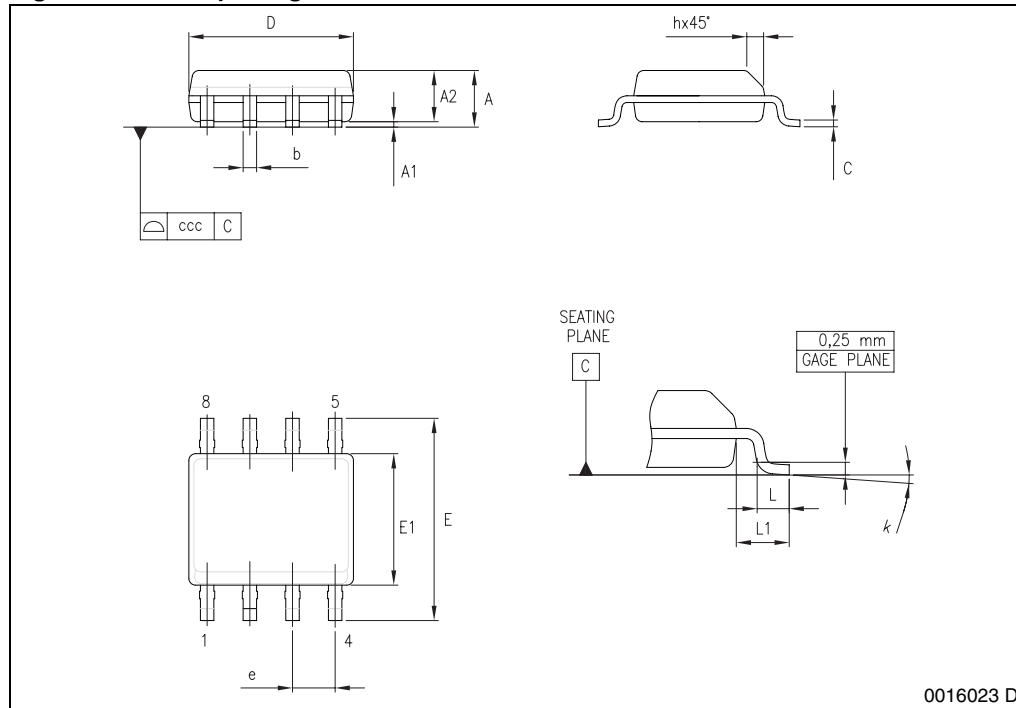

0016023 D

5.5 SOT-223 packing information

Figure 52. SOT-223 tape and reel shipment (suffix “TR”)

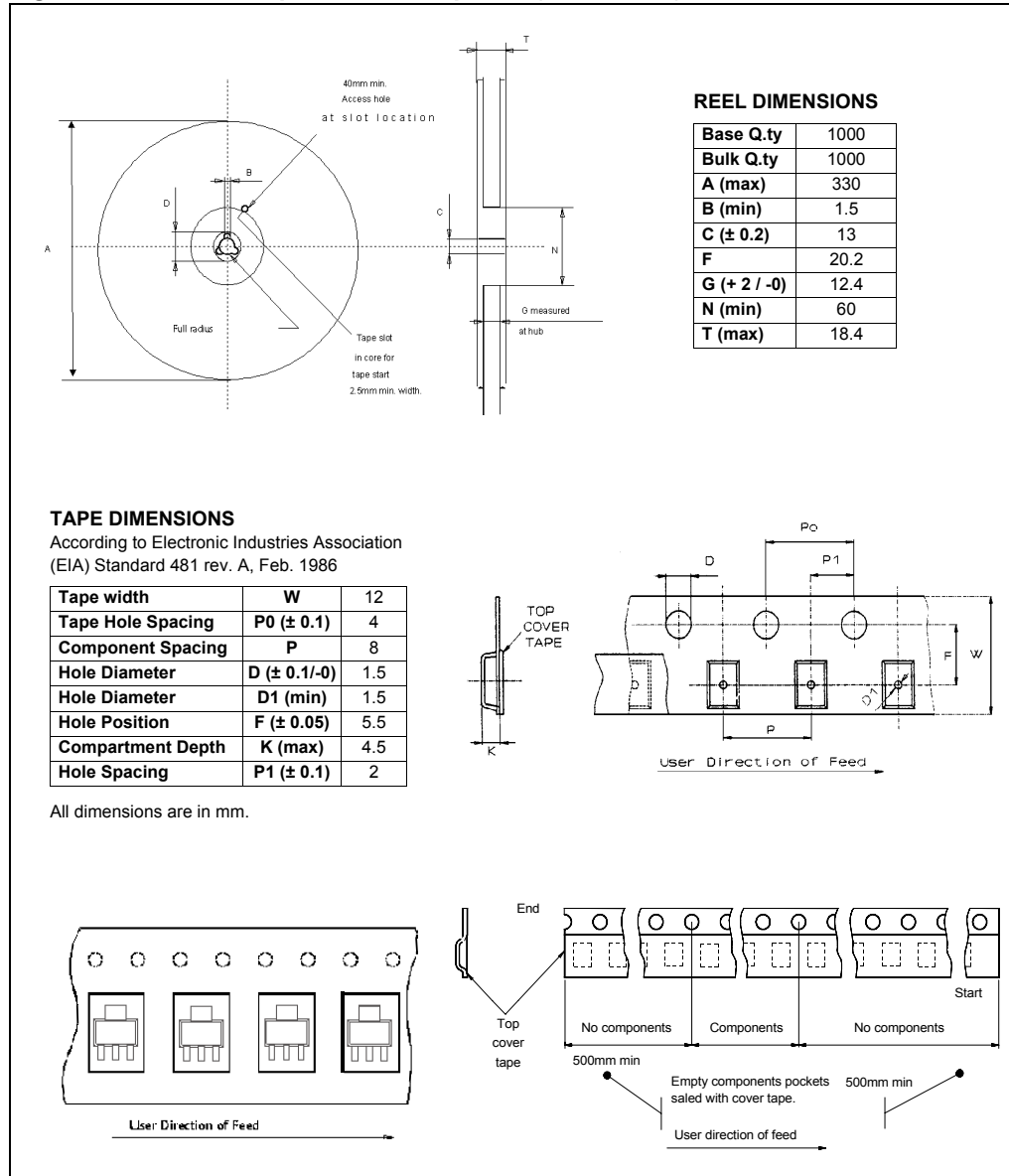

5.6 SO-8 packing information

Figure 53. SO-8 tube shipment (no suffix)

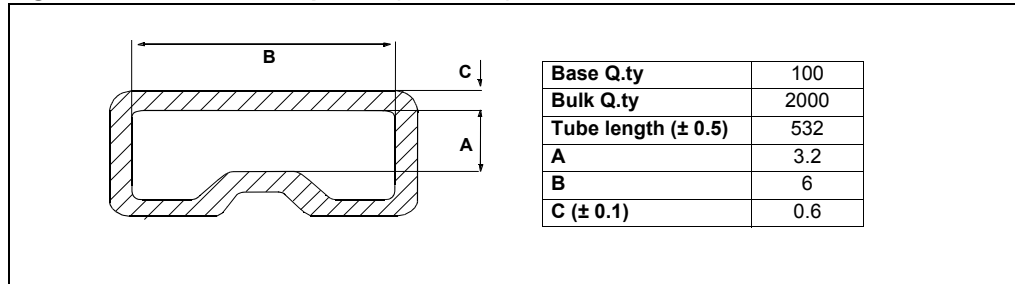
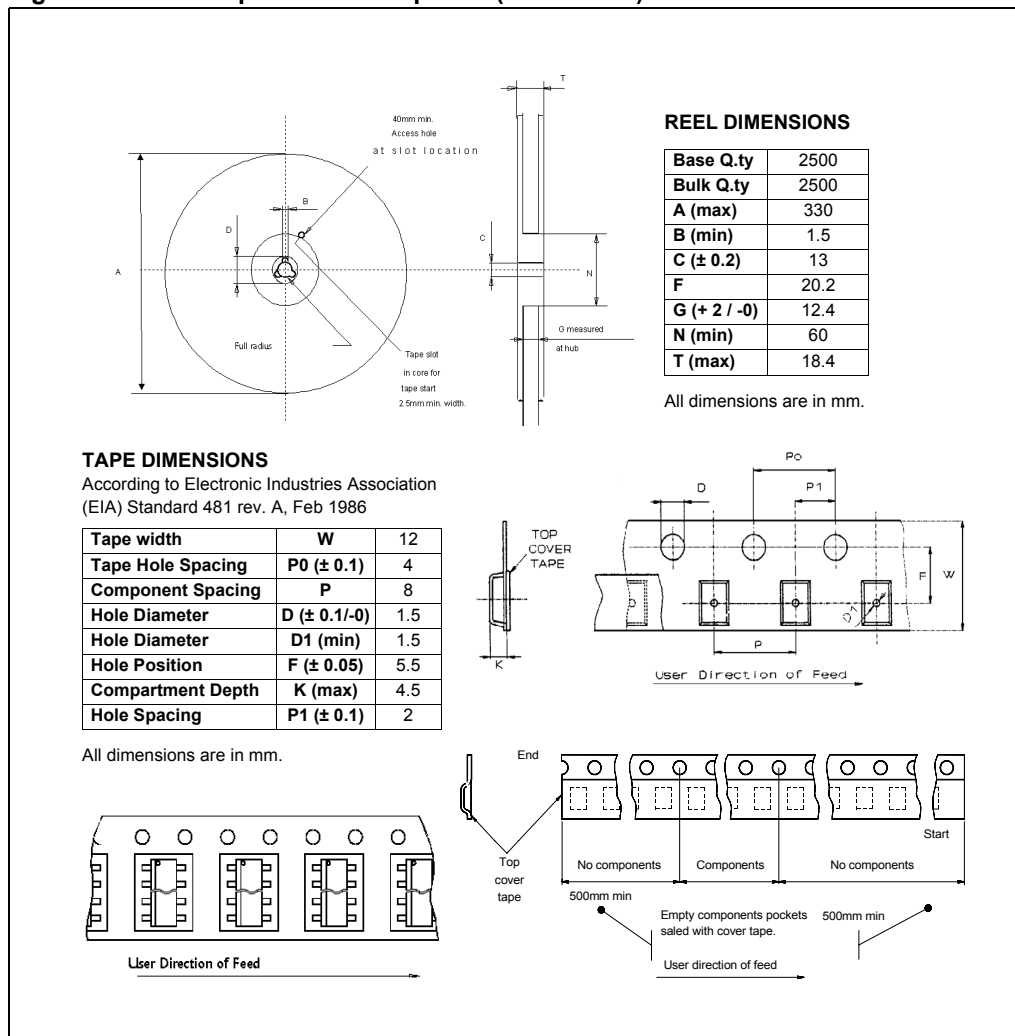

Figure 54. SO-8 tape and reel shipment (suffix "TR")



5.7 DPAK packing information

Figure 55. DPAK footprint and tube shipment (no suffix)

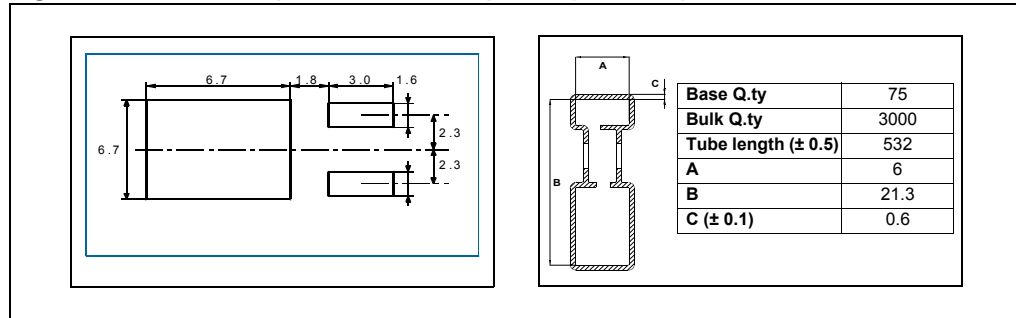
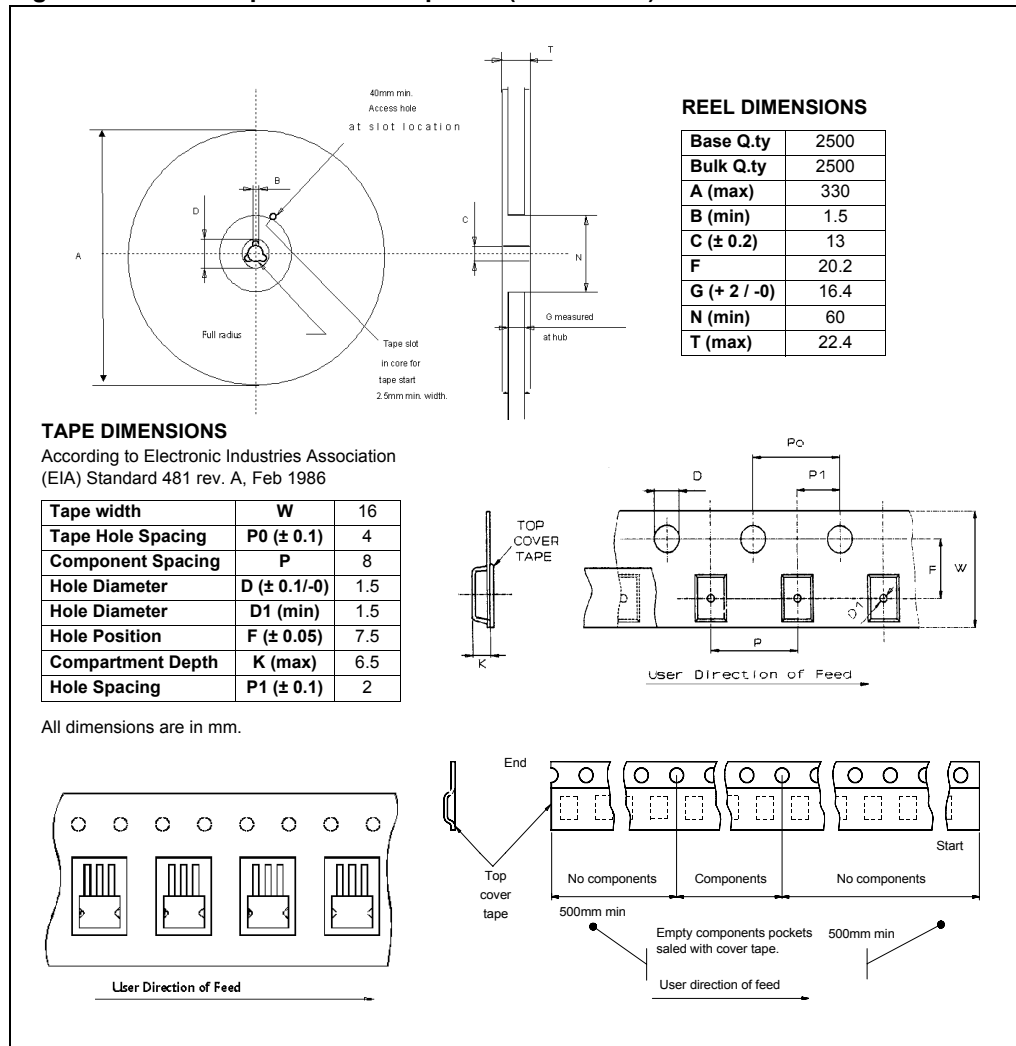
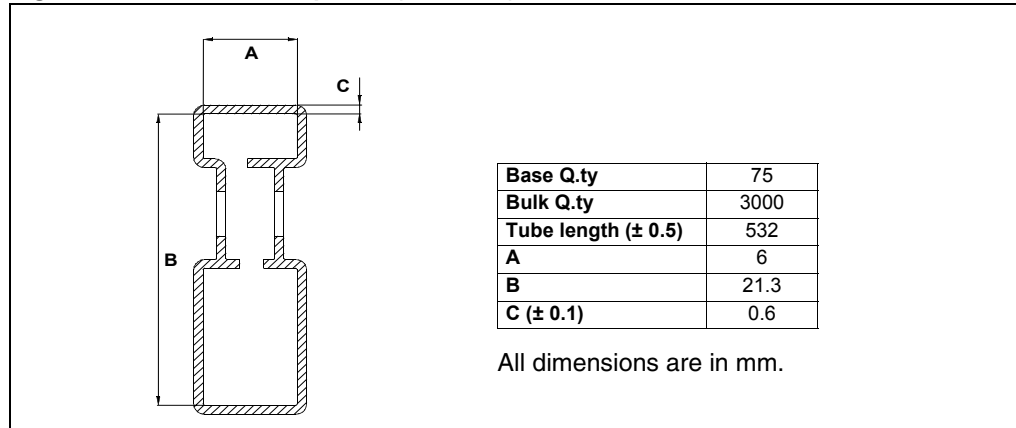

Figure 56. DPAK tape and reel shipment (suffix “TR”)



5.8 IPAK packing information

Figure 57. IPAK tube shipment (no suffix)



6 Revision history

Table 12. Document revision history

Date	Revision	Changes
01-Feb-2003	1	Initial Release
28-Apr-2009	2	Added Table 1: Device summary on page 1 and Section 4: Package and PCB thermal data on page 20 . Updated Section 5: Package and packing information on page 27 .
10-Sep-2010	3	Updated Table 4: Electrical characteristics

Please Read Carefully:

Information in this document is provided solely in connection with ST products. STMicroelectronics NV and its subsidiaries ("ST") reserve the right to make changes, corrections, modifications or improvements, to this document, and the products and services described herein at any time, without notice.

All ST products are sold pursuant to ST's terms and conditions of sale.

Purchasers are solely responsible for the choice, selection and use of the ST products and services described herein, and ST assumes no liability whatsoever relating to the choice, selection or use of the ST products and services described herein.

No license, express or implied, by estoppel or otherwise, to any intellectual property rights is granted under this document. If any part of this document refers to any third party products or services it shall not be deemed a license grant by ST for the use of such third party products or services, or any intellectual property contained therein or considered as a warranty covering the use in any manner whatsoever of such third party products or services or any intellectual property contained therein.

UNLESS OTHERWISE SET FORTH IN ST'S TERMS AND CONDITIONS OF SALE ST DISCLAIMS ANY EXPRESS OR IMPLIED WARRANTY WITH RESPECT TO THE USE AND/OR SALE OF ST PRODUCTS INCLUDING WITHOUT LIMITATION IMPLIED WARRANTIES OF MERCHANTABILITY, FITNESS FOR A PARTICULAR PURPOSE (AND THEIR EQUIVALENTS UNDER THE LAWS OF ANY JURISDICTION), OR INFRINGEMENT OF ANY PATENT, COPYRIGHT OR OTHER INTELLECTUAL PROPERTY RIGHT.

UNLESS EXPRESSLY APPROVED IN WRITING BY AN AUTHORIZED ST REPRESENTATIVE, ST PRODUCTS ARE NOT RECOMMENDED, AUTHORIZED OR WARRANTED FOR USE IN MILITARY, AIR CRAFT, SPACE, LIFE SAVING, OR LIFE SUSTAINING APPLICATIONS, NOR IN PRODUCTS OR SYSTEMS WHERE FAILURE OR MALFUNCTION MAY RESULT IN PERSONAL INJURY, DEATH, OR SEVERE PROPERTY OR ENVIRONMENTAL DAMAGE. ST PRODUCTS WHICH ARE NOT SPECIFIED AS "AUTOMOTIVE GRADE" MAY ONLY BE USED IN AUTOMOTIVE APPLICATIONS AT USER'S OWN RISK.

Resale of ST products with provisions different from the statements and/or technical features set forth in this document shall immediately void any warranty granted by ST for the ST product or service described herein and shall not create or extend in any manner whatsoever, any liability of ST.

ST and the ST logo are trademarks or registered trademarks of ST in various countries.

Information in this document supersedes and replaces all information previously supplied.

The ST logo is a registered trademark of STMicroelectronics. All other names are the property of their respective owners.

© 2010 STMicroelectronics - All rights reserved

STMicroelectronics group of companies

Australia - Belgium - Brazil - Canada - China - Czech Republic - Finland - France - Germany - Hong Kong - India - Israel - Italy - Japan - Malaysia - Malta - Morocco - Philippines - Singapore - Spain - Sweden - Switzerland - United Kingdom - United States of America

www.st.com

