

# FPF2108-FPF2110 IntelliMAX™ Advanced Load Management Products

## Features

- 1.8 to 5.5V Input Voltage Range
- Controlled Turn-On
- 200mA and 400mA Current Limit Options
- Undervoltage Lockout
- Thermal Shutdown
- <math>2\mu\text{A}</math> Shutdown Current
- Fast Current limit Response Time
  - 3 $\mu\text{s}$  to Moderate Over Currents
  - 20ns to Hard Shorts
- Reverse Current Blocking
- Fault Blanking
- RoHS Compliant

## Applications

- PDAs
- Cell Phones
- GPS Devices
- MP3 Players
- Digital Cameras
- Peripheral Ports
- Hot Swap Supplies



## General Description

The FPF2108-FPF2110 is a series of load switches which provides full protection to systems and loads which may encounter large current conditions. This devices contain a 0.125 $\Omega$  current-limited P-channel MOSFET which can operate over an input voltage range of 1.8-5.5V. Internally, reverse current blocking prevents current from flowing when the MOSFET is off and the output voltage is higher than the input voltage. Switch control is by a logic input (ON) capable of interfacing directly with low voltage control signals. Each part contains thermal shutdown protection which shuts off the switch to prevent damage to the part when a continuous over-current condition causes excessive heating.

When the switch current reaches the current limit, the part operates in a constant-current mode to prohibit excessive currents from causing damage. For the FPF2108, if the constant current condition still persists after 10ms, the part will shut off the switch and pull the fault signal pin (FLAGB) low. The switch will remain off until the ON pin is cycled. For the FPF2109 and FPF2110, a current limit condition will immediately pull the fault signal pin low and the part will remain in the constant-current mode until the switch current falls below the current limit. The minimum current limit is 200mA for the FPF2109 while that for the FPF2108 and FPF2110 is 400mA.

These parts are available in a space-saving 5 pin SOT23 package.

## Typical Application Circuit

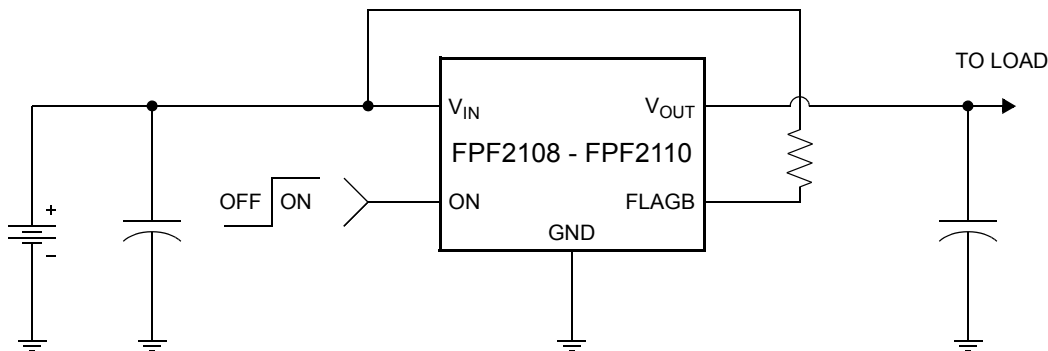

## Ordering Information

Part	Current Limit [mA]	Current Limit Blanking Time [ms]	Auto-Restart Time [ms]	ON Pin Activity	Top Mark
FPF2108	400	10	NA	Active LO	2108
FPF2109	200	0	NA	Active HI	2109
FPF2110	400	0	NA	Active HI	2110

### Functional Block Diagram

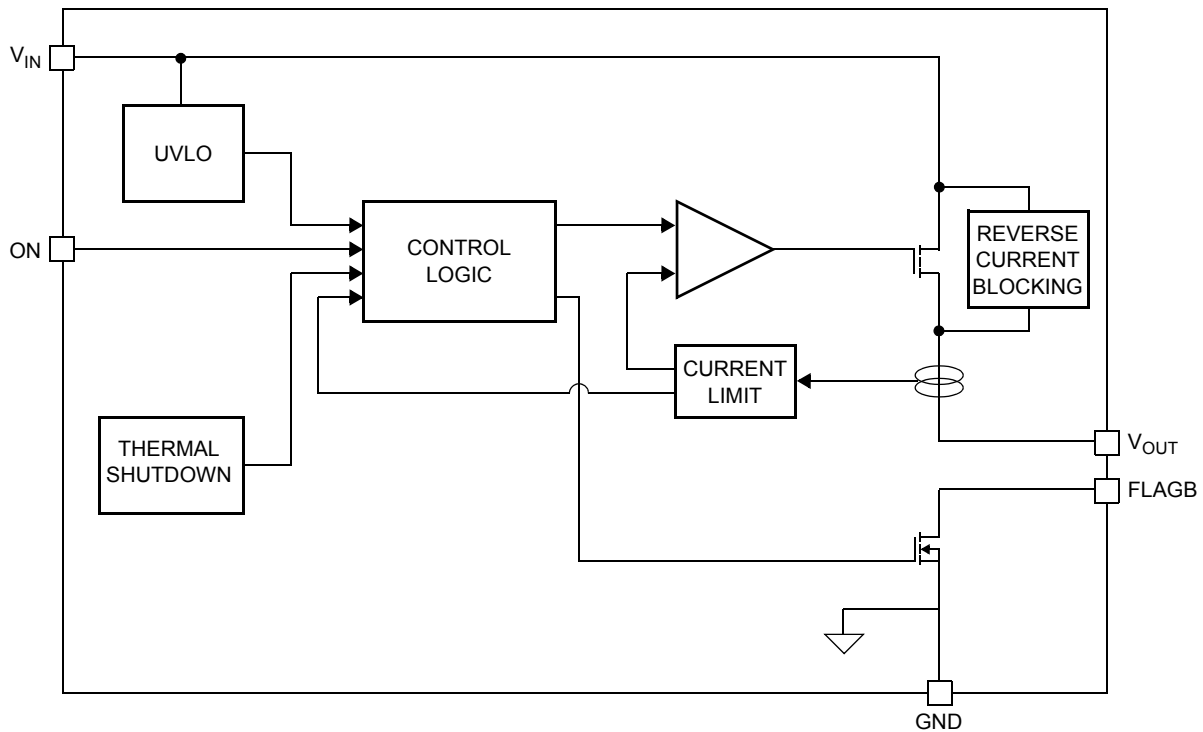

### Pin Configuration

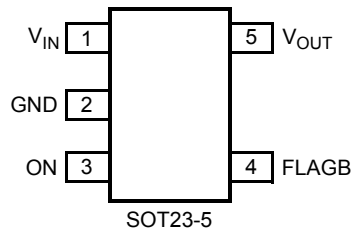

### Pin Description

Pin	Name	Function
1	$V_{IN}$	Supply Input: Input to the power switch and the supply voltage for the IC
2	GND	Ground
3	ON	ON Control Input
4	FLAGB	Fault Output: Active LO, open drain output which indicates an over current supply, under voltage or over temperature state.
5	$V_{OUT}$	Switch Output: Output of the power switch

## Absolute Maximum Ratings

Parameter		Min.	Max.	Unit
$V_{IN}$ , $V_{OUT}$ , ON, FLAGB to GND		-0.3	6	V
Power Dissipation @ $T_A = 25^\circ\text{C}$ (note 1)			667	mW
Operating Temperature Range		-40	125	$^\circ\text{C}$
Storage Temperature		-65	150	$^\circ\text{C}$
Thermal Resistance, Junction to Ambient			150	$^\circ\text{C}/\text{W}$
Electrostatic Discharge Protection	HBM	4000		V
	MM	400		V

## Recommended Operating Range

Parameter		Min	Max	Unit
$V_{IN}$		1.8	5.5	V
Ambient Operating Temperature, $T_A$		-40	85	$^\circ\text{C}$

## Electrical Characteristics

$V_{IN} = 1.8$  to  $5.5\text{V}$ ,  $T_A = -40$  to  $+85^\circ\text{C}$  unless otherwise noted. Typical values are at  $V_{IN} = 3.3\text{V}$  and  $T_A = 25^\circ\text{C}$ .

Parameter	Symbol	Conditions	Min	Typ	Max	Units	
<b>Basic Operation</b>							
Operating Voltage	$V_{IN}$		1.8		5.5	V	
Quiescent Current	$I_Q$	$I_{OUT} = 0\text{mA}$		95		$\mu\text{A}$	
		Von active	$V_{IN} = 1.8$ to $3.3\text{V}$ $V_{IN} = 3.3$ to $5.5\text{V}$		110 200		
Shutdown Current	$I_{SHDN}$				2	$\mu\text{A}$	
Reverse Block Leakage Current	$I_{BLOCK}$				1	$\mu\text{A}$	
Latch-Off Current (note 2)	$I_{LATCHOFF}$	$V_{ON} = V_{IN}$ , after an overcurrent fault		50		$\mu\text{A}$	
On-Resistance	$R_{ON}$	$V_{IN} = 3.3\text{V}$ , $I_{OUT} = 50\text{mA}$ , $T_A = 25^\circ\text{C}$		125	160	m $\Omega$	
		$V_{IN} = 3.3\text{V}$ , $I_{OUT} = 50\text{mA}$ , $T_A = 85^\circ\text{C}$		150	200		
		$V_{IN} = 3.3\text{V}$ , $I_{OUT} = 50\text{mA}$ , $T_A = -40^\circ\text{C}$ to $+85^\circ\text{C}$	65		200		
ON Input Logic High Voltage	$V_{IH}$	$V_{IN} = 1.8\text{V}$	0.75			V	
		$V_{IN} = 5.5\text{V}$	1.30				
ON Input Logic Low Voltage	$V_{IL}$	$V_{IN} = 1.8\text{V}$			0.5	V	
		$V_{IN} = 5.5\text{V}$			1.0		
ON Input Leakage		$V_{ON} = V_{IN}$ or GND			1	$\mu\text{A}$	
Off Switch Leakage	$I_{SWOFF}$	$V_{ON} = 0\text{V}$ , $V_{OUT} = 0\text{V}$			1	$\mu\text{A}$	
FLAGB Output Logic Low Voltage		$V_{IN} = 5\text{V}$ , $I_{SINK} = 10\text{mA}$		0.1	0.2	V	
		$V_{IN} = 1.8\text{V}$ , $I_{SINK} = 10\text{mA}$		0.15	0.3		
FLAGB Output High Leakage Current		$V_{IN} = 5\text{V}$ , Switch on			1	$\mu\text{A}$	
<b>Protections</b>							
Current Limit	$I_{LIM}$	$V_{IN} = 3.3\text{V}$ , $V_{OUT} = 3.0\text{V}$	FPF2109	200	300	400	mA
			FPF2108, FPF2110	400	600	800	
Thermal Shutdown			Shutdown Threshold		140		$^\circ\text{C}$
			Return from Shutdown		130		
			Hysteresis		10		
Under Voltage Shutdown	UVLO	$V_{IN}$ Increasing	1.5	1.6	1.7	V	
Under Voltage Shutdown Hysteresis				47		mV	

## Electrical Characteristics Cont.

$V_{IN} = 1.8$  to  $5.5V$ ,  $T_A = -40$  to  $+85^{\circ}C$  unless otherwise noted. Typical values are at  $V_{IN} = 3.3V$  and  $T_A = 25^{\circ}C$ .

Parameter	Symbol	Conditions	Min.	Typ.	Max	Units
<b>Dynamic</b>						
Turn on time	$t_{ON}$	$R_L = 500\Omega$ , $C_L = 0.1\mu F$		25		$\mu s$
Turn off time	$t_{OFF}$	$R_L = 500\Omega$ , $C_L = 0.1\mu F$		50		$\mu s$
$V_{OUT}$ Rise Time	$t_R$	$R_L = 500\Omega$ , $C_L = 0.1\mu F$		12		$\mu s$
$V_{OUT}$ Fall Time	$t_F$	$R_L = 500\Omega$ , $C_L = 0.1\mu F$		136		$\mu s$
Over Current Blanking Time	$t_{BLANK}$	FPF2108	5	10	20	ms
Short Circuit Response Time		$V_{IN} = V_{ON} = 3.3V$ . Moderate Over-Current Condition.		3		$\mu s$
		$V_{IN} = V_{ON} = 3.3V$ . Hard Short.		20		ns

**Note 1:** Package power dissipation on 1square inch pad, 2 oz copper board.

**Note 2:** Applicable only to FPF2108. Latchoff current does not include current flowing into FLAGB.

## Typical Characteristics

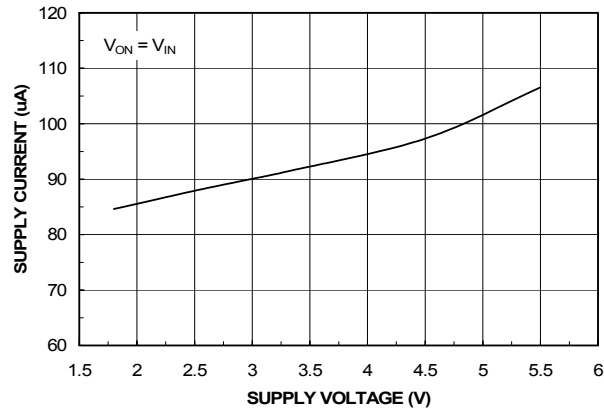

Figure 1. Quiescent Current vs. Input Voltage

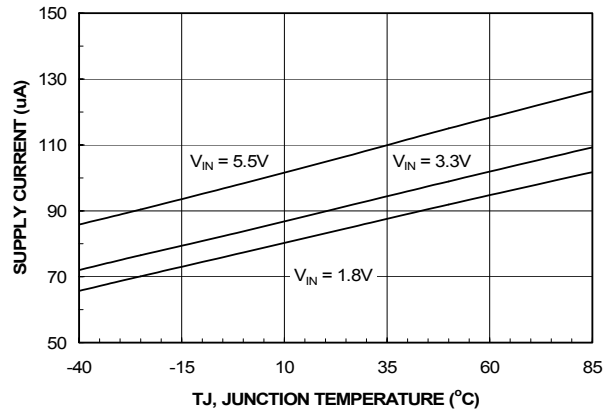

Figure 2. Quiescent Current vs. Temperature

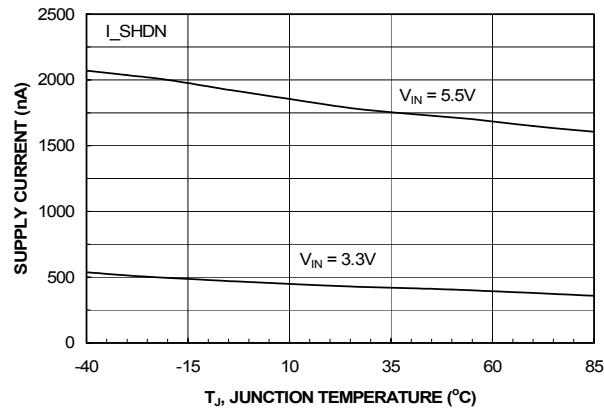

Figure 3.  $I_{SHUTDOWN}$  Current vs. Temperature

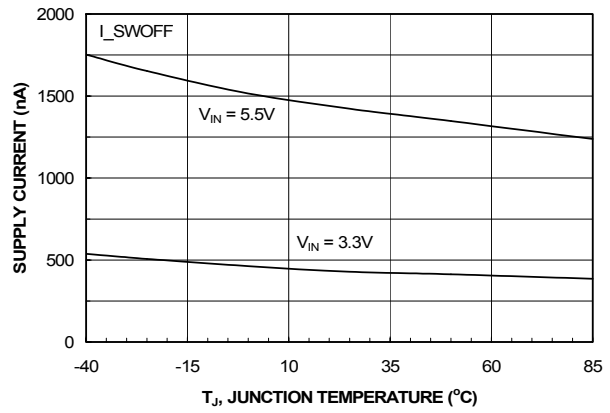

Figure 4.  $I_{SWITCH-OFF}$  Current vs. Temperature

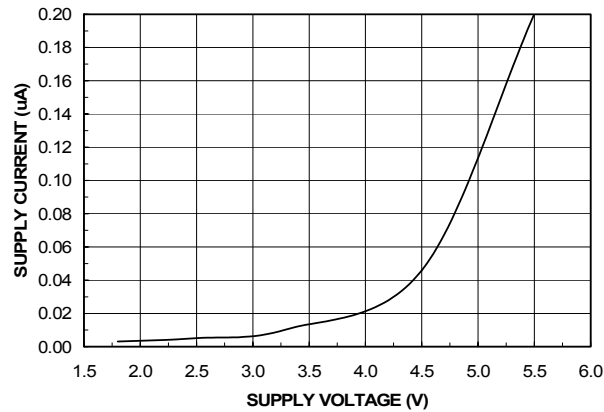

Figure 5. Reverse Current vs.  $V_{OUT}$

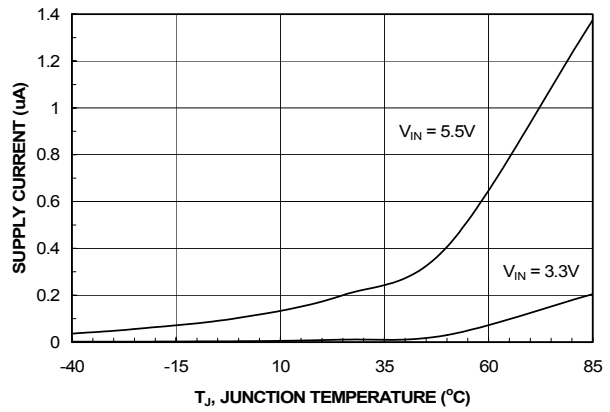

Figure 6. Reverse Current vs. Temperature

### Typical Characteristics

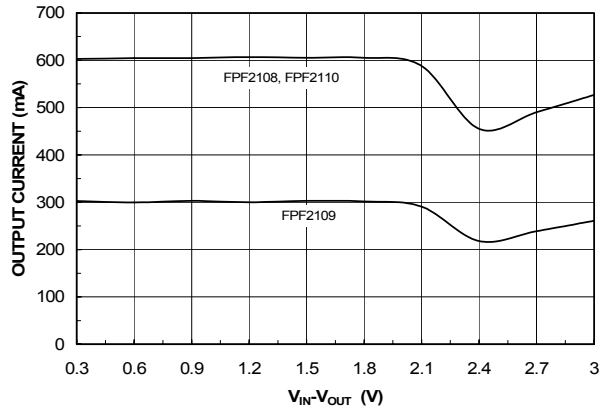

Figure 7. Current Limit vs. Output Voltage

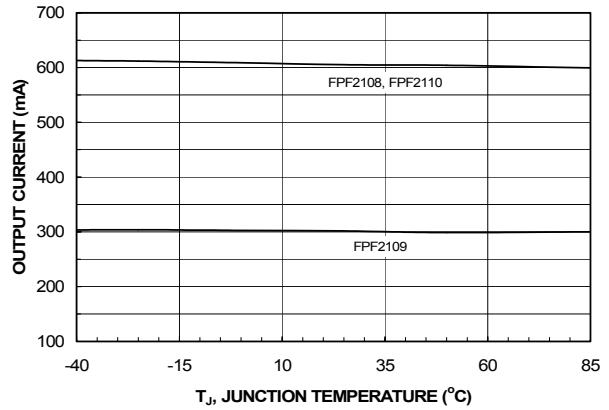

Figure 8. Current Limit vs. Temperature

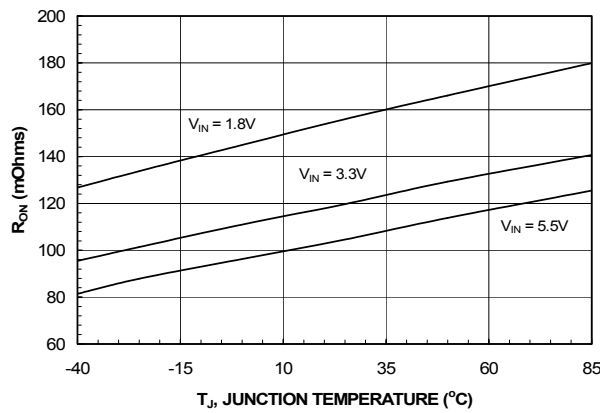

Figure 9.  $R_{ON}$  vs. Temperature

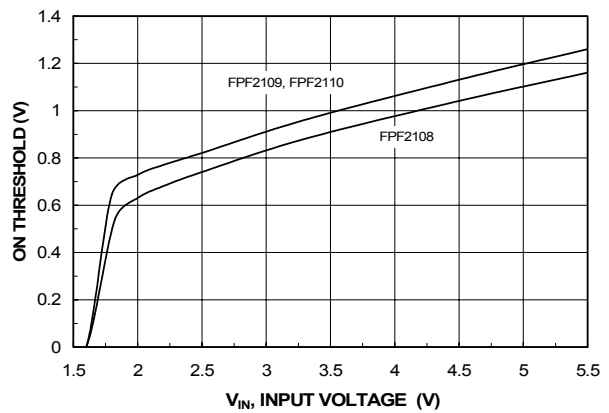

Figure 10.  $V_{IH}$  vs.  $V_{IN}$

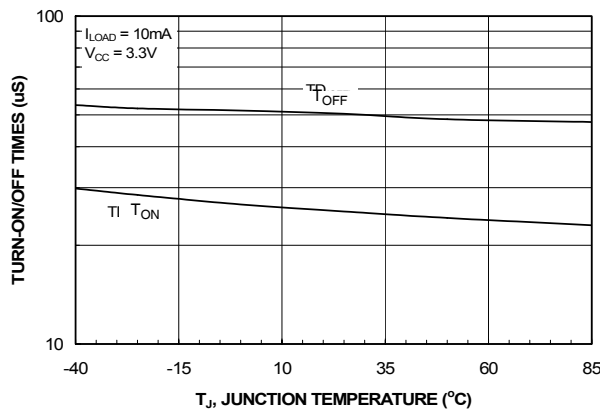

Figure 11.  $T_{ON}/T_{OFF}$  vs. Temperature

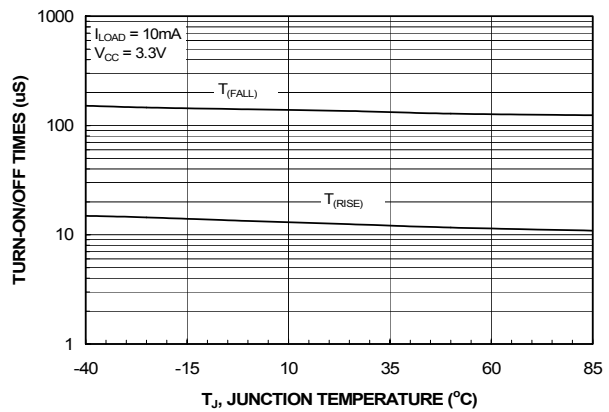

Figure 12.  $T_{RISE}/T_{FALL}$  vs. Temperature

## Typical Characteristics

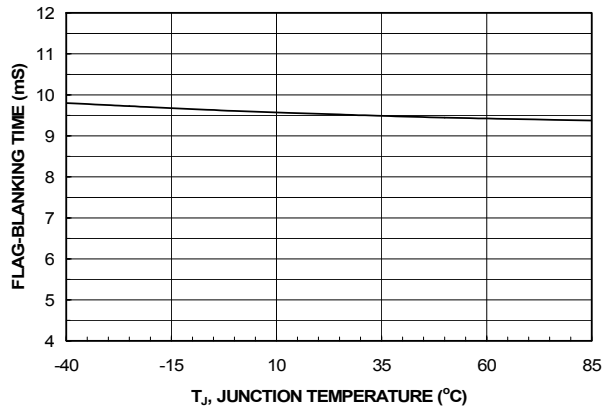

Figure 13.  $T_{BLANK}$  vs. Temperature

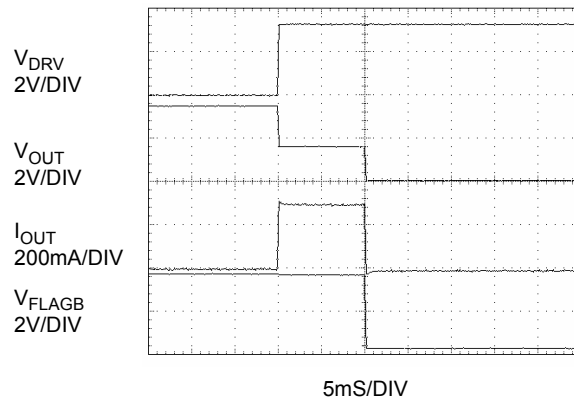

Figure 14.  $T_{BLANK}$  Response  
( $V_{DRV}$  signal forces the device to go into overcurrent condition.)

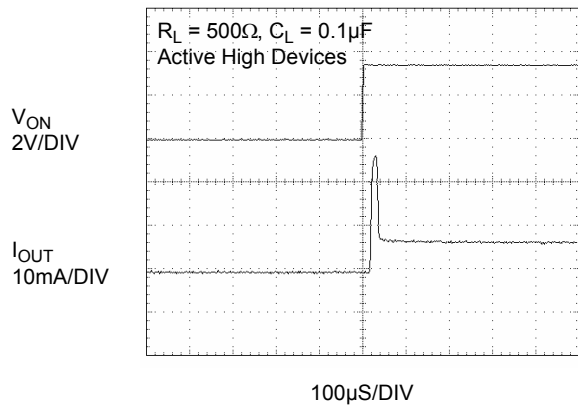

Figure 15.  $T_{ON}$  Response

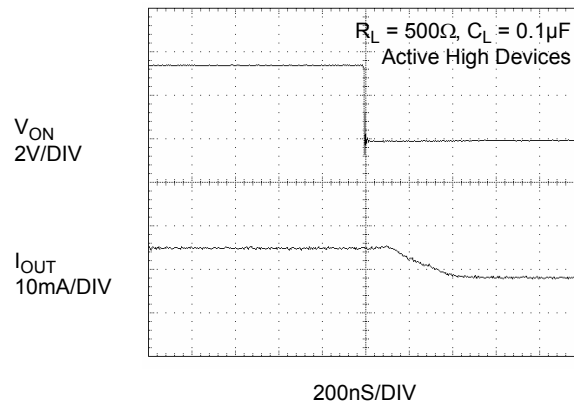

Figure 16.  $T_{OFF}$  Response

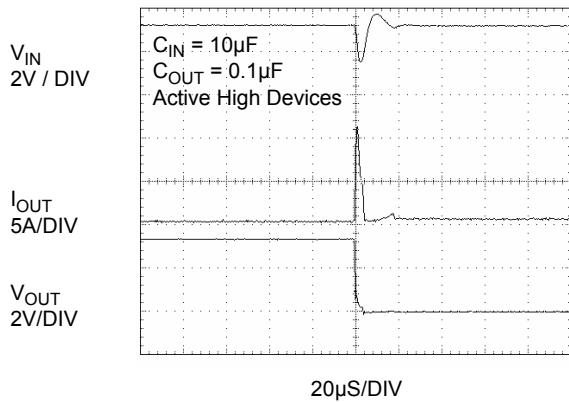

Figure 17. Short Circuit Response Time  
(Output Shorted to GND)

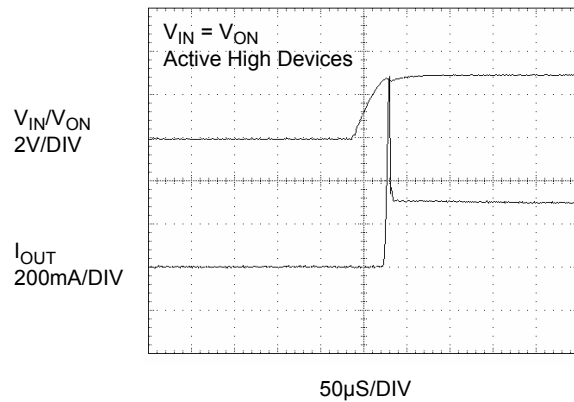

Figure 18. Current Limit Response  
(Switch power up to hard short)

### Typical Characteristics

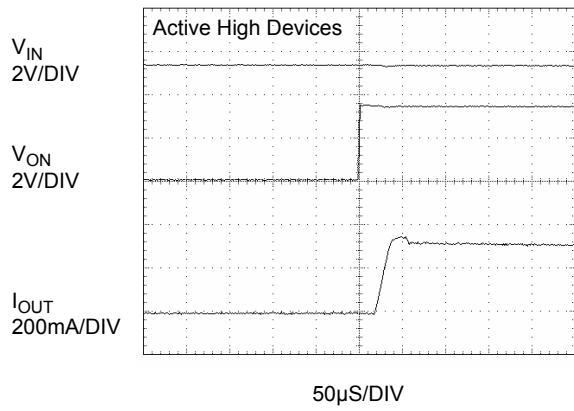

Figure 19. Current Limit Response Time  
(Output Shorted to GND by 10Ω, moderate short)



## Description of Operation

The FPF2108-FPF2110 is a current limited switch that protects systems and loads which can be damaged or disrupted by the application of high currents. The core of the device is a  $0.125\Omega$  P-channel MOSFET and a controller capable of functioning over a wide input operating range of 1.8-5.5V. The controller protects against system malfunctions through current limiting, under-voltage lockout and thermal shutdown. The current limit is preset for either 200mA or 400mA.

### On/OffControl

The ON pin controls the state of the switch. Active HI and LO versions are available. Refer to the Ordering Information for details. Activating ON continuously holds the switch in the on state so long as there is no fault. For all versions, an under-voltage on  $V_{IN}$  or a junction temperature in excess of  $150^{\circ}\text{C}$  overrides the ON control to turn off the switch. For FPF2108, the ON pin must be toggled to turn on the switch again. The FPF2109 and FPF2110 do not turn off in response to a over current condition but instead remain operating in a constant current mode so long as ON is active and the thermal shutdown or under-voltage lockout have not activated. When the MOSFET is off, the body diode is disabled so no current can flow through it.

### Fault Reporting

Upon the detection of an over-current, an input under-voltage, or an over-temperature condition, the FLAGB signals the fault mode by activating LO. For the FPF2108, the FLAGB goes LO at the end of the blanking time while FLAGB goes LO immediately for the FPF2109 and FPF2110. For the FPF2108, FLAGB is latched LO and ON must be toggled to release it. With the FPF2109 and FPF2110, FLAGB is LO during the faults and immediately returns HI at the end of the fault condition. FLAGB is an open-drain MOSFET which requires a pull-up resistor between  $V_{IN}$  and FLAGB. During shutdown, the pull-down on FLAGB is disabled to reduce current draw from the supply.

### Current Limiting

The current limit ensures that the current through the switch doesn't exceed a maximum value while not limiting at less than a minimum value. For the FPF2109 the minimum current is 200mA and the maximum current is 400mA and for the FPF2108 and FPF2110 the minimum current is 400mA and the maximum current is 800mA. The FPF2108 has a blanking time of 10ms, nominally, during which the switch will act as a constant current source. At the end of the blanking time, the switch will be turned-off and the FLAGB pin will activate to indicate that current limiting has occurred. The FPF2109 and FPF2110 have no current limit blanking period so immediately upon a current limit condition FLAGB is activated. These parts will remain in a constant current state until the ON pin is deactivated or the thermal shutdown turns-off the switch.

### Under-Voltage Lockout

The under-voltage lockout turns-off the switch if the input voltage drops below the under-voltage lockout threshold. With the ON pin active the input voltage rising above the under-voltage lockout threshold will cause a controlled turn on of the switch which limits current over-shoots.

### Thermal Shutdown

The thermal shutdown protects the part from internally or externally generated excessive temperatures. During an over-temperature condition the FLAGB is activated and the switch is turned-off. The switch automatically turns-on again if the temperature of the die drops below the threshold temperature.

## Application Information

### Typical Application

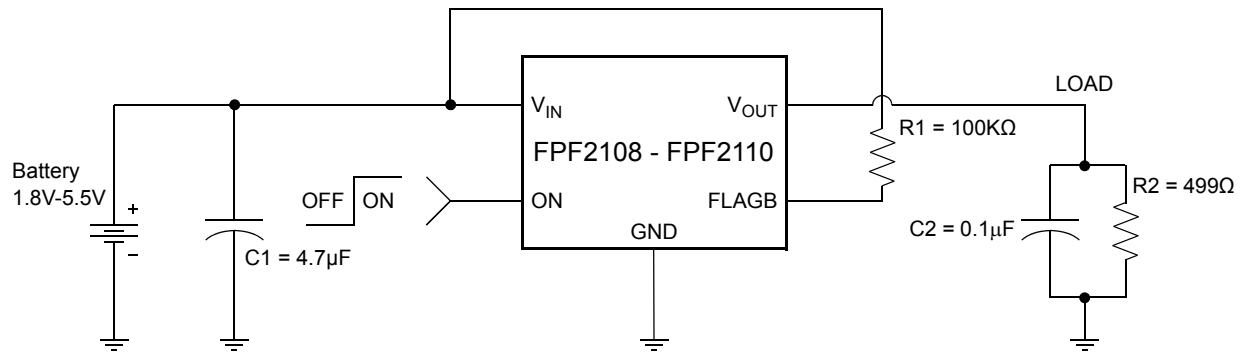

### Input Capacitor

To limit the voltage drop on the input supply caused by transient in-rush currents when the switch turns-on into a discharged load capacitor or a short-circuit, a capacitor needs to be placed between  $V_{IN}$  and GND. A  $4.7\mu\text{F}$  ceramic capacitor,  $C_{IN}$ , must be placed close to the  $V_{IN}$  pin. A higher value of  $C_{IN}$  can be used to further reduce the voltage drop experienced as the switch is turned on into a large capacitive load.

### Output Capacitor

A  $0.1\mu\text{F}$  capacitor  $C_{OUT}$  should be placed between  $V_{OUT}$  and GND. This capacitor will prevent parasitic board inductances from forcing  $V_{OUT}$  below GND when the switch turns-off.

### Power Dissipation

During normal operation as a switch, the power dissipation is small and has little effect on the operating temperature of the part. The parts with the higher current limits will dissipate the

$$P = (I_{LM})^2 * R_{DS} = (0.8)^2 * 0.125 = 80\text{mW}$$

most power and that will only typically be,

When in current limit the maximum power dissipation will occur when the output is shorted to ground. A short on the output will cause the part to operate in a constant current state until the thermal shutdown activates. It will then cycle in and out of thermal shutdown so long as the ON pin is active and the short is present.

### Board Layout

For best performance, all traces should be as short as possible. To be most effective, the input and output capacitors should be placed close to the device to minimize the effects that parasitic trace inductances may have on normal and short-circuit operation. Using wide traces for  $V_{IN}$ ,  $V_{OUT}$  and GND will help minimize parasitic electrical effects along with minimizing the case to ambient thermal impedance.

# Dimensional Outline and Pad Layout



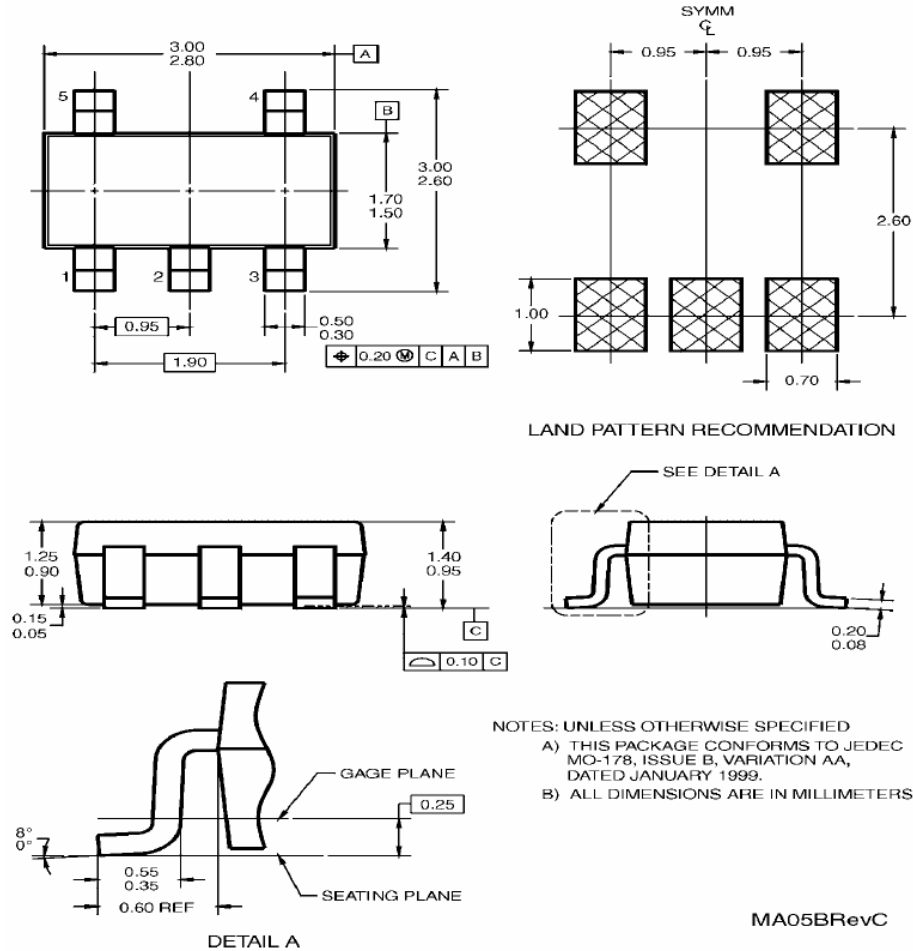

## Package MA05B





**TRADEMARKS**

The following includes registered and unregistered trademarks and service marks, owned by Fairchild Semiconductor and/or its global subsidiaries, and is not intended to be an exhaustive list of all such trademarks.

- |   |   |   |   |
|---|---|---|---|
| Build it Now™   | FPS™  | PDP SPM™  | The Power Franchise®  |
| CorePLUS™   | F-PFS™  | Power-SPM™  | the   |
| CorePOWER™  | FRFET®  | PowerTrench®  | <b>power</b>  |
| CROSSVOLT™  | Global Power ResourceSM   | Programmable Active Droop™  | franchise   |
| CTL™  | Green FPS™  | QFET®   | TinyBoost™  |
| Current Transfer Logic™   | Green FPS™ e-Series™  | QS™   | TinyBuck™   |
| EcoSPARK®   | GTO™  | Quiet Series™   | TinyLogic®  |
| EfficientMax™   | IntelliMAX™   | RapidConfigure™   | TINYOPTO™   |
| EZSWITCH™ *   | ISOPLANAR™  | Saving our world, 1mW at a time™  | TinyPower™  |
|  | MegaBuck™   | SmartMax™   | TinyPWM™  |
|  | MICROCOUPLER™   | SMART START™  | TinyWire™   |
| Fairchild®  | MicroFET™   | SPM®  | µSerDes™  |
| Fairchild Semiconductor®  | MicroPak™   | STEALTH™  |  |
| FACT Quiet Series™  | MillerDrive™  | SuperFET™   | UHC®  |
| FACT®   | MotionMax™  | SuperSOT™-3   | Ultra FRFET™  |
| FAST®   | Motion-SPM™   | SuperSOT™-6   | UniFET™   |
| FastvCore™  | OPTOLOGIC®  | SuperSOT™-8   | VCX™  |
| FlashWriter® *  | OPTOPLANAR®   | SupreMOS™   | VisualMax™  |
|   |  | SyncFET™  |   |
|   |   |  |   |

\* EZSWITCH™ and FlashWriter® are trademarks of System General Corporation, used under license by Fairchild Semiconductor.

**DISCLAIMER**

FAIRCHILD SEMICONDUCTOR RESERVES THE RIGHT TO MAKE CHANGES WITHOUT FURTHER NOTICE TO ANY PRODUCTS HEREIN TO IMPROVE RELIABILITY, FUNCTION, OR DESIGN. FAIRCHILD DOES NOT ASSUME ANY LIABILITY ARISING OUT OF THE APPLICATION OR USE OF ANY PRODUCT OR CIRCUIT DESCRIBED HEREIN; NEITHER DOES IT CONVEY ANY LICENSE UNDER ITS PATENT RIGHTS, NOR THE RIGHTS OF OTHERS. THESE SPECIFICATIONS DO NOT EXPAND THE TERMS OF FAIRCHILD'S WORLDWIDE TERMS AND CONDITIONS, SPECIFICALLY THE WARRANTY THEREIN, WHICH COVERS THESE PRODUCTS.

**LIFE SUPPORT POLICY**

FAIRCHILD'S PRODUCTS ARE NOT AUTHORIZED FOR USE AS CRITICAL COMPONENTS IN LIFE SUPPORT DEVICES OR SYSTEMS WITHOUT THE EXPRESS WRITTEN APPROVAL OF FAIRCHILD SEMICONDUCTOR CORPORATION.

As used herein:

- Life support devices or systems are devices or systems which, (a) are intended for surgical implant into the body or (b) support or sustain life, and (c) whose failure to perform when properly used in accordance with instructions for use provided in the labeling, can be reasonably expected to result in a significant injury of the user.
- A critical component in any component of a life support, device, or system whose failure to perform can be reasonably expected to cause the failure of the life support device or system, or to affect its safety or effectiveness.

**ANTI-COUNTERFEITING POLICY**

Fairchild Semiconductor Corporation's Anti-Counterfeiting Policy. Fairchild's Anti-Counterfeiting Policy is also stated on our external website, [www.fairchildsemi.com](http://www.fairchildsemi.com), under Sales Support.

Counterfeiting of semiconductor parts is a growing problem in the industry. All manufacturers of semiconductor products are experiencing counterfeiting of their parts. Customers who inadvertently purchase counterfeit parts experience many problems such as loss of brand reputation, substandard performance, failed application, and increased cost of production and manufacturing delays. Fairchild is taking strong measures to protect ourselves and our customers from the proliferation of counterfeit parts. Fairchild strongly encourages customers to purchase Fairchild parts either directly from Fairchild or from Authorized Fairchild Distributors who are listed by country on our web page cited above. Products customers buy either from fairchild directly or from Authorized Fairchild Distributors are genuine parts, have full traceability, meet Fairchild's quality standards for handling and storage and provide access to Fairchild's full range of up-to-date technical and product information. Fairchild and our Authorized Distributors will stand behind all warranties and will appropriately address and warranty issues that may arise. Fairchild will not provide any warranty coverage or other assistance for parts bought from Unauthorized Sources. Fairchild is committed to combat this global problem and encourage our customers to do their part in stopping this practice by buying direct or from authorized distributors.

**PRODUCT STATUS DEFINITIONS**

**Definition of Terms**

Datasheet Identification	Product Status	Definition
Advance Information	Formative / In Design	Datasheet contains the design specifications for product development. Specifications may change in any manner without notice.
Preliminary	First Production	Datasheet contains preliminary data; supplementary data will be published at a later date. Fairchild Semiconductor reserves the right to make changes at any time without notice to improve design.
No Identification Needed	Full Production	Datasheet contains final specifications. Fairchild Semiconductor reserves the right to make changes at any time without notice to improve the design.
Obsolete	Not In Production	Datasheet contains specifications on a product that is discontinued by Fairchild Semiconductor. The datasheet is for reference information only.

Rev. 135