

Three PLL General Purpose EPROM Programmable Clock Generator

Features

- Three integrated phase locked loops (PLLs)
- Erasable programmable read only memory (EPROM) programmability
- Factory programmable (CY2292) or field programmable (CY2292F) device options
- Low-skew, low-jitter, high accuracy outputs
- Power management options (shutdown, OE, suspend)
- Frequency select option
- Smooth slewing on CPUCLK
- Configurable 3.3 V or 5 V operation
- 16-pin small-outline integrated circuit (SOIC) package (CY2292F also in TSSOP)

Benefits

- Generates up to three custom frequencies from one external source
- Easy customization and fast turnaround
- Programming support available for all opportunities
- Supports low power applications
- Eight user selectable frequencies on CPU PLL
- Allows downstream PLLs to stay locked on CPUCLK output
- Industry standard packaging saves on board space

Selector Guide

Part Number	Input Frequency Range	Output Frequency Range	Specifics
CY2292SC, SL, SXC, SXL	10 MHz to 25 MHz (external crystal) 1 MHz to 30 MHz (reference clock)	76.923 kHz to 100 MHz (5 V) 76.923 kHz to 80 MHz (3.3 V)	Factory programmable Commercial temperature
CY2292SI, SXI	10 MHz to 25 MHz (external crystal) 1 MHz to 30 MHz (reference clock)	76.923 kHz to 90 MHz (5 V) 76.923 kHz to 66.6 MHz (3.3 V)	Factory programmable Industrial temperature
CY2292F, FXC, FZX	10 MHz to 25 MHz (external crystal) 1 MHz to 30 MHz (reference clock)	76.923 kHz to 90 MHz (5 V) 76.923 kHz to 66.6 MHz (3.3 V)	Field programmable Commercial temperature
CY2292FXI, FZXI	10 MHz to 25 MHz (external crystal) 1 MHz to 30 MHz (reference clock)	76.923 kHz to 80 MHz (5 V) 76.923 kHz to 60.0 MHz (3.3 V)	Field programmable Industrial temperature

Logic Block Diagram

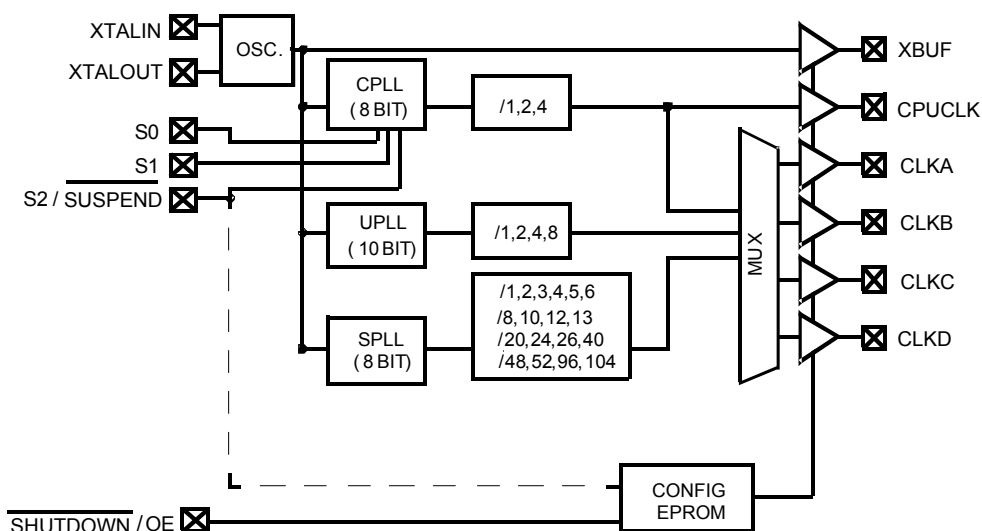

Contents

Pinouts	3	Switching Characteristics, Industrial 3.3 V	9
Pin Definitions	3	Switching Waveforms	10
Operation	4	Test Circuit	11
Output Configuration	4	Ordering Information	11
Power Saving Features	4	Possible Configurations	11
CyClocks Software	4	Ordering Code Definition	12
Cypress FTG Programmer	4	Package Characteristics	12
Custom Configuration Request Procedure	4	Package Diagrams	13
Maximum Ratings	5	Acronyms	14
Operating Conditions	5	Document Conventions	14
Electrical Characteristics, Commercial 5.0 V	5	Units of Measure	14
Electrical Characteristics, Commercial 3.3 V	5	Document History Page	15
Electrical Characteristics, Industrial 5.0 V	6	Sales, Solutions, and Legal Information	16
Electrical Characteristics, Industrial 3.3 V	6	Worldwide Sales and Design Support	16
Switching Characteristics, Commercial 5.0 V	7	Products	16
Switching Characteristics, Commercial 3.3 V	7	PSoC® Solutions	16
Switching Characteristics, Industrial 5.0 V	8		

Pinouts

Figure 1. CY2292 – 16-Pin SOIC and TSSOP

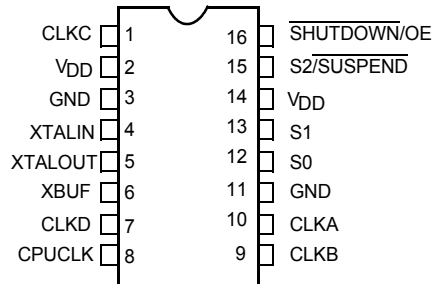

Pin Definitions

Name	Pin Number CY2292	Description
CLKC	1	Configurable clock output C.
V _{DD}	2, 14	Voltage supply.
GND	3, 11	Ground.
XTALIN ^[1]	4	Reference crystal input or external reference clock input.
XTALOUT ^[1, 2]	5	Reference crystal feedback.
XBUF	6	Buffered reference clock output.
CLKD	7	Configurable clock output D.
CPUCLK	8	CPU frequency clock output.
CLKB	9	Configurable clock output B.
CLKA	10	Configurable clock output A.
S0	12	CPU clock select input, bit 0.
S1	13	CPU clock select input, bit 1.
S2/SUSPEND	15	CPU clock select input, bit 2. Optionally enables suspend feature when LOW. ^[3]
SHUTDOWN/OE	16	Places outputs in tristate ^[4] condition and shuts down chip when LOW. Optionally, only places outputs in tristate ^[4] condition and does not shut down chip when LOW.

Notes

1. For best accuracy, use a parallel-resonant crystal, C_{LOAD} ≈ 17 pF or 18 pF.
2. Float XTALOUT pin if XTALIN is driven by reference clock (as opposed to crystal).
3. Refer to application note [Understanding the CY2291 and CY2292](#) for more information.
4. The CY2292 has weak pull downs on all outputs. Hence, when a tristate condition is forced on the outputs, the output pins are pulled low.

Operation

The CY2292 is a third-generation family of clock generators. The CY2292 is upwardly compatible with the industry standard ICD2023 and ICD2028 and continues their tradition by providing a high level of customizable features to meet the diverse clock generation needs of modern motherboards and other synchronous systems.

All parts provide a highly configurable set of clocks for PC motherboard applications. Each of the four configurable clock outputs (CLKA–CLKD) can be assigned 1 of 30 frequencies in any combination. Multiple outputs configured for the same or related^[5] frequencies have low (less than 500 ps) skew, in effect providing on-chip buffering for heavily loaded signals.

The CY2292 can be configured for either 5 V or 3.3 V operation. The internal ROM tables use EPROM technology, allowing full customization of output frequencies. The reference oscillator is designed for 10 MHz to 25 MHz crystals, providing additional flexibility. No external components are required with this crystal. Alternatively, an external reference clock of frequency between 1 MHz and 30 MHz can be used.

Output Configuration

The CY2292 has four independent frequency sources on-chip. These are the reference oscillator and three PLLs. Each PLL has a specific function. The system PLL (SPLL) provides fixed output frequencies on the configurable outputs. The SPLL offers the most output frequency divider options. The CPU PLL (CPLL) is controlled by the select inputs (S0–S2) to provide eight user-selectable frequencies with smooth slewing between frequencies. The utility PLL (UPLL) provides the most accurate clock. It is often used for miscellaneous frequencies not provided by the other frequency sources.

All configurations are EPROM programmable, providing short sample and production lead times. Refer to the application note [Understanding the CY2291 and CY2292](#) for information on configuring the part.

Power Saving Features

The $\overline{\text{SHUTDOWN/OE}}$ input tristates the outputs when pulled LOW. If system shutdown is enabled, a LOW on this pin also shuts off the PLLs, counters, the reference oscillator, and all other active components. The resulting current on the V_{DD} pins is less than 50 μA (for commercial temperature or 100 μA for industrial temperature). After leaving shutdown mode, the PLLs have to relock. All outputs have a weak pull down so that the outputs do not float when tristated.^[6]

The $\overline{\text{S2/SUSPEND}}$ input can be configured to shut down a customizable set of outputs and/or PLLs, when LOW. All PLLs and any of the outputs can be shut off in nearly any combination. The only limitation is that if a PLL is shut off, all outputs derived from it must also be shut off. Suspending a PLL shuts off all

associated logic, while suspending an output simply forces a tristate condition.^[5]

The CPUCLK can slew (transition) smoothly between 20 MHz and the maximum output frequency (100 MHz at 5 V / 80 MHz at 3.3 V for commercial temperature parts or 90 MHz at 5 V / 66.6 MHz at 3.3 V for industrial temperature and for field-programmed parts). This feature is extremely useful in green applications, where reducing the frequency of operation can result in considerable power savings.

CyClocks Software

CyClocks™ is an easy-to-use application that allows you to configure any one of the EPROM-programmable clocks offered by Cypress. Specify the input frequency, PLL and output frequencies, and different functional options. Note the output frequency ranges in this datasheet when specifying them in CyClocks to ensure that you stay within the limits. CyClocks also has a power calculation feature that allows you to see the power consumption of your specific configuration. CyClocks is a sub application located within the CyberClocks™ software. You can download a copy of CyberClocks for free on the Cypress web site at <http://www.cypress.com>.

Cypress FTG Programmer

The Cypress frequency timing generator (FTG) programmer is a portable programmer designed to custom program our family of EPROM field programmable clock devices. The FTG programmer connects to a PC serial port and allow users of CyClocks software to quickly and easily program any of the CY2291F, CY2292F and CY2907F devices. The ordering code for the Cypress FTG Programmer is CY3670. An adapter, the CY3095, connects to the CY3670 and is required for programming the CY2292F.

Custom Configuration Request Procedure

The CY229x are EPROM-programmable devices that may be configured in the factory or in the field by a Cypress field application engineer (FAE). The output frequencies requested is matched as closely as the internal PLL divider and multiplier options allow. All custom requests must be submitted to your local Cypress FAE or sales representative. The method to use to request custom configurations is:

Use CyClocks software. This software automatically calculates the output frequencies that can be generated by the CY229x devices and provides a print-out of final pinout which can be submitted (in electronic or print format) to your local FAE or sales representative.

When the custom request is processed, you receive a part number with a 3-digit extension (for example, CY2292SC-128) specific to the frequencies and pinout of your device. This is the part number used for samples requests and production orders.

Notes

5. Refer to application note [Understanding the CY2291 and CY2292](#) for more information.
6. The CY2292 has weak pull downs on all outputs. Hence, when a tristate condition is forced on the outputs, the output pins are pulled low.

Maximum Ratings

Exceeding maximum ratings may shorten the useful life of the device. User guidelines are not tested.

Supply voltage -0.5 V to +7.0 V
 DC input voltage -0.5 V to +7.0 V
 Storage temperature -65 °C to +150 °C

Maximum soldering temperature (10 sec) 260 °C
 Junction temperature 150 °C
 Package power dissipation 750 mW
 Static discharge voltage ≤ 2000 V
 (per MIL-STD-883, method 3015)

Operating Conditions^[7]

Parameter	Description	Part Numbers	Min	Max	Unit
V _{DD}	Supply voltage, 5.0 V operation	All	4.5	5.5	V
V _{DD}	Supply voltage, 3.3 V operation	All	3.0	3.6	V
T _A	Commercial operating temperature, ambient	CY2292 / CY2292F	0	70	°C
	Industrial operating temperature, ambient	CY2292I / CY2292FI	-40	85	°C
C _{LOAD}	Maximum load capacitance 5.0 V operation	All	-	25	pF
C _{LOAD}	Maximum load capacitance 3.3 V operation	All	-	15	pF
f _{REF}	External reference crystal	All	10.0	25.0	MHz
	External reference clock ^[8, 9, 10]	All	1	30	MHz

Electrical Characteristics, Commercial 5.0 V

Parameter	Description	Conditions	Min	Typ	Max	Unit
V _{OH}	High level output voltage	I _{OH} = 4.0 mA	2.4	-	-	V
V _{OL}	Low level output voltage	I _{OL} = 4.0 mA	-	-	0.4	V
V _{IH}	High level input voltage ^[11]	Except crystal pins	2.0	-	-	V
V _{IL}	Low level input voltage ^[11]	Except crystal pins	-	-	0.8	V
I _{IH}	Input high current	V _{IN} = V _{DD} - 0.5 V	-	< 1	10	μA
I _{IL}	Input low current	V _{IN} = +0.5 V	-	< 1	10	μA
I _{OZ}	Output leakage current	Tristate outputs	-	-	250	μA
I _{DD}	V _{DD} supply current ^[12] commercial	V _{DD} = V _{DD} max, 5 V operation	-	75	100	mA
I _{DDS}	V _{DD} power supply current in shutdown mode ^[12]	Shutdown active	-	10	50	μA

Electrical Characteristics, Commercial 3.3 V

Parameter	Description	Conditions	Min	Typ	Max	Unit
V _{OH}	High level output voltage	I _{OH} = 4.0 mA	2.4	-	-	V
V _{OL}	Low level output voltage	I _{OL} = 4.0 mA	-	-	0.4	V
V _{IH}	High level input voltage ^[11]	Except crystal pins	2.0	-	-	V
V _{IL}	Low level input voltage ^[11]	Except crystal pins	-	-	0.8	V
I _{IH}	Input high current	V _{IN} = V _{DD} - 0.5 V	-	< 1	10	μA
I _{IL}	Input low current	V _{IN} = +0.5 V	-	< 1	10	μA
I _{OZ}	Output leakage current	Tristate outputs	-	-	250	μA
I _{DD}	V _{DD} supply current ^[12] commercial	V _{DD} = V _{DD} max, 3.3 V operation	-	50	65	mA
I _{DDS}	V _{DD} power supply current in shutdown mode ^[12]	Shutdown active	-	10	50	μA

Notes

7. Electrical parameters are guaranteed by design with these operating conditions, unless otherwise noted.
8. External input reference clock must have a duty cycle between 40% and 60%, measured at V_{DD} / 2.
9. Refer to application note "Crystal Oscillator Topics" for information on AC-coupling the external input reference clock.
10. The oscillator circuit is optimized for a crystal reference and for external reference clocks up to 20 MHz. For external reference clocks above 20 MHz, it is recommended that a 150 Ω pull up resistor to V_{DD} be connected to the Xout pin.
11. Xtal inputs have CMOS thresholds.
12. Load = Max, V_{IN} = 0 V or V_{DD}, Typical (-104) configuration, CPUCLK = 66 MHz. Other configurations vary. Power can be approximated by the following formula (multiply by 0.65 for 3 V operation): I_{DD} = 10 + 0.06*(F_{CPLL} + F_{UPLL} + 2*F_{SPLL}) + 0.27*(F_{CLKA} + F_{CLKB} + F_{CLKC} + F_{CLKD} + F_{GPUCLK} + F_{XBUF}).

Electrical Characteristics, Industrial 5.0 V

Parameter	Description	Conditions	Min	Typ	Max	Unit
V _{OH}	High level output voltage	I _{OH} = 4.0 mA	2.4	–	–	V
V _{OL}	Low level output voltage	I _{OL} = 4.0 mA	–	–	0.4	V
V _{IH}	High level input voltage ^[13]	Except crystal pins	2.0	–	–	V
V _{IL}	Low level input voltage ^[13]	Except crystal pins	–	–	0.8	V
I _{IH}	Input high current	V _{IN} = V _{DD} – 0.5 V	–	< 1	10	μA
I _{IL}	Input low current	V _{IN} = +0.5 V	–	< 1	10	μA
I _{OZ}	Output leakage current	Tristate outputs	–	–	250	μA
I _{DD}	V _{DD} supply current ^[14] industrial	V _{DD} = V _{DD} max, 5 V operation	–	75	110	mA
I _{D DS}	V _{DD} power supply current in shutdown mode ^[14]	Shutdown active	–	10	100	μA

Electrical Characteristics, Industrial 3.3 V

Parameter	Description	Conditions	Min	Typ	Max	Unit
V _{OH}	High level output voltage	I _{OH} = 4.0 mA	2.4	–	–	V
V _{OL}	Low level output voltage	I _{OL} = 4.0 mA	–	–	0.4	V
V _{IH}	High level input voltage ^[13]	Except crystal pins	2.0	–	–	V
V _{IL}	Low level input voltage ^[13]	Except crystal pins	–	–	0.8	V
I _{IH}	Input high current	V _{IN} = V _{DD} – 0.5 V	–	< 1	10	μA
I _{IL}	Input low current	V _{IN} = +0.5 V	–	< 1	10	μA
I _{OZ}	Output leakage current	Tristate outputs	–	–	250	μA
I _{DD}	V _{DD} supply current ^[14] industrial	V _{DD} = V _{DD} max, 3.3 V operation	–	50	70	mA
I _{D DS}	V _{DD} power supply current in shutdown mode ^[14]	Shutdown active	–	10	100	μA

Notes

13. Xtal inputs have CMOS thresholds.

14. Load = Max, V_{IN} = 0 V or V_{DD}, Typical (–104) configuration, CPUCLK = 66 MHz. Other configurations vary. Power can be approximated by the following formula (multiply by 0.65 for 3 V operation): I_{DD} = 10 + 0.06•(F_{CP LL} + F_{UP LL} + 2•F_{SPLL}) + 0.27•(F_{CLKA} + F_{CLKB} + F_{CLKC} + F_{CLKD} + F_{CP UCLK} + F_{XBUF}).

Switching Characteristics, Commercial 5.0 V

Parameter	Name	Description	Min	Typ	Max	Unit	
t ₁	Output period	Clock output range, 5 V operation	CY2292SC, SXC	10 (100 MHz)	–	13000 (76.923 kHz)	ns
			CY2292F, FXC, FZX	11.1 (90 MHz)	–	13000 (76.923 kHz)	ns
	Output duty cycle ^[16]	Duty cycle for outputs, defined as $t_2 \div t_1$ ^[17] f _{OUT} ≥ 66 MHz	40	50	60	%	
		Duty cycle for outputs, defined as $t_2 \div t_1$ ^[17] f _{OUT} < 66 MHz	45	50	55	%	
t ₃	Rise time	Output clock rise time ^[18]	–	3	5	ns	
t ₄	Fall time	Output clock fall time ^[18]	–	2.5	4	ns	
t ₅	Output disable time	Time for output to enter tristate mode after SHUTDOWN/OE goes LOW	–	10	15	ns	
t ₆	Output enable time	Time for output to leave tristate mode after SHUTDOWN/OE goes HIGH	–	10	15	ns	
t ₇	Skew	Skew delay between any identical or related outputs ^[15, 17, 19]	–	< 0.25	0.5	ns	
t ₈	CPUCLK slew	Frequency transition rate	1.0	–	20.0	MHz / ms	
t _{9A}	Clock jitter ^[19]	Peak-to-peak period jitter (t _{9A} max – t _{9A} min), percentage of clock period (f _{OUT} ≤ 4 MHz)	–	< 0.5	1	%	
t _{9B}	Clock jitter ^[19]	Peak-to-peak period jitter (t _{9B} max – t _{9B} min) (4 MHz ≤ f _{OUT} ≤ 16 MHz)	–	< 0.7	1	ns	
t _{9C}	Clock jitter ^[19]	Peak-to-peak period jitter (16 MHz < f _{OUT} ≤ 50 MHz)	–	< 400	500	ps	
t _{9D}	Clock jitter ^[19]	Peak-to-peak period jitter (f _{OUT} > 50 MHz)	–	< 250	350	ps	
t _{10A}	Lock time for CPLL	Lock time from power-up	–	< 25	50	ms	
t _{10B}	Lock time for UPLL and SPLL	Lock time from power-up	–	< 0.25	1	ms	
	Slew limits	CPU PLL slew limits	CY2292SC, SXC	20	–	100	MHz
			CY2292F, FXC, FZX	20	–	90	MHz

Switching Characteristics, Commercial 3.3 V

Parameter	Name	Description	Min	Typ	Max	Unit	
t ₁	Output period	Clock output range, 3.3 V operation	CY2292SL, SXL	12.5 (80 MHz)	–	13000 (76.923 kHz)	ns
			CY2292F, FXC, FZX	15 (66.6 MHz)	–	13000 (76.923 kHz)	ns
	Output duty cycle ^[16]	Duty cycle for outputs, defined as $t_2 \div t_1$ ^[17] f _{OUT} ≥ 66 MHz	40	50	60	%	
		Duty cycle for outputs, defined as $t_2 \div t_1$ ^[17] f _{OUT} < 66 MHz	45	50	55	%	
t ₃	Rise time	Output clock rise time ^[18]	–	3	5	ns	
t ₄	Fall time	Output clock fall time ^[18]	–	2.5	4	ns	

Notes

15. Refer to application note [Understanding the CY2291 and CY2292](#) for more information.
16. XBUF duty cycle depends on XTALIN duty cycle.
17. Measured at 1.4 V.
18. Measured between 0.4 V and 2.4 V.
19. Jitter varies with configuration. All standard configurations sample tested at the factory conform to this limit.

Switching Characteristics, Commercial 3.3 V (continued)

Parameter	Name	Description	Min	Typ	Max	Unit	
t ₅	Output disable time	Time for output to enter tristate mode after SHUTDOWN/OE goes LOW	–	10	15	ns	
t ₆	Output enable time	Time for output to leave tristate mode after SHUTDOWN/OE goes HIGH	–	10	15	ns	
t ₇	Skew	Skew delay between any identical or related outputs ^[20, 22, 24]	–	< 0.25	0.5	ns	
t ₈	CPUCLK slew	Frequency transition rate	1.0	–	20.0	MHz / ms	
t _{9A}	Clock jitter ^[24]	Peak-to-peak period jitter (t _{9A} max – t _{9A} min), percentage of clock period (f _{OUT} ≤ 4 MHz)	–	< 0.5	1	%	
t _{9B}	Clock jitter ^[24]	Peak-to-peak period jitter (t _{9B} max – t _{9B} min) (4 MHz ≤ f _{OUT} ≤ 16 MHz)	–	< 0.7	1	ns	
t _{9C}	Clock jitter ^[24]	Peak-to-peak period jitter (16 MHz < f _{OUT} ≤ 50 MHz)	–	< 400	500	ps	
t _{9D}	Clock jitter ^[24]	Peak-to-peak period jitter (f _{OUT} > 50 MHz)	–	< 250	350	ps	
t _{10A}	Lock time for CPLL	Lock time from power-up	–	< 25	50	ms	
t _{10B}	Lock time for UPLL and SPLL	Lock time from power-up	–	< 0.25	1	ms	
	Slew limits	CPU PLL slew limits	CY2292SL, SXL	20	–	80	MHz
			CY2292F, FXC, FZX	20	–	66.6	MHz

Switching Characteristics, Industrial 5.0 V

Parameter	Name	Description	Min	Typ	Max	Unit	
t ₁	Output period	Clock output range, 5 V operation	CY2292SI, SXI	11.1 (90 MHz)	–	13000 (76.923 kHz)	ns
			CY2292FXI, FZXI	12.5 (80 MHz)	–	13000 (76.923 kHz)	ns
	Output duty cycle ^[21]	Duty cycle for outputs, defined as t ₂ ÷ t ₁ ^[22] f _{OUT} ≥ 66 MHz		40	50	60	%
		Duty cycle for outputs, defined as t ₂ ÷ t ₁ ^[22] f _{OUT} < 66 MHz		45	50	55	%
t ₃	Rise time	Output clock rise time ^[23]	–	3	5	ns	
t ₄	Fall time	Output clock fall time ^[23]	–	2.5	4	ns	
t ₅	Output disable time	Time for output to enter tristate mode after SHUTDOWN/OE goes LOW	–	10	15	ns	
t ₆	Output enable time	Time for output to leave tristate mode after SHUTDOWN/OE goes HIGH	–	10	15	ns	
t ₇	Skew	Skew delay between any identical or related outputs ^[20, 22, 24]	–	< 0.25	0.5	ns	
t ₈	CPUCLK slew	Frequency transition rate	1.0	–	20.0	MHz / ms	
t _{9A}	Clock jitter ^[24]	Peak-to-peak period jitter (t _{9A} max – t _{9A} min), percentage of clock period (f _{OUT} ≤ 4 MHz)	–	< 0.5	1	%	
t _{9B}	Clock jitter ^[24]	Peak-to-peak period jitter (t _{9B} max – t _{9B} min) (4 MHz ≤ f _{OUT} ≤ 16 MHz)	–	< 0.7	1	ns	

Notes

20. Refer to application note [Understanding the CY2291 and CY2292](#) for more information.

21. XBUF duty cycle depends on XTALIN duty cycle.

22. Measured at 1.4 V.

23. Measured between 0.4 V and 2.4 V.

24. Jitter varies with configuration. All standard configurations sample tested at the factory conform to this limit.

Switching Characteristics, Industrial 5.0 V (continued)

Parameter	Name	Description	Min	Typ	Max	Unit	
t _{9C}	Clock jitter ^[29]	Peak-to-peak period jitter (16 MHz < f _{OUT} ≤ 50 MHz)	–	< 400	500	ps	
t _{9D}	Clock jitter ^[29]	Peak-to-peak period jitter (f _{OUT} > 50 MHz)	–	< 250	350	ps	
t _{10A}	Lock time for CPLL	Lock time from power-up	–	< 25	50	ms	
t _{10B}	Lock time for UPLL and SPLL	Lock time from power-up	–	< 0.25	1	ms	
	Slew limits	CPU PLL slew limits	CY2292SI, SXI	20	–	90	MHz
			CY2292FXI, FZXI	20	–	80	MHz

Switching Characteristics, Industrial 3.3 V

Parameter	Name	Description	Min	Typ	Max	Unit	
t ₁	Output period	Clock output range, 3.3 V operation	CY2292SI, SXI	15 (66.6 MHz)	–	13000 (76.923 kHz)	ns
			CY2292FXI, FZXI	16.66 (60 MHz)	–	13000 (76.923 kHz)	ns
	Output duty cycle ^[26]	Duty cycle for outputs, defined as t ₂ ÷ t ₁ ^[27] f _{OUT} ≥ 66 MHz	40	50	60	%	
		Duty cycle for outputs, defined as t ₂ ÷ t ₁ ^[27] f _{OUT} < 66 MHz	45	50	55	%	
t ₃	Rise time	Output clock rise time ^[28]	–	3	5	ns	
t ₄	Fall time	Output clock fall time ^[28]	–	2.5	4	ns	
t ₅	Output disable time	Time for output to enter tristate mode after SHUTDOWN/OE goes LOW	–	10	15	ns	
t ₆	Output enable time	Time for output to leave tristate mode after SHUTDOWN/OE goes HIGH	–	10	15	ns	
t ₇	Skew	Skew delay between any identical or related outputs ^[25, 27, 29]	–	< 0.25	0.5	ns	
t ₈	CPUCLK slew	Frequency transition rate	1.0	–	20.0	MHz / ms	
t _{9A}	Clock jitter ^[29]	Peak-to-peak period jitter (t _{9A} max – t _{9A} min), percentage of clock period (f _{OUT} ≤ 4 MHz)	–	< 0.5	1	%	
t _{9B}	Clock jitter ^[29]	Peak-to-peak period jitter (t _{9B} max – t _{9B} min) (4 MHz ≤ f _{OUT} ≤ 16 MHz)	–	< 0.7	1	ns	
t _{9C}	Clock jitter ^[29]	Peak-to-peak period jitter (16 MHz < f _{OUT} ≤ 50 MHz)	–	< 400	500	ps	
t _{9D}	Clock jitter ^[29]	Peak-to-peak period jitter (f _{OUT} > 50 MHz)	–	< 250	350	ps	
t _{10A}	Lock time for CPLL	Lock time from power-up	–	< 25	50	ms	
t _{10B}	Lock time for UPLL and SPLL	Lock time from power-up	–	< 0.25	1	ms	
	Slew limits	CPU PLL slew limits	CY2292SI, SXI	20	–	66.6	MHz
			CY2292FXI, FZXI	20	–	60	MHz

Notes

25. Refer to application note [Understanding the CY2291 and CY2292](#) for more information.
 26. XBUF duty cycle depends on XTALIN duty cycle.
 27. Measured at 1.4 V.
 28. Measured between 0.4 V and 2.4 V.
 29. Jitter varies with configuration. All standard configurations sample tested at the factory conform to this limit.

Switching Waveforms

Figure 2. All Outputs, Duty Cycle and Rise / Fall Time

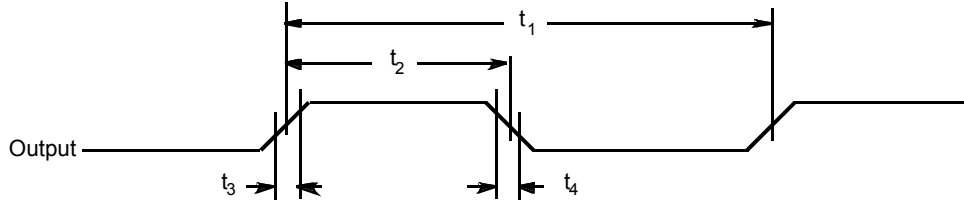

Figure 3. Output Tristate Timing^[30]

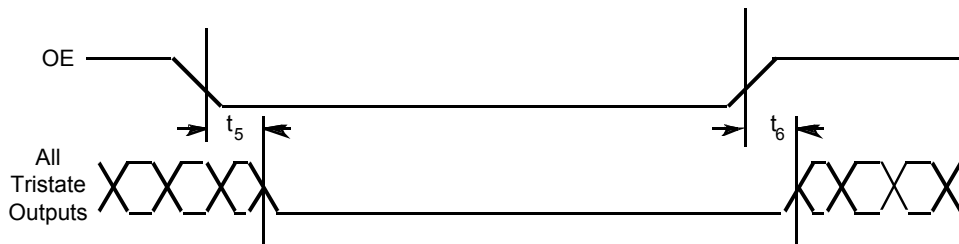

Figure 4. CLK Outputs Jitter and Skew

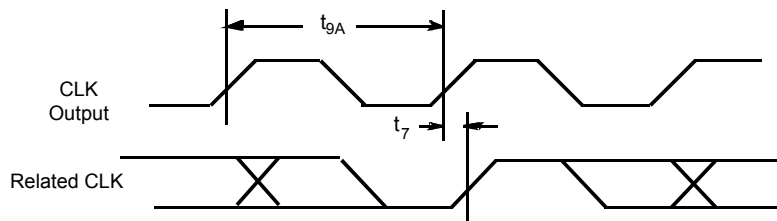
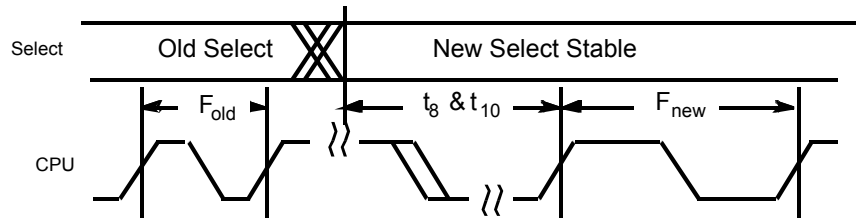

Figure 5. CPU Frequency Change



Note

30. The CY2292 has weak pull downs on all outputs. Hence, when a tristate condition is forced on the outputs, the output pins are pulled low.

Test Circuit

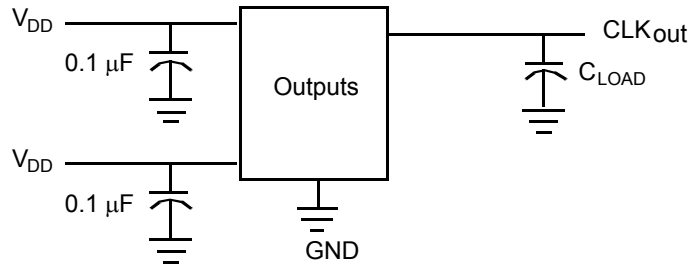

Ordering Information

Ordering Code	Package Type	Operating Range	Operating Voltage
Pb-free			
CY2292FXC	16-pin SOIC	Commercial, 0 °C to 70 °C	3.3 V or 5.0 V
CY2292FXCT	16-pin SOIC – Tape and Reel	Commercial, 0 °C to 70 °C	3.3 V or 5.0 V
CY2292FXI	16-pin SOIC	Industrial, –40 °C to 85 °C	3.3 V or 5.0 V
CY2292FXIT	16-pin SOIC – Tape and Reel	Industrial, –40 °C to 85 °C	3.3 V or 5.0 V
CY2292FZX	16-pin TSSOP	Commercial, 0 °C to 70 °C	3.3 V or 5.0 V
CY2292FZXT	16-pin TSSOP – Tape and Reel	Commercial, 0 °C to 70 °C	3.3 V or 5.0 V
CY2292FZXI	16-pin TSSOP	Industrial, –40 °C to 85 °C	3.3 V or 5.0 V
CY2292FZXIT	16-pin TSSOP – Tape and Reel	Industrial, –40 °C to 85 °C	3.3 V or 5.0 V
Programmer			
CY3670	FTG Clock Programmer		
CY3095	Adapter for programming the CY2292F on the CY3670		

Possible Configurations

Some product offerings are factory programmed customer specific devices with customized part numbers. This table shows the available device types, but not complete part numbers. Contact your local Cypress FAE or Sales Representative for more information

Ordering Code	Package Type	Operating Range	Operating Voltage
Pb-free			
CY2292SXC–XXX	16-pin SOIC	Commercial, 0 °C to 70 °C	5.0 V
CY2292SXC–XXXT	16-pin SOIC – Tape and Reel	Commercial, 0 °C to 70 °C	5.0 V
CY2292SXL–XXX	16-pin SOIC	Commercial, 0 °C to 70 °C	3.3 V
CY2292SXI–XXX	16-pin SOIC	Industrial, –40 °C to 85 °C	3.3 V or 5.0 V
CY2292SXI–XXXT	16-pin SOIC – Tape and Reel	Industrial, –40 °C to 85 °C	3.3 V or 5.0 V

Ordering Code Definition

CY 2292 (F) (S) X (C) (-xxx) (T)

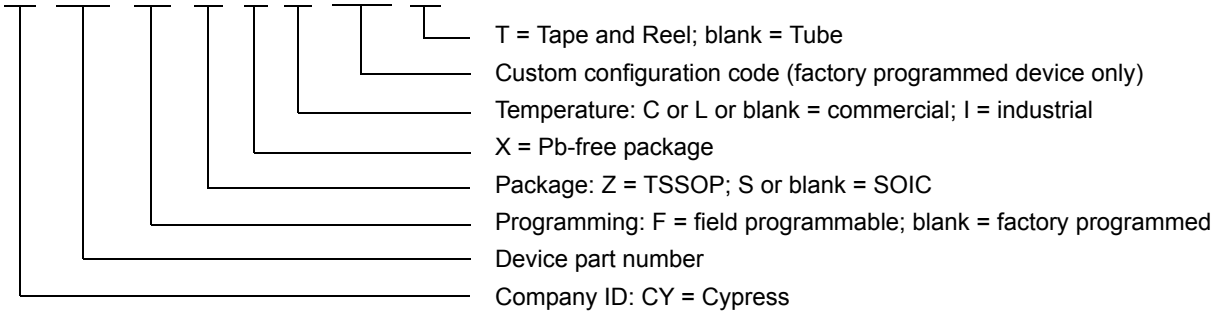

Package Characteristics

Package	θ_{JA} (°C/W)	θ_{JC} (°C/W)	Transistor Count
16-pin SOIC	83	19	9271

Package Diagrams

Figure 6. 16-Pin (150-Mil) SOIC S16.15

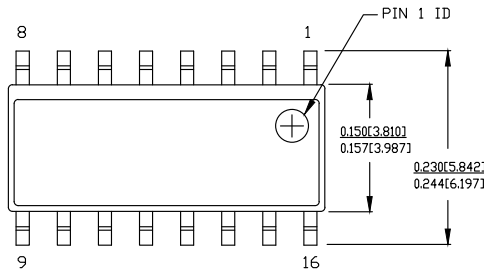

DIMENSIONS IN INCHES[MM] MIN. MAX.
 REFERENCE JEDEC MS-012
 PACKAGE WEIGHT 0.15gms

PART #	
S16.15	STANDARD PKG.
SZ16.15	LEAD FREE PKG.

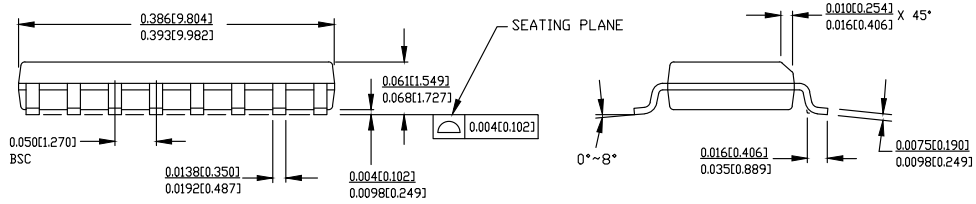

51-85068 °C

Figure 7. 16-Pin TSSOP 4.40 mm Body Z16.173

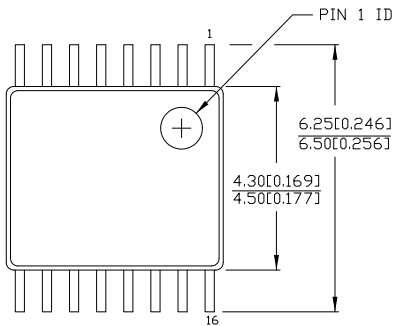

DIMENSIONS IN MM[INCHES] MIN. MAX.
 REFERENCE JEDEC MO-153
 PACKAGE WEIGHT 0.05gms

PART #	
Z16.173	STANDARD PKG.
ZZ16.173	LEAD FREE PKG.

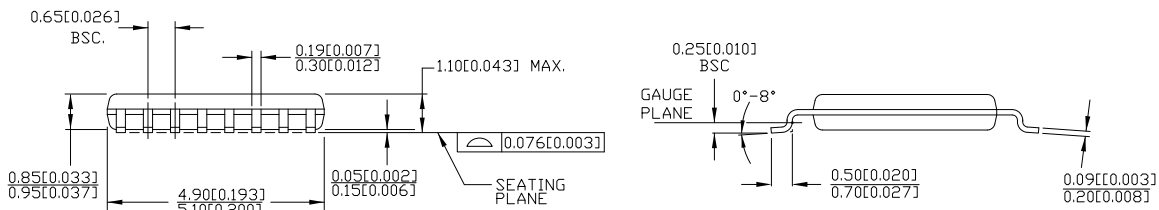

51-85091 °C

Acronyms

Acronym	Description
CPU	central processing unit
CMOS	complementary metal oxide semiconductor
DC	direct current
EPROM	erasable programmable read only memory
FAE	field application engineer
FTG	frequency Timing Group
OE	output enable
OSC	oscillator
PD	power down
PLL	phase locked loop
ROM	read only memory
SOIC	small outline integrated circuit
TSSOP	thin shrunk small outline package

Document Conventions

Units of Measure

Symbol	Unit of Measure
°C	degree Celsius
kΩ	kilohms
MHz	megahertz
μA	microamperes
mA	milliamperes
ms	milliseconds
mW	milliwatts
ns	nanoseconds
Ω	ohms
%	percent
pF	picofarads
ppm	parts per million
ps	picoseconds
V	volts

Document History Page

Document Title: CY2292 Three PLL General Purpose EPROM Programmable Clock Generator Document Number: 38-07449				
Revision	ECN	Orig. of Change	Submission Date	Description of Change
**	116993	DSG	07/01/02	Changed from Spec number: 38-00946 to 38-07449
*A	119639	CKN	12/05/02	Changed 8 MHz to 20 MHz in Power-saving Features
*B	277130	RGL	10/26/04	Added Lead-free Devices
*C	395808	RGL	09/07/05	Minor Change: fixed the typo in the ordering code
*D	2565316	AESA/KVM	09/16/08	Updated template. Added Note "Not recommended for new designs." Removed parts: CY2292FI, CY2292FIT, CY2292FZ, and CY2292FZT. Changed Lead-Free to Pb-Free. Changed CyClock reference to include Cyber-Clock
*E	2761988	KVM	09/10/09	Corrected operating range attribute for CY2292FZXI and CY2292FZXI in Ordering Information table. Revised Selector Guide (p. 1): removed Outputs column, updated part number suffixes, and consolidated two rows Updated part number suffixes in Switching Characteristics tables
*F	2897775	KVM	03/23/10	Removed inactive parts from the ordering information table. Moved xxx parts to Possible Configurations table. Updated package diagrams.
*G	2948137	KVM	06/09/10	Updated Figure 1 title (to include both SOIC and TSSOP) Added table of contents. Added Acronyms
*H	3010397	KVM	08/18/2010	Added ordering code definition. Added programmer and adapter to ordering information table. Added CY3095 adapter to programmer text description. Removed reference to obsolete CY2071F.

Sales, Solutions, and Legal Information

Worldwide Sales and Design Support

Cypress maintains a worldwide network of offices, solution centers, manufacturers' representatives, and distributors. To find the office closest to you, visit us at [Cypress Locations](#).

Products

Automotive	cypress.com/go/automotive
Clocks & Buffers	cypress.com/go/clocks
Interface	cypress.com/go/interface
Lighting & Power Control	cypress.com/go/powerpsoc cypress.com/go/plc
Memory	cypress.com/go/memory
Optical & Image Sensing	cypress.com/go/image
PSoC	cypress.com/go/psoc
Touch Sensing	cypress.com/go/touch
USB Controllers	cypress.com/go/USB
Wireless/RF	cypress.com/go/wireless

PSoC® Solutions

psoc.cypress.com/solutions
PSoC 1 | PSoC 3 | PSoC 5

© Cypress Semiconductor Corporation, 2002-2010. The information contained herein is subject to change without notice. Cypress Semiconductor Corporation assumes no responsibility for the use of any circuitry other than circuitry embodied in a Cypress product. Nor does it convey or imply any license under patent or other rights. Cypress products are not warranted nor intended to be used for medical, life support, life saving, critical control or safety applications, unless pursuant to an express written agreement with Cypress. Furthermore, Cypress does not authorize its products for use as critical components in life-support systems where a malfunction or failure may reasonably be expected to result in significant injury to the user. The inclusion of Cypress products in life-support systems application implies that the manufacturer assumes all risk of such use and in doing so indemnifies Cypress against all charges.

Any Source Code (software and/or firmware) is owned by Cypress Semiconductor Corporation (Cypress) and is protected by and subject to worldwide patent protection (United States and foreign), United States copyright laws and international treaty provisions. Cypress hereby grants to licensee a personal, non-exclusive, non-transferable license to copy, use, modify, create derivative works of, and compile the Cypress Source Code and derivative works for the sole purpose of creating custom software and or firmware in support of licensee product to be used only in conjunction with a Cypress integrated circuit as specified in the applicable agreement. Any reproduction, modification, translation, compilation, or representation of this Source Code except as specified above is prohibited without the express written permission of Cypress.

Disclaimer: CYPRESS MAKES NO WARRANTY OF ANY KIND, EXPRESS OR IMPLIED, WITH REGARD TO THIS MATERIAL, INCLUDING, BUT NOT LIMITED TO, THE IMPLIED WARRANTIES OF MERCHANTABILITY AND FITNESS FOR A PARTICULAR PURPOSE. Cypress reserves the right to make changes without further notice to the materials described herein. Cypress does not assume any liability arising out of the application or use of any product or circuit described herein. Cypress does not authorize its products for use as critical components in life-support systems where a malfunction or failure may reasonably be expected to result in significant injury to the user. The inclusion of Cypress' product in a life-support systems application implies that the manufacturer assumes all risk of such use and in doing so indemnifies Cypress against all charges.

Use may be limited by and subject to the applicable Cypress software license agreement.