

フェライトチップビーズ アイテム一覧表

FERRITE CHIP BEADS LINEUP LIST

積層タイプのハイロスインダクタ (BK) シリーズと、巻線タイプの角チップビーズインダクタ (FBM) シリーズのタイプの違う2つのシリーズで、高速信号ラインやGHz帯のノイズ対策から大電流まで広範囲の用途に対応。

The combination of the BK Series multilayer high-loss inductors and the FBM series wire wound chip ferrite beads allow you to cover a wide (broad) range of noise suppression (countermeasure) needs, from GHz range signal lines to high current power circuit lines.

フェライトチップビーズ 一覧表 Ferrite chip beads lineup list

Size	品名 Ordering Code	EHS (Environmental Hazardous Substances)	インピーダンス Impedance [Ω]	直流抵抗 DC resistance [Ω] (max.)	定格電流 Rated current [mA] (max.)	用途 Application	Page
0603 (0201) 積層ハイロス インダクタ Multilayer Ferrite Chip Beads	BK 0603 HS 220	RoHS	22±25%	0.065	500	keeps signal integrity	214
	BK 0603 HS 330	RoHS	33±25%	0.070	500	keeps signal integrity	
	BK 0603 HS 800	RoHS	80±25%	0.40	200	keeps signal integrity	
	BK 0603 HS 121	RoHS	120±25%	0.45	200	keeps signal integrity	
	BK 0603 HS 241	RoHS	240±25%	0.65	200	keeps signal integrity	
	BK 0603 HS 601	RoHS	600±25%	1.20	150	keeps signal integrity	
	BK 0603 HM 600	RoHS	60±25%	0.25	200	suppresses general noise	
	BK 0603 HM 121	RoHS	120±25%	0.40	200	suppresses general noise	
	BK 0603 HM 241	RoHS	240±25%	0.80	200	suppresses general noise	
	BK 0603 HM 471	RoHS	470±25%	1.05	100	suppresses general noise	
	BK 0603 LL 100	RoHS	10±25%	0.25	200	For high speed signal line	
	BK 0603 LL 220	RoHS	22±25%	0.45	200	For high speed signal line	
	BK 0603 LL 330	RoHS	33±25%	0.55	150	For high speed signal line	
	BK 0603 LL 470	RoHS	47±25%	0.70	150	For high speed signal line	
	BK 0603 LL 560	RoHS	56±25%	1.00	100	For high speed signal line	
	BK 0603 LL 121	RoHS	120±25%	1.50	100	For high speed signal line	
	1005 (0402) 積層ハイロス インダクタ Multilayer Ferrite Chip Beads	BKP 1005 HS 100	RoHS	10±5Ω	0.030	2000	
BKP 1005 HS 330		RoHS	33±25%	0.050	1700	For power supply line	
BKP 1005 HS 680		RoHS	68±25%	0.075	1500	For power supply line	
BKP 1005 HS 121		RoHS	120±25%	0.140	1000	For power supply line	
BKP 1005 HS 221		RoHS	220±25%	0.200	800	For power supply line	
BKP 1005 HM 121		RoHS	120±25%	0.120	1100	For power supply line	
BKP 1005 HM 221		RoHS	220±25%	0.180	900	For power supply line	
BK 1005 HW 680		RoHS	68±25%	0.17	500	keeps signal integrity	
BK 1005 HW 121		RoHS	120±25%	0.24	450	keeps signal integrity	
BK 1005 HW 241		RoHS	240±25%	0.31	400	keeps signal integrity	
BK 1005 HW 431		RoHS	430±25%	0.50	350	keeps signal integrity	
BK 1005 HW 601		RoHS	600±25%	0.60	300	keeps signal integrity	
BK 1005 HS 100		RoHS	10±25%	0.03	1000	For power supply line	
BK 1005 HS 330		RoHS	33±25%	0.06	700	For power supply line	
BK 1005 HS 680		RoHS	68±25%	0.10	700	For power supply line	
BK 1005 HS 800		RoHS	80±25%	0.10	700	For power supply line	
BK 1005 HS 121		RoHS	120±25%	0.20	500	keeps signal integrity	
BK 1005 HS 241		RoHS	240±25%	0.30	400	keeps signal integrity	
BK 1005 HS 431		RoHS	430±25%	0.45	350	keeps signal integrity	
BK 1005 HS 601		RoHS	600±25%	0.55	300	keeps signal integrity	
BK 1005 HS 102		RoHS	1000±25%	0.58	300	keeps signal integrity	
BK 1005 HM 121		RoHS	120±25%	0.18	300	suppresses general noise	
BK 1005 HM 241		RoHS	240±25%	0.30	300	suppresses general noise	
BK 1005 HM 471		RoHS	470±25%	0.45	250	suppresses general noise	
BK 1005 HM 601		RoHS	600±25%	0.50	250	suppresses general noise	
BK 1005 HM 102		RoHS	1000±25%	0.70	150	suppresses general noise	
BK 1005 LL 100		RoHS	10±25%	0.11	500	For high speed signal line	
BK 1005 LL 220		RoHS	22±25%	0.18	400	For high speed signal line	
BK 1005 LL 330		RoHS	33±25%	0.25	400	For high speed signal line	
BK 1005 LL 470		RoHS	47±25%	0.33	350	For high speed signal line	
BK 1005 LL 680		RoHS	68±25%	0.31	400	For high speed signal line	
BK 1005 LL 121		RoHS	120±25%	0.45	350	For high speed signal line	
BK 1005 LL 181		RoHS	180±25%	0.50	300	For high speed signal line	
BK 1005 LL 241	RoHS	240±25%	0.70	250	For high speed signal line		
BK 1005 LM 182	RoHS	1800±25%	0.90	120	suppresses general noise		
1608 (0603) 積層ハイロス インダクタ Multilayer Ferrite Chip Beads	BKP 1608 HS 330	RoHS	33±25%	0.025	3000	For power supply line	228
	BKP 1608 HS 600	RoHS	60±25%	0.040	2500	For power supply line	
	BKP 1608 HS 101	RoHS	100±25%	0.050	1700	For power supply line	
	BKP 1608 HS 121	RoHS	120±25%	0.035	2700	For power supply line	
	BKP 1608 HS 181	RoHS	180±25%	0.075	1500	For power supply line	
	BKP 1608 HS 271	RoHS	270±25%	0.110	1200	For power supply line	
	BKP 1608 HS 391	RoHS	390±25%	0.140	1000	For power supply line	
	BK 1608 HW 121	RoHS	120±25%	0.15	600	keeps signal integrity	
	BK 1608 HW 241	RoHS	240±25%	0.25	450	keeps signal integrity	
	BK 1608 HW 431	RoHS	430±25%	0.30	400	keeps signal integrity	
	BK 1608 HW 601	RoHS	600±25%	0.40	300	keeps signal integrity	
	BK 1608 HS 220	RoHS	22±25%	0.05	1500	For power supply line	
	BK 1608 HS 330	RoHS	33±25%	0.08	1200	For power supply line	
	BK 1608 HS 470	RoHS	47±25%	0.10	900	For power supply line	
	BK 1608 HS 600	RoHS	60±25%	0.10	800	For power supply line	
	BK 1608 HS 800	RoHS	80±25%	0.10	600	For power supply line	
	BK 1608 HS 121	RoHS	120±25%	0.18	500	keeps signal integrity	
BK 1608 HS 241	RoHS	240±25%	0.25	400	keeps signal integrity		
BK 1608 HS 601	RoHS	600±25%	0.45	350	keeps signal integrity		
BK 1608 HS 102	RoHS	1000±25%	0.60	300	keeps signal integrity		
BK 1608 HM 121	RoHS	120±25%	0.20	350	suppresses general noise		

フェライトチップビーズ 一覧表 Ferrite chip beads lineup list

Size	品名 Ordering Code	EHS (Environmental Hazardous Substances)	インピーダンス Impedance 〔Ω〕	直流抵抗 DC resistance 〔Ω〕(max.)	定格電流 Rated current (mA)(max.)	用途 Application	Page
1608 (0603) 積層ハイロス インダクタ Multilayer Ferrite Chip Beads	BK 1608 HM 241	RoHS	240±25%	0.35	300	suppresses general noise	214
	BK 1608 HM 471	RoHS	470±25%	0.45	250	suppresses general noise	
	BK 1608 HM 601	RoHS	600±25%	0.60	250	suppresses general noise	
	BK 1608 HM 102	RoHS	1000±25%	0.70	200	suppresses general noise	
	BK 1608 LL 300	RoHS	30±25%	0.20	500	For high speed signal line	
	BK 1608 LL 470	RoHS	47±25%	0.30	400	For high speed signal line	
	BK 1608 LL 560	RoHS	56±25%	0.30	400	For high speed signal line	
	BK 1608 LL 680	RoHS	68±25%	0.35	300	For high speed signal line	
	BK 1608 LL 121	RoHS	120±25%	0.50	300	For high speed signal line	
	BK 1608 LL 181	RoHS	180±25%	0.65	250	For high speed signal line	
	BK 1608 LL 241	RoHS	240±25%	0.80	250	For high speed signal line	
	BK 1608 LL 331	RoHS	330±25%	0.85	200	For high speed signal line	
	BK 1608 LL 431	RoHS	430±25%	0.85	200	For high speed signal line	
	BK 1608 LL 511	RoHS	510±25%	0.90	200	For high speed signal line	
	BK 1608 LL 681	RoHS	680±25%	1.00	150	For high speed signal line	
	BK 1608 LM 751	RoHS	750±25%	0.60	300	suppresses general noise	
	BK 1608 LM 152	RoHS	1500±25%	0.75	250	suppresses general noise	
	BK 1608 LM 182	RoHS	1800±25%	0.85	200	suppresses general noise	
	BK 1608 LM 252	RoHS	2500±25%	1.10	200	suppresses general noise	
	BK 1608 TS 431	RoHS	430±25%	0.21±30%	400	Rdc tolerance specified type	
BK 1608 TS 601	RoHS	600±25%	0.27±30%	350	Rdc tolerance specified type		
BK 1608 TS 102	RoHS	1000±25%	0.30±30%	300	Rdc tolerance specified type		
1608 (0603) 角チップビーズ インダクタ Rectangular Ferrite Beads (HighCurrent)	FB MJ1608 HS 280NT	RoHS	28±30%	0.007	4000	High current type	262
	FB MJ1608 HM 230NT	RoHS	23±30%	0.007	4000	High current type	
	FB MH1608 HM 470-T	RoHS	47±25%	0.020	3500	GHz range noise attenuation,High current type	
	FB MH1608 HM 600-T	RoHS	60±25%	0.025	3000	GHz range noise attenuation,High current type	
	FB MH1608 HM 101-T	RoHS	100±25%	0.035	2000	GHz range noise attenuation,High current type	
	FB MH1608 HM 151-T	RoHS	150±25%	0.050	2000	GHz range noise attenuation,High current type	
	FB MH1608 HM 221-T	RoHS	220±25%	0.070	1500	GHz range noise attenuation,High current type	
	FB MH1608 HM 331-T	RoHS	330±25%	0.130	900	GHz range noise attenuation,High current type	
	FB MH1608 HM 471-T	RoHS	470±25%	0.150	700	GHz range noise attenuation,High current type	
	FB MH1608 HM 601-T	RoHS	600±25%	0.170	700	GHz range noise attenuation,High current type	
	FB MH1608 HM 102-T	RoHS	1000±25%	0.350	500	GHz range noise attenuation	
	FB MH1608 HL 300-T	RoHS	30±25%	0.028	2500	GHz range noise attenuation,High current type	
	FB MH1608 HL 600-T	RoHS	60±25%	0.045	1800	GHz range noise attenuation,High current type	
	FB MH1608 HL 121-T	RoHS	120±25%	0.130	900	GHz range noise attenuation,High current type	
	FB MH1608 HL 221-T	RoHS	220±25%	0.170	700	GHz range noise attenuation,High current type	
	FB MH1608 HL 331-T	RoHS	330±25%	0.210	600	GHz range noise attenuation,High current type	
FB MH1608 HL 471-T	RoHS	470±25%	0.350	500	GHz range noise attenuation		
FB MH1608 HL 601-T	RoHS	600±25%	0.450	400	GHz range noise attenuation		
2125 (0805) 積層ハイロス インダクタ Multilayer Ferrite Chip Beads	BKP 2125 HS 330	RoHS	33±25%	0.020	4000	For power supply line	228
	BKP 2125 HS 600	RoHS	60±25%	0.025	3000	For power supply line	
	BKP 2125 HS 101	RoHS	100±25%	0.040	2500	For power supply line	
	BKP 2125 HS 221	RoHS	220±25%	0.050	2000	For power supply line	
	BKP 2125 HS 331	RoHS	330±25%	0.075	1500	For power supply line	
	BK 2125 HS 150	RoHS	15±25%	0.05	1200	For power supply line	
	BK 2125 HS 220	RoHS	22±25%	0.05	1200	For power supply line	
	BK 2125 HS 330	RoHS	33±25%	0.05	1200	For power supply line	
	BK 2125 HS 470	RoHS	47±25%	0.05	1000	For power supply line	
	BK 2125 HS 750	RoHS	75±25%	0.10	1000	For power supply line	
	BK 2125 HS 101	RoHS	100±25%	0.10	900	For power supply line	
	BK 2125 HS 121	RoHS	120±25%	0.15	800	keeps signal integrity	
	BK 2125 HS 241	RoHS	240±25%	0.20	600	keeps signal integrity	
	BK 2125 HS 431	RoHS	430±25%	0.25	500	keeps signal integrity	
	BK 2125 HS 601	RoHS	600±25%	0.30	500	keeps signal integrity	
	BK 2125 HS 102	RoHS	1000±25%	0.40	300	keeps signal integrity	
	BK 2125 HM 121	RoHS	120±25%	0.15	800	suppresses general noise	
	BK 2125 HM 241	RoHS	240±25%	0.20	600	suppresses general noise	
	BK 2125 HM 471	RoHS	470±25%	0.25	500	suppresses general noise	
	BK 2125 HM 601	RoHS	600±25%	0.25	500	suppresses general noise	
	BK 2125 HM 102	RoHS	1000±25%	0.35	400	suppresses general noise	
	BK 2125 LL 560	RoHS	56±25%	0.20	600	For high speed signal line	
	BK 2125 LL 121	RoHS	120±25%	0.30	400	For high speed signal line	
	BK 2125 LL 241	RoHS	240±25%	0.35	300	For high speed signal line	
BK 2125 LM 751	RoHS	750±25%	0.30	400	suppresses general noise		
BK 2125 LM 152	RoHS	1500±25%	0.35	400	suppresses general noise		
BK 2125 LM 182	RoHS	1800±25%	0.45	300	suppresses general noise		
BK 2125 LM 252	RoHS	2500±25%	0.75	200	suppresses general noise		
2125、2016、2012 (0805、0806、0804) 角チップビーズ インダクタ Rectangular Ferrite Beads (High Current)	FB MJ2125 HS 420-T	RoHS	42±25%	0.008	4000	High current type	262
	FB MJ2125 HS 250NT	RoHS	25±30%	0.004	6000	High current type	
	FB MJ2125 HM 330-T	RoHS	33±25%	0.008	4000	High current type	
	FB MJ2125 HM 210NT	RoHS	21±30%	0.004	6000	High current type	
	FB MJ2125 HL 8RONT	RoHS	8±30%	0.010	2000	High current type	
	FB MH2016 HM 251NT	RoHS	250±30%	0.050	2000	GHz range noise attenuation,High current type	

フェライトチップビーズ 一覧表 Ferrite chip beads lineup list

Size	品名 Ordering Code	EHS (Environmental Hazardous Substances)	インピーダンス Impedance [Ω]	直流抵抗 DC resistance [Ω] (max.)	定格電流 Rated current [mA] (max.)	用途 Application	Page
2125, 2016, 2012 (0805, 0806, 0804) 角チップインダクタ Rectangular Ferrite Beads (High Current)	FB MH 2012 HM 800-T	RoHS	80±25%	0.025	2700	GHz range noise attenuation, High current type	262
	FB MH 2012 HM 121-T	RoHS	120±25%	0.032	2500	GHz range noise attenuation, High current type	
	FB MH 2012 HM 221-T	RoHS	220±25%	0.060	2000	GHz range noise attenuation, High current type	
3216, 3225 (1206, 1210) 角チップビーズ インダクタ Rectangular Ferrite Beads (High Current)	FB MH 2012 HM 331-T	RoHS	330±25%	0.080	1800	GHz range noise attenuation, High current type	262
	FB MJ 3216 HS 800-T	RoHS	80±25%	0.010	4000	High current type	
	FB MJ 3216 HS 480NT	RoHS	48±30%	0.005	6000	High current type	
	FB MJ 3216 HM 600-T	RoHS	60±25%	0.010	4000	High current type	
	FB MJ 3216 HM 380NT	RoHS	38±30%	0.005	6000	High current type	
	FB MH 3216 HM 501NT	RoHS	500±30%	0.070	2000	High Impedance, High current type	
	FB MH 3225 HM 601NT	RoHS	600±30%	0.042	3000	High Impedance, High current type	
45 ○○ (18**) 角チップビーズ インダクタ Rectangular Ferrite Beads (High Current)	FB MJ 4516 HS 111-T	RoHS	110±25%	0.014	4000	High current type	262
	FB MJ 4516 HS 720NT	RoHS	72±30%	0.007	6000	High current type	
	FB MJ 4516 HM 900-T	RoHS	90±25%	0.014	4000	High current type	
	FB MJ 4516 HM 560NT	RoHS	56±30%	0.007	6000	High current type	
	FB MH 4516 HM 851NT	RoHS	850±30%	0.100	1500	High Impedance, High current type	
	FB MH 4525 HM 102NT	RoHS	1000±30%	0.060	3000	High Impedance, High current type	
	FB MH 4525 HM 162NT	RoHS	1600±30%	0.130	2000	High Impedance, High current type	
	FB MH 4532 HM 681-T	RoHS	680±25%	0.028	4000	High Impedance, High current type	
	FB MH 4532 HM 132-T	RoHS	1300±25%	0.060	3000	High Impedance, High current type	
	FB MH 4532 HM 202-T	RoHS	2000±25%	0.130	1300	High Impedance, High current type	
2010 (0804) 積層ハイロス インダクタ アレイ Multilayer Ferrite Chip Beads Array	BK 2010 4W 680	RoHS	68±25%	0.35	100	keeps signal integrity	232
	BK 2010 4W 121	RoHS	120±25%	0.40	100	keeps signal integrity	
	BK 2010 4W 241	RoHS	240±25%	0.50	100	keeps signal integrity	
	BK 2010 4S 121	RoHS	120±25%	0.30	100	keeps signal integrity	
	BK 2010 4S 241	RoHS	240±25%	0.45	100	keeps signal integrity	
	BK 2010 4S 431	RoHS	430±25%	0.55	100	keeps signal integrity	
	BK 2010 4S 601	RoHS	600±25%	0.70	100	keeps signal integrity	
	BK 2010 4M 121	RoHS	120±25%	0.30	100	suppresses general noise	
	BK 2010 4M 241	RoHS	240±25%	0.45	100	suppresses general noise	
	BK 2010 4M 431	RoHS	430±25%	0.55	100	suppresses general noise	
	BK 2010 4M 601	RoHS	600±25%	0.70	100	suppresses general noise	
	BK 2010 4M 102	RoHS	1000±25%	0.80	100	suppresses general noise	
	BK 2010 4L 050	RoHS	5±25%	0.10	100	For high speed signal line	
	BK 2010 4L 100	RoHS	10±25%	0.15	100	For high speed signal line	
	BK 2010 4L 220	RoHS	22±25%	0.20	100	For high speed signal line	
	BK 2010 4L 330	RoHS	33±25%	0.30	100	For high speed signal line	
	BK 2010 4L 470	RoHS	47±25%	0.40	100	For high speed signal line	
	BK 2010 4L 680	RoHS	68±25%	0.50	100	For high speed signal line	
	BK 2010 4L 121	RoHS	120±25%	0.70	100	For high speed signal line	
	BK 2010 4L 181	RoHS	180±25%	0.90	100	For high speed signal line	
3216 (1206) 積層ハイロス インダクタ アレイ Multilayer Ferrite Chip Beads Array	BK 3216 4W 121	RoHS	120±25%	0.15	100	keeps signal integrity	232
	BK 3216 4W 241	RoHS	240±25%	0.25	100	keeps signal integrity	
	BK 3216 4W 431	RoHS	430±25%	0.35	100	keeps signal integrity	
	BK 3216 4W 601	RoHS	600±25%	0.40	100	keeps signal integrity	
	BK 3216 4S 600	RoHS	60±25%	0.18	200	keeps signal integrity	
	BK 3216 4S 121	RoHS	120±25%	0.18	200	keeps signal integrity	
	BK 3216 4S 241	RoHS	240±25%	0.30	200	keeps signal integrity	
	BK 3216 4S 301	RoHS	300±25%	0.40	200	keeps signal integrity	
	BK 3216 4S 471	RoHS	470±25%	0.40	200	keeps signal integrity	
	BK 3216 4S 601	RoHS	600±25%	0.45	200	keeps signal integrity	
	BK 3216 4S 102	RoHS	1000±25%	0.68	100	keeps signal integrity	
	BK 3216 4M 121	RoHS	120±25%	0.20	150	suppresses general noise	
	BK 3216 4M 241	RoHS	240±25%	0.35	150	suppresses general noise	
	BK 3216 4M 301	RoHS	300±25%	0.45	150	suppresses general noise	
	BK 3216 4M 471	RoHS	470±25%	0.50	150	suppresses general noise	
	BK 3216 4M 601	RoHS	600±25%	0.60	100	suppresses general noise	
	BK 3216 4M 102	RoHS	1000±25%	0.80	100	suppresses general noise	
	BK 3216 4L 680	RoHS	68±25%	0.35	200	For high speed signal line	
	BK 3216 4L 121	RoHS	120±25%	0.55	200	For high speed signal line	
	BK 3216 4L 181	RoHS	180±25%	0.65	150	For high speed signal line	
BK 3216 4L 241	RoHS	240±25%	0.75	150	For high speed signal line		

用途
Application keeps signal integrity ; 信号ラインの波形品位重視
For general noise attenuation ; 一般的なノイズ対策
For signal line, Power supply line ; 一般信号ライン及び電源ライン
For high speed signal line ; 高速信号ライン
Rdc tolerance specified type ; Rdc 許容差規定品
High Impedance, High current type ; 高インピーダンス、大電流用
High current type ; 大電流用
GHz range attenuation, High current type ; GHz帯ノイズ対策、大電流用

フェライトチップビーズ タイプ別一覧 Product lineup list by function

Type	Current	Size					
		0603	1005	1608	2012, 2125	3200	4500
<p>Low-Q</p> <p>[HS series]:XL成分を抑え、波形品位の低下を抑制</p> <p>Suppresses the component. Helps stop the reduction of the wave-form integrity.</p> <p>[HW series]:シリーズ中最もXL成分を抑えた設計により、波形品位低下の抑止と共に高周波域での減衰も確保</p> <p>The best material in the BK Series to suppress the XL component and stop the reduction of the wave-form integrity while maintaining attenuation in the high-frequency.</p> <p>FBMJシリーズは、大電流・低Rdcタイプ (Max 2~6A)</p> <p>FBMJ series be a large current and low Rdc type. (Max2~6A)</p>	~500mA	BK 0603HS220 BK 0603HS330 BK 0603HS800 BK 0603HS121 BK 0603HS241 BK 0603HS601	BK 1005HW680 BK 1005HW121 BK 1005HW241 BK 1005HW431 BK 1005HW601 BK 1005HS121 BK 1005HS241 BK 1005HS431 BK 1005HS601 BK 1005HS102	BK 1608HW241 BK 1608HW431 BK 1608HW601 BK 1608TS431 BK 1608TS601 BK 1608TS102 BK 1608HS121 BK 1608HS241 BK 1608HS601 BK 1608HS102	BK 2125HS431 BK 2125HS601 BK 2125HS102		
	~1500mA		BK 1005HS100 BK 1005HS330 BK 1005HS680 BK 1005HS800 BKP 1005HS121 BKP 1005HS221	BK 1608HW121 BK 1608HS220 BK 1608HS330 BK 1608HS470 BK 1608HS600 BK 1608HS800 BKP 1608HS181 BKP 1608HS271 BKP 1608HS391	BK 2125HS150 BK 2125HS220 BK 2125HS330 BK 2125HS470 BK 2125HS750 BK 2125HS101 BK 2125HS121 BK 2125HS241		
	1500mA~		BK 1005HS100 BK 1005HS330 BK 1005HS680	BKP 1608HS330 BKP 1608HS600 BKP 1608HS101 BKP 1608HS121 FBMJ1608HS280NT	BK 2125HS330 BKP 2125HS600 BKP 2125HS101 BKP 2125HS221 BKP 2125HS331 FBMJ2125HS250NT FBMJ2125HS420-T	FBMJ3216HS480NT FBMJ3216HS800-T	FBMJ4516HS720NT FBMJ4516HS111-T FBMJ4516HM560NT FBMJ4516HM900-T
<p>Normal.</p> <p>20MHz以上で急峻に増大するZ特性により、100MHz~300MHz帯の輻射ノイズに適用</p> <p>Increases the Z characteristic sharply above 20MHz and is applicable for radiated noise in the 100MHz-300MHz range.</p> <p>FBMJ、FBMHシリーズは、大電流・低Rdcタイプ (Max 1.5~6A)</p> <p>FBMJ, FBMH series be a large current and low Rdc type. (Max 1.5~6A)</p>	~500mA	BK 0603HM600 BK 0603HM121 BK 0603HM241 BK 0603HM471	BK 1005HM121 BK 1005HM241 BK 1005HM471 BK 1005HM601 BK 1005HM102 BK 1005LM182	BK 1608HM121 BK 1608HM241 BK 1608HM471 BK 1608HM601 BK 1608HM102 BK 1608LM751 BK 1608LM152 BK 1608LM182 BK 1608LM252 FBMH1608HM102-T	BK 2125HM471 BK 2125HM601 BK 2125HM102 BK 2125LM751 BK 2125LM152 BK 2125LM182 BK 2125LM252		
	~1500mA		BKP 1005HM121 BKP 1005HM221	FBMH1608HM221-T FBMH1608HM331-T FBMH1608HM471-T FBMH1608HM601-T	BK 2125HM121 BK 2125HM241	FBMH4516HM851NT FBMH4532HM202-T	
	1500mA~			FBMH1608HM470-T FBMH1608HM600-T FBMH1608HM101-T FBMH1608HM151-T FBMJ1608HM230NT	FBMH2012HM800-T FBMH2012HM121-T FBMH2012HM221-T FBMH2016HM251NT FBMH2012HM331-T FBMJ2125HM210NT FBMJ2125HM330-T	FBMH3216HM501NT FBMH3225HM601NT FBMH3225HM102NT	FBMH4532HM681-T FBMH4525HM102NT FBMH4532HM132-T FBMH4525HM162NT
<p>High-Q</p> <p>[LL series]:Zの立ち上がりを高周波域とした設計により、200MHz~500MHzのノイズ対策に適用</p> <p>Designed as a noise countmeasure for the 200MHz-500MHz range where the rise of the Z component is in the high frequency area.</p> <p>[LM series]:200MHz近傍のノイズ対策に最適。より高い減衰効果</p> <p>Intended for noise suppression around 200MHz.Effectively increases attenuation.</p> <p>FBMJシリーズは、大電流・低Rdcタイプ (Max 2A)</p> <p>FBMJ series be a large current and low Rdc type. (Max 2A)</p>	~500mA	BK 0603LL100 BK 0603LL220 BK 0603LL330 BK 0603LL470 BK 0603LL560 BK 0603LL121	BK 1005LL100 BK 1005LL220 BK 1005LL330 BK 1005LL470 BK 1005LL680 BK 1005LL121 BK 1005LL181 BK 1005LL241	BK 1608LL300 BK 1608LL470 BK 1608LL560 BK 1608LL680 BK 1608LL121 BK 1608LL181 BK 1608LL241 BK 1608LL331 BK 1608LL431 BK 1608LL511 BK 1608LL681 FBMH1608HL471-T FBMH1608HL601-T	BK 2125LL121 BK 2125LL241		
	~1500mA			FBMH1608HL121-T FBMH1608HL221-T FBMH1608HL331-T	BK 2125LL560		
	1500mA~			FBMH1608HL300-T FBMH1608HL600-T	FBMJ2125HL8R0NT		

積層ハイロスインダクタ

MULTILAYER FERRITE CHIP BEADS

BK SERIES



OPERATING TEMP.	-55~+125°C
-----------------	------------

*BK0603, BK1005は除く
* Except for BK0603, BK1005

特長 FEATURES

- Ag内部導体を使用した磁気シールド構造により、発熱やクロストークが小さい
- GND不要のため、パターン設計上の自由度が大きい
- ノイズ対策のため様々なバリエーションとインピーダンスをラインナップ
 - HS : XL成分を抑え、(デジタル波形のオーバーシュート等)波形品位の低下を抑制
 - HM : 20MHz以上で急峻に増大するZ特性により、100MHz~300MHz帯の輻射ノイズに適用(映像信号廻りに効果的)
 - LL : Zの立ち上がりを高周波域とした設計により、200MHz~500MHzのノイズ対策に適用
 - LM : 200MHz近傍のノイズ対策に最適。より高い減衰効果
 - HW : シリーズ中最もXL成分を抑えた設計により、波形品位低下の抑止と共に高周波域での減衰をも確保
 - TS : 直流抵抗低減化設計により、LSI電源廻りでのノイズ対策に最適

- Internal silver printed layer creates a closed circuit which acts as a magnetic shield minimizing heat generation and crosstalk.
- No need for grounding provides greater circuit design flexibility.
- Several material types and a broad range of impedance values provide noise countermeasures for various applications.
 - HS : Suppresses the XL component. Helps stop the reduction of the wave-form integrity (digital wave-form overshoot, etc.)
 - HM : Increases the Z characteristic sharply above 20MHz and is applicable for radiated noise in the 100MHz~300MHz range. Especially effective on video signal lines.
 - LL : Designed as a noise countermeasure for the 200MHz~500MHz range where the rise of the Z component is in the high frequency area.
 - LM : Intended for noise suppression around 200MHz. Effectively increases attenuation.
 - HW : The best material in the BK Series to suppress the XL component and stop the reduction of the wave-form integrity while maintaining attenuation in the high frequency area.
 - TS : Reduced DC resistance version for noise countermeasures around LSI power supplies.

用途 APPLICATIONS

- パソコン、デジタルスチルカメラ等の情報機器・デジタル機器のクロックライン、一般信号ラインに於ける高調波ノイズ対策
- パソコン、プリンタ等のインターフェイス、ハーネス接続部での輻射ノイズ及びイミュニティ対策
- ビデオ、ムービー等のAV機器に於けるノイズ対策
- PDC、PHS等の移動体通信機器の回路間の干渉防止
- 磁気シールド構造による小型化メリットを生かし、LSI電源供給ラインのノイズ防止フィルタ用途に最適(TS)

- High frequency noise countermeasure in personal computers, digital cameras and other information system products. For use on digital product clock lines and general signal lines.
- Radiated noise suppression in computer or printer interfaces and harness connectors.
- Noise suppression in video and other AV products.
- Prevents interference between circuits in cellular phones (PHS, PDC, etc.)
- Due to the closed internal circuit which acts as a magnetic shield, the TS material is extremely effective as a noise filter on LSI power supply lines where downsizing of components is needed.

形名表記法 ORDERING CODE

1 形式 BK 積層ハイロスインダクタ	3 材質記号 HW HS HM LM LL TS 材質によりインピーダンス特性が異なる	4 公称インピーダンス [Ω] 例 150 15 101 100 102 1000	5 特性 - 標準品	7 当社管理記号 △ 標準品 △=スペース
2 形状寸法 (L×W) [mm] 0603 (0201) 0.6×0.3 1005 (0402) 1.0×0.5 1608 (0603) 1.6×0.8 2125 (0805) 2.0×1.25			6 包装 T リールテーピング	



1 Type BK Multilayer Ferrite Chip Beads	3 Material HW HS HM LM LL TS Refer to impedance curves for material differences	4 Impedance [Ω] example 150 15 101 100 102 1000	5 Characteristics - Standard Products	7 Internal code △ Standard Products △=Blank Space
2 External Dimensions (L×W) [mm] 0603 (0201) 0.6×0.3 1005 (0402) 1.0×0.5 1608 (0603) 1.6×0.8 2125 (0805) 2.0×1.25			6 Packaging T Tape & Reel	

外形寸法 EXTERNAL DIMENSIONS

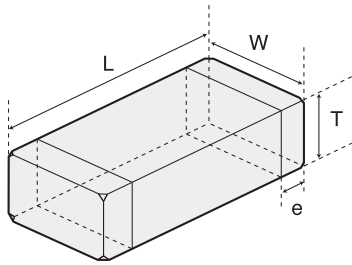

Type	L	W	T	e
BK0603 (0201)	0.60±0.03 (0.024±0.001)	0.30±0.03 (0.012±0.001)	0.30±0.03 (0.012±0.001)	0.15±0.05 (0.006±0.002)
BK1005 (0402)	1.00±0.05 (0.039±0.002)	0.50±0.05 (0.020±0.002)	0.50±0.05 (0.020±0.002)	0.25±0.10 (0.010±0.004)
BK1608 (0603)	1.6±0.15 (0.063±0.006)	0.8±0.15 (0.031±0.006)	0.8±0.15 (0.031±0.006)	0.3±0.2 (0.012±0.008)
BK2125 (0805)	2.0 ^{+0.3} _{-0.1} (0.079 ^{+0.012} _{-0.004})	1.25±0.2 (0.049±0.008)	0.85±0.2 1.25±0.2 (0.033±0.008) (0.049±0.008)	0.5±0.3 (0.020±0.012)

Unit : mm (inch)

5

FERRITE PRODUCTS

概略バリエーション AVAILABLE MATERIALS

BK0603

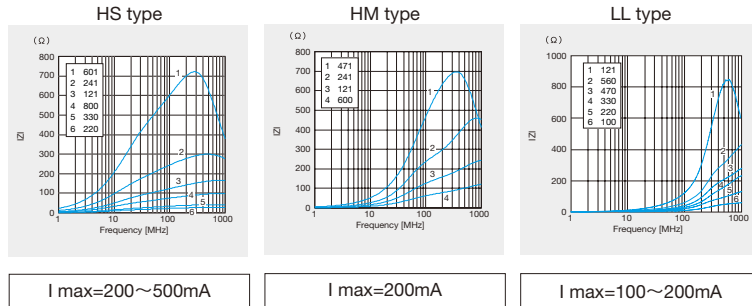

BK1005

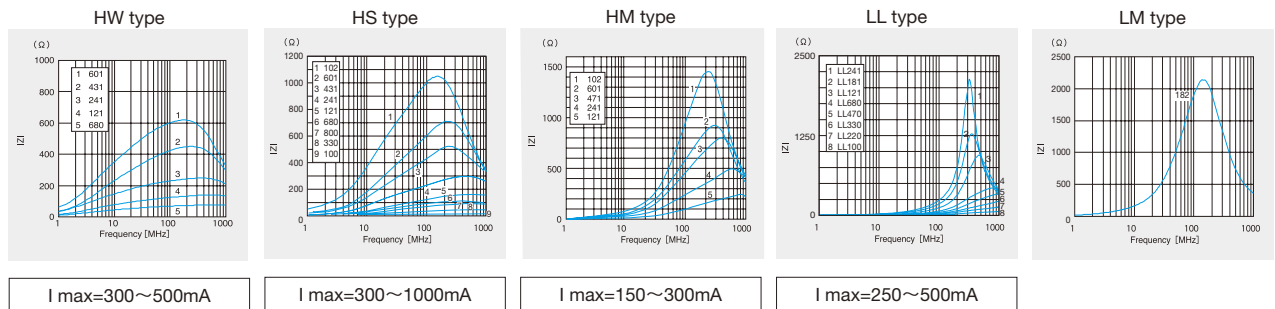

BK1608

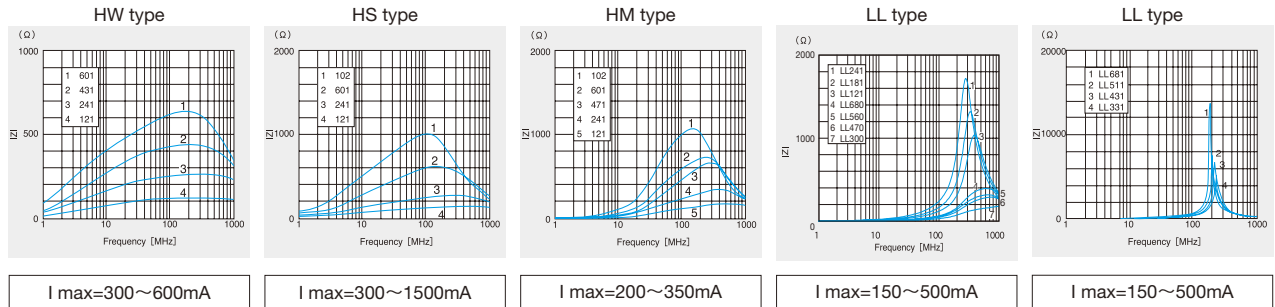

セクションガイド
Selection Guide

アイテム一覧
Part Numbers

特性図
Electrical Characteristics

梱包
Packaging

信頼性
Reliability Data

使用上の注意
Precautions



etc

BK1608

LM type

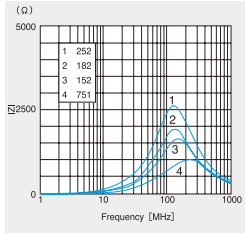

I max=200 ~ 300mA

TS type

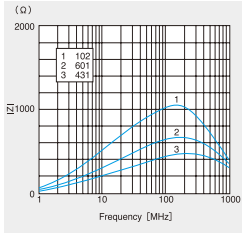

I max=300 ~ 400mA

BK2125

HS type

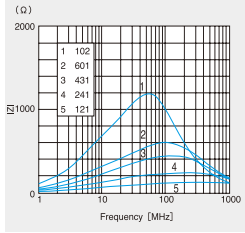

I max=300 ~ 1200mA

HM type

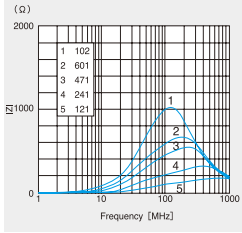

I max=400 ~ 800mA

LL type

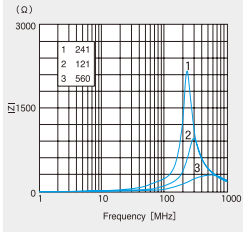

I max=300 ~ 600mA

LM type

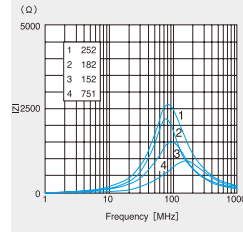

I max=200 ~ 400mA

BK0603

形名 Ordering code	EHS (Environmental Hazardous Substances)	インピーダンス Impedance [Ω] ±25%	測定周波数 Measuring frequency [MHz]	直流抵抗 DC resistance [Ω] (max.)	定格電流 Rated current [mA] (max.)	厚み Thickness [mm] (inch)
BK 0603 HS 220	RoHS	22	100	0.065	500	0.30±0.03 (0.012±0.001)
BK 0603 HS 330	RoHS	33		0.070	500	
BK 0603 HS 800	RoHS	80		0.40	200	
BK 0603 HS 121	RoHS	120		0.45	200	
BK 0603 HS 241	RoHS	240		0.65	200	
BK 0603 HS 601	RoHS	600		1.20	150	
BK 0603 HM 600	RoHS	60		0.25	200	
BK 0603 HM 121	RoHS	120		0.40	200	
BK 0603 HM 241	RoHS	240		0.80	200	
BK 0603 HM 471	RoHS	470		1.05	100	
BK 0603 LL 100	RoHS	10		0.25	200	
BK 0603 LL 220	RoHS	22		0.45	200	
BK 0603 LL 330	RoHS	33		0.55	150	
BK 0603 LL 470	RoHS	47		0.70	150	
BK 0603 LL 560	RoHS	56		1.00	100	
BK 0603 LL 121	RoHS	120		1.50	100	

BK1005

形名 Ordering code	EHS (Environmental Hazardous Substances)	インピーダンス Impedance [Ω] ±25%	測定周波数 Measuring frequency [MHz]	直流抵抗 DC resistance [Ω] (max.)	定格電流 Rated current [mA] (max.)	厚み Thickness [mm] (inch)
BK 1005 HW 680	RoHS	68	100	0.17	500	0.50±0.05 (0.020±0.002)
BK 1005 HW 121	RoHS	120		0.24	450	
BK 1005 HW 241	RoHS	240		0.31	400	
BK 1005 HW 431	RoHS	430		0.50	350	
BK 1005 HW 601	RoHS	600		0.60	300	
BK 1005 HS 100	RoHS	10		0.03	1000	
BK 1005 HS 330	RoHS	33		0.06	700	
BK 1005 HS 680	RoHS	68		0.10	700	
BK 1005 HS 800	RoHS	80		0.10	700	
BK 1005 HS 121	RoHS	120		0.20	500	
BK 1005 HS 241	RoHS	240		0.30	400	
BK 1005 HS 431	RoHS	430		0.45	350	
BK 1005 HS 601	RoHS	600		0.55	300	
BK 1005 HS 102	RoHS	1000		0.58	300	
BK 1005 HM 121	RoHS	120		0.18	300	
BK 1005 HM 241	RoHS	240		0.30	300	
BK 1005 HM 471	RoHS	470		0.45	250	
BK 1005 HM 601	RoHS	600		0.50	250	
BK 1005 HM 102	RoHS	1000		0.70	150	
BK 1005 LL 100	RoHS	10		0.11	500	
BK 1005 LL 220	RoHS	22		0.18	400	
BK 1005 LL 330	RoHS	33		0.25	400	
BK 1005 LL 470	RoHS	47		0.33	350	
BK 1005 LL 680	RoHS	68		0.31	400	
BK 1005 LL 121	RoHS	120		0.45	350	
BK 1005 LL 181	RoHS	180		0.50	300	
BK 1005 LL 241	RoHS	240		0.70	250	
BK 1005 LM 182	RoHS	1800		0.90	120	

BK1608

形名 Ordering code	EHS (Environmental Hazardous Substances)	インピーダンス Impedance [Ω] ± 25%	測定周波数 Measuring frequency [MHz]	直流抵抗 DC resistance [Ω] (max.)	定格電流 Rated current [mA] (max.)	厚み Thickness [mm] (inch)
BK 1608 HW 121	RoHS	120	100	0.15	600	0.80 ± 0.15 (0.031 ± 0.006)
BK 1608 HW 241	RoHS	240		0.25	450	
BK 1608 HW 431	RoHS	430		0.30	400	
BK 1608 HW 601	RoHS	600		0.40	300	
BK 1608 HS 220	RoHS	22		0.05	1500	
BK 1608 HS 330	RoHS	33		0.08	1200	
BK 1608 HS 470	RoHS	47		0.10	900	
BK 1608 HS 600	RoHS	60		0.10	800	
BK 1608 HS 800	RoHS	80		0.10	600	
BK 1608 HS 121	RoHS	120		0.18	500	
BK 1608 HS 241	RoHS	240		0.25	400	
BK 1608 HS 601	RoHS	600		0.45	350	
BK 1608 HS 102	RoHS	1000		0.60	300	
BK 1608 HM 121	RoHS	120		0.20	350	
BK 1608 HM 241	RoHS	240		0.35	300	
BK 1608 HM 471	RoHS	470		0.45	250	
BK 1608 HM 601	RoHS	600		0.60	250	
BK 1608 HM 102	RoHS	1000		0.70	200	
BK 1608 LL 300	RoHS	30		0.20	500	
BK 1608 LL 470	RoHS	47		0.30	400	
BK 1608 LL 560	RoHS	56		0.30	400	
BK 1608 LL 680	RoHS	68		0.35	300	
BK 1608 LL 121	RoHS	120		0.50	300	
BK 1608 LL 181	RoHS	180		0.65	250	
BK 1608 LL 241	RoHS	240		0.80	250	
BK 1608 LL 331	RoHS	330		0.85	200	
BK 1608 LL 431	RoHS	430		0.85	200	
BK 1608 LL 511	RoHS	510		0.90	200	
BK 1608 LL 681	RoHS	680		1.00	150	
BK 1608 LM 751	RoHS	750		0.60	300	
BK 1608 LM 152	RoHS	1500		0.75	250	
BK 1608 LM 182	RoHS	1800		0.85	200	
BK 1608 LM 252	RoHS	2500		1.10	200	
BK 1608 TS 431	RoHS	430	0.21 ± 30%	400		
BK 1608 TS 601	RoHS	600	0.27 ± 30%	350		
BK 1608 TS 102	RoHS	1000	0.30 ± 30%	300		

BK2125

形名 Ordering code	EHS (Environmental Hazardous Substances)	インピーダンス Impedance [Ω] ± 25%	測定周波数 Measuring frequency [MHz]	直流抵抗 DC resistance [Ω] (max.)	定格電流 Rated current [mA] (max.)	厚み Thickness [mm] (inch)
BK 2125 HS 150	RoHS	15	100	0.05	1200	0.85 ± 0.2 (0.033 ± 0.008)
BK 2125 HS 220	RoHS	22		0.05	1200	
BK 2125 HS 330	RoHS	33		0.05	1200	
BK 2125 HS 470	RoHS	47		0.05	1000	
BK 2125 HS 750	RoHS	75		0.10	1000	
BK 2125 HS 101	RoHS	100		0.10	900	
BK 2125 HS 121	RoHS	120		0.15	800	
BK 2125 HS 241	RoHS	240		0.20	600	
BK 2125 HS 431	RoHS	430		0.25	500	
BK 2125 HS 601	RoHS	600		0.30	500	
BK 2125 HS 102	RoHS	1000		0.40	300	
BK 2125 HS 121	RoHS	120		0.15	800	
BK 2125 HM 241	RoHS	240		0.20	600	
BK 2125 HM 471	RoHS	470		0.25	500	
BK 2125 HM 601	RoHS	600		0.25	500	
BK 2125 HM 102	RoHS	1000		0.35	400	
BK 2125 LL 560	RoHS	56		0.20	600	
BK 2125 LL 121	RoHS	120		0.30	400	
BK 2125 LL 241	RoHS	240		0.35	300	
BK 2125 LM 751	RoHS	750		0.30	400	
BK 2125 LM 152	RoHS	1500		0.35	400	
BK 2125 LM 182	RoHS	1800		0.45	300	
BK 2125 LM 252	RoHS	2500		0.75	200	

BK0603

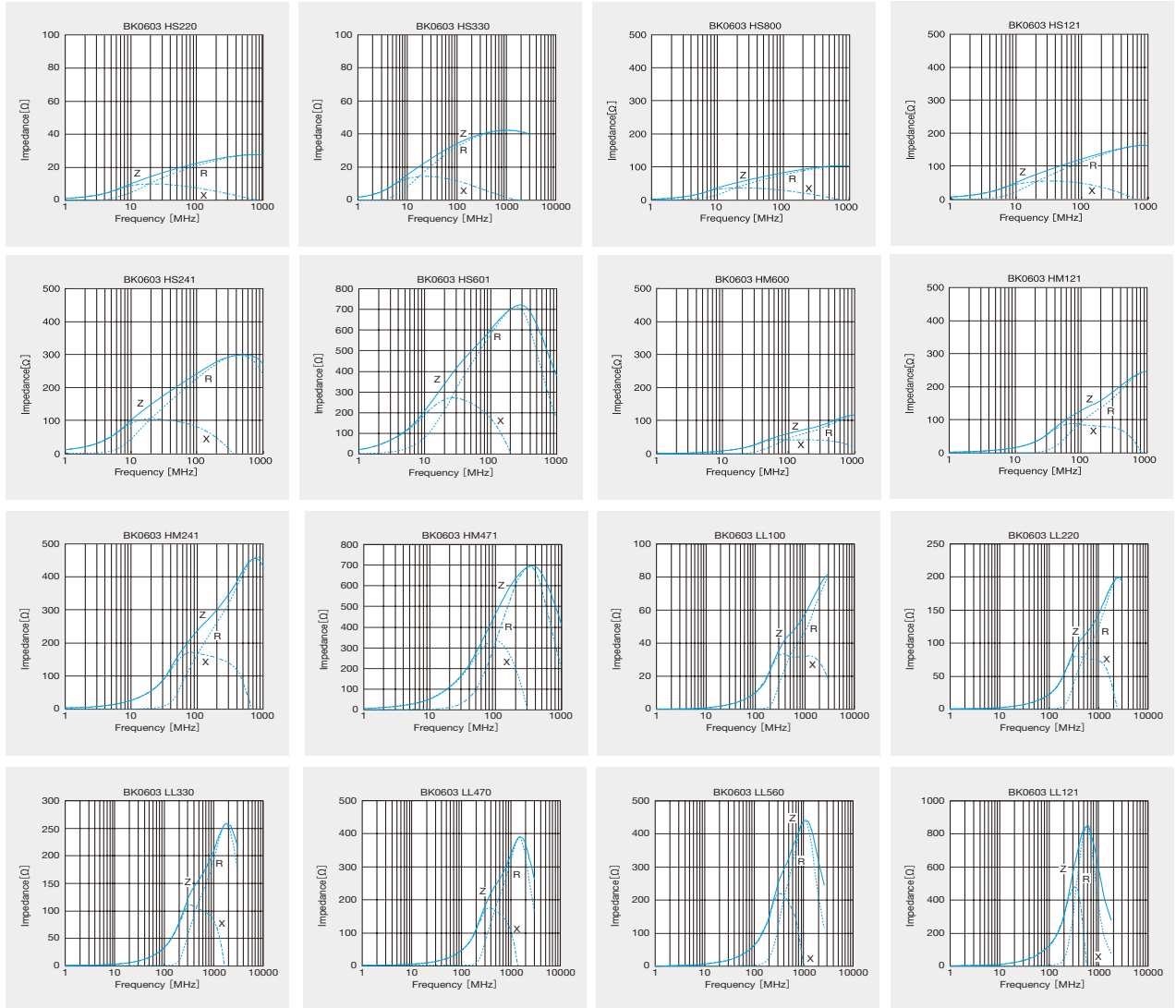

BK1005

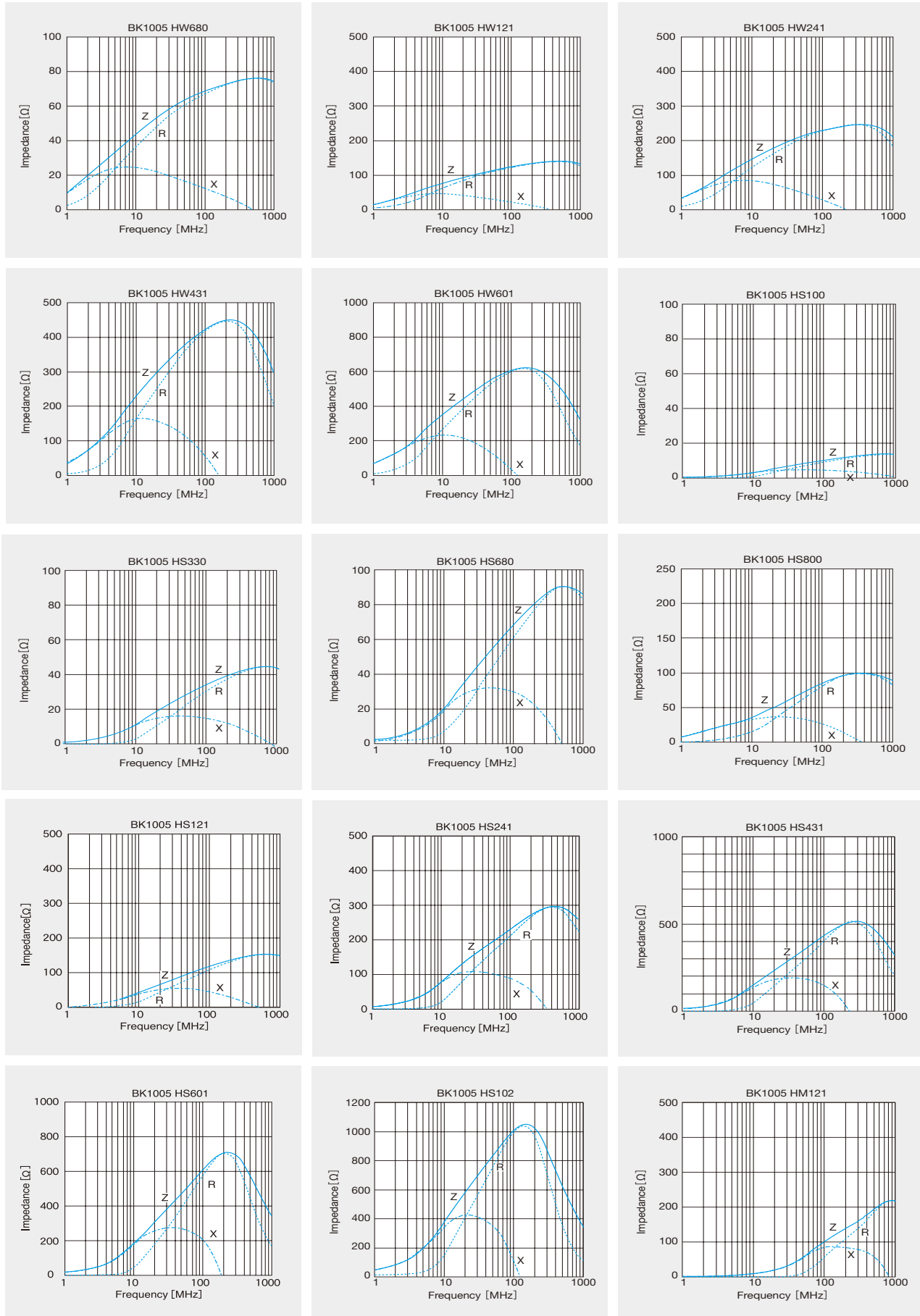

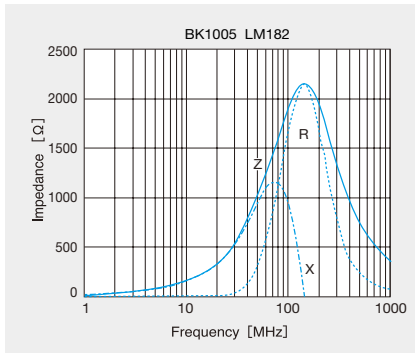
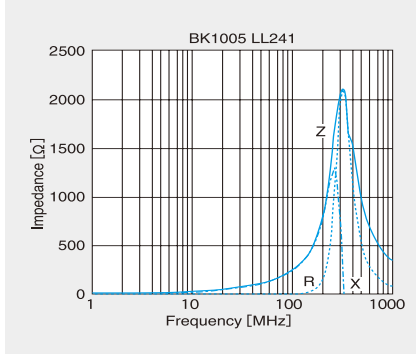
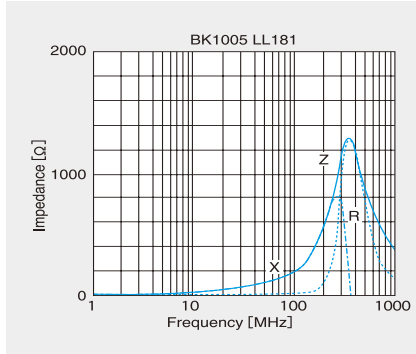
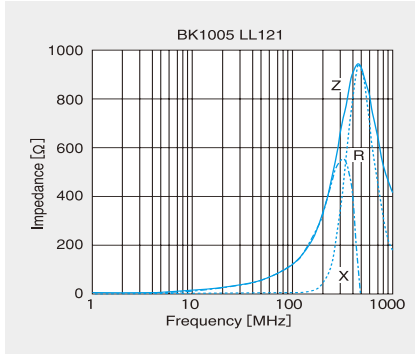
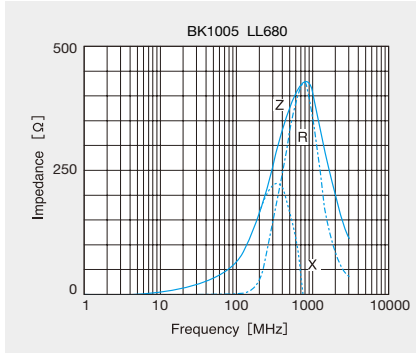
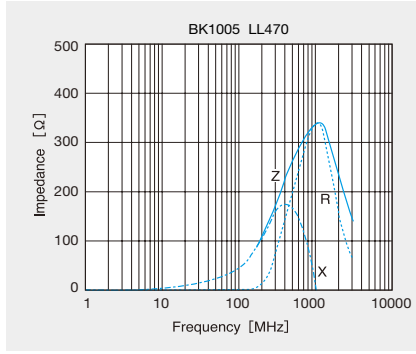
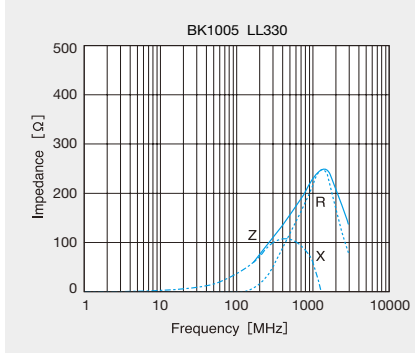
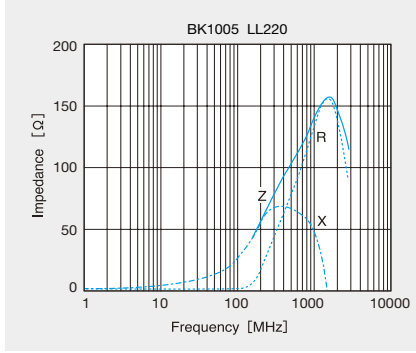
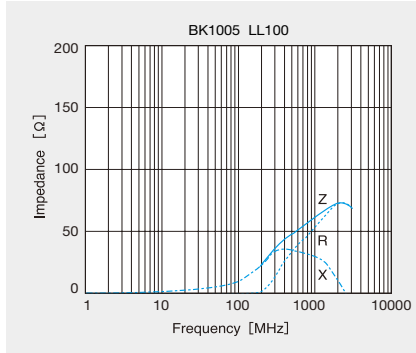
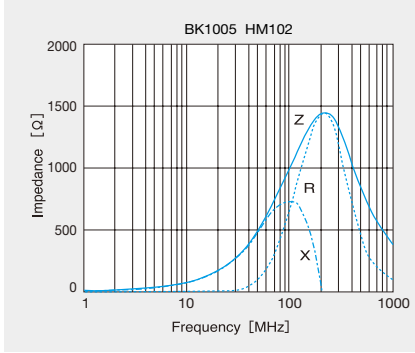
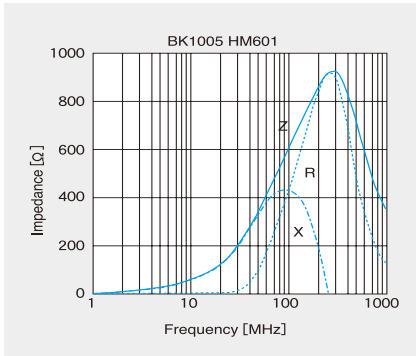
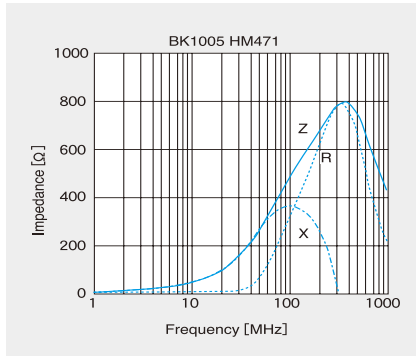
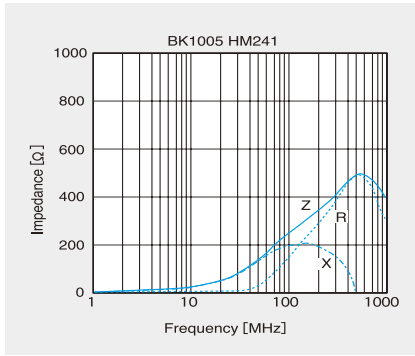

BK1608

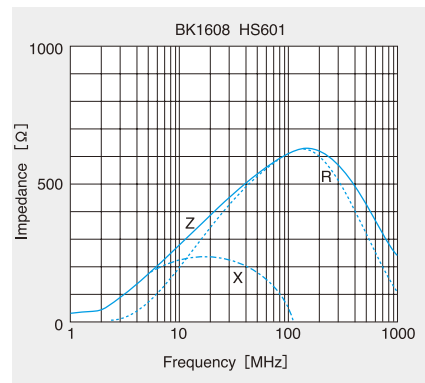
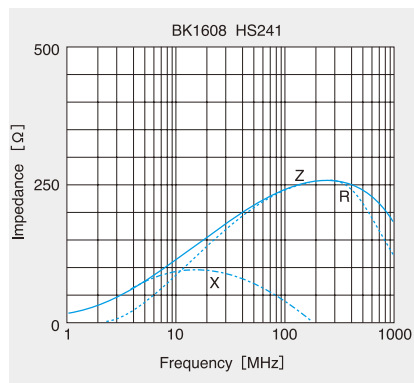
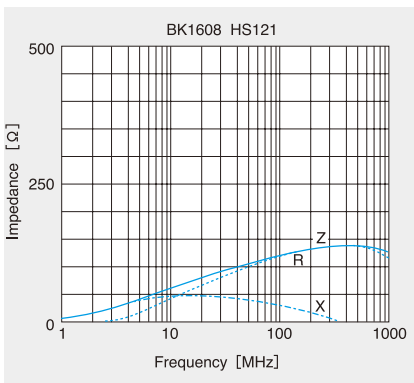
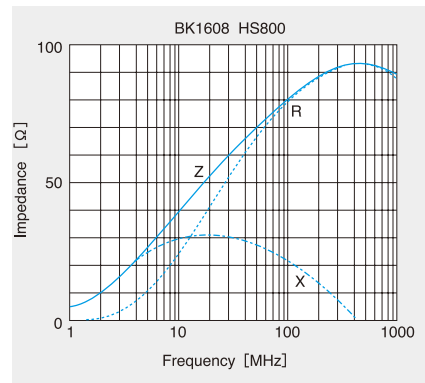
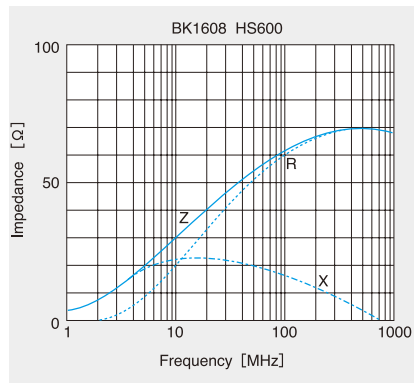
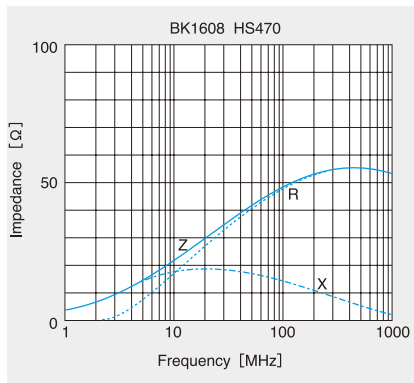
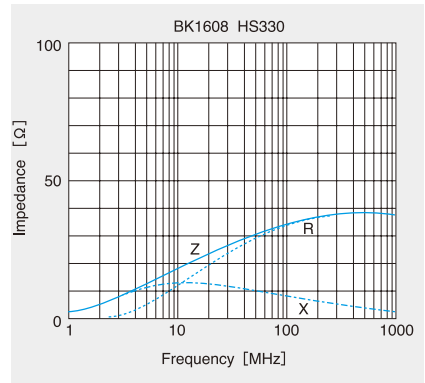
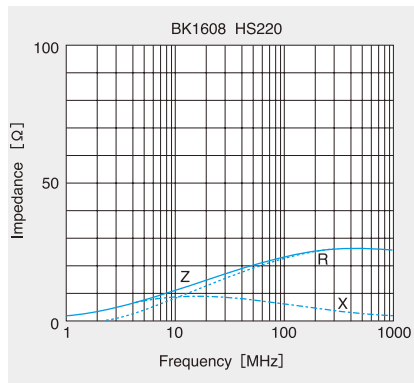
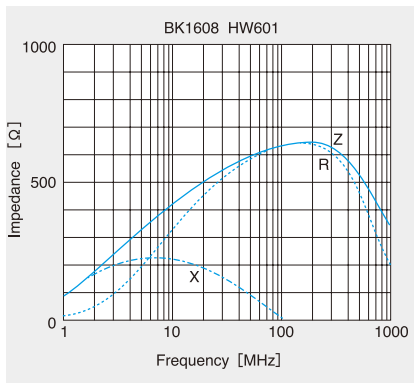
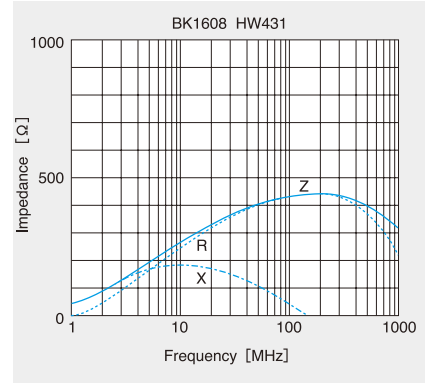
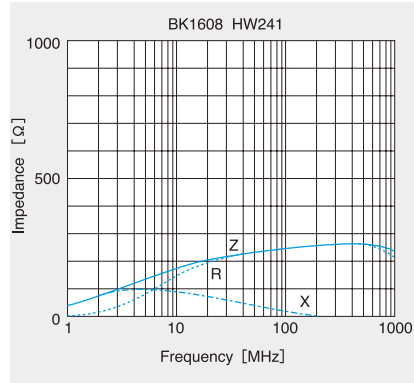
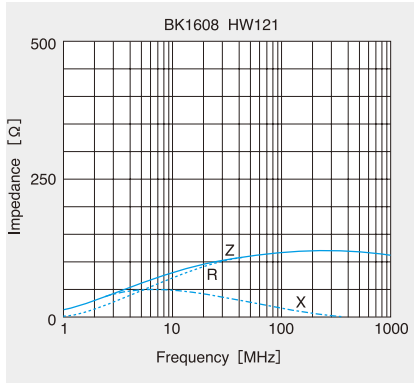

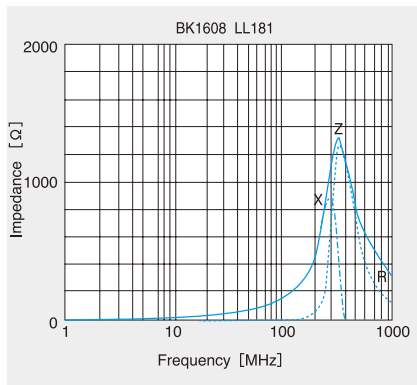
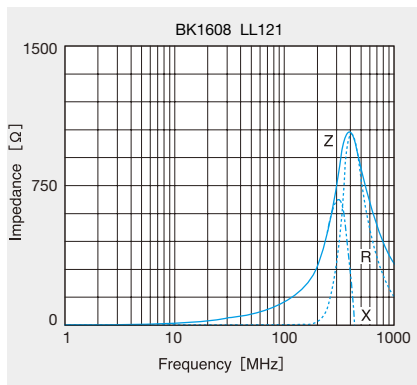
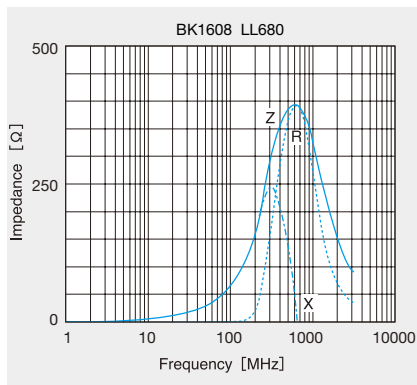
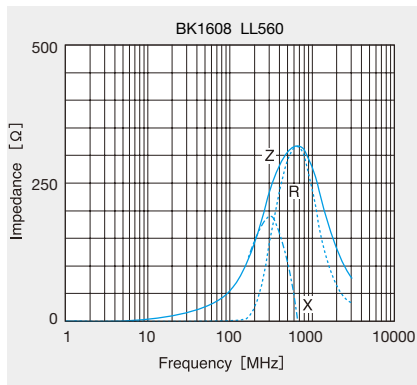
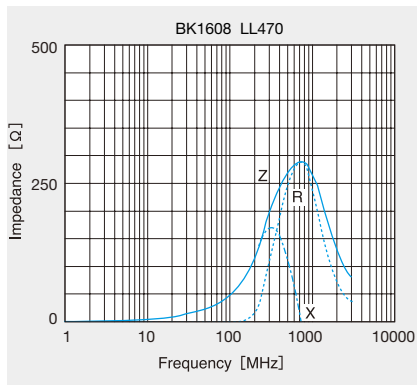
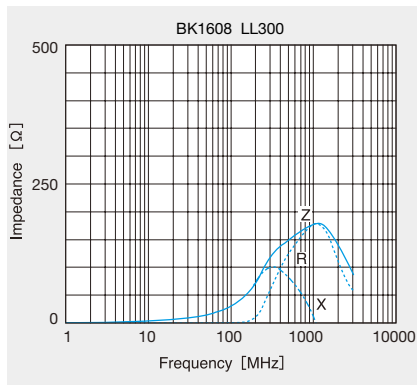
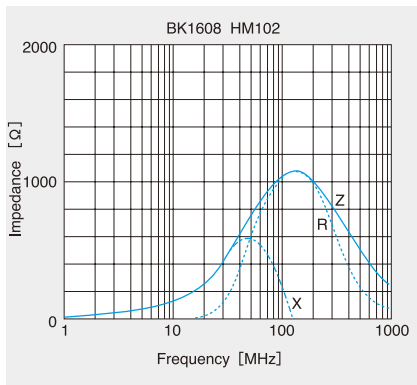
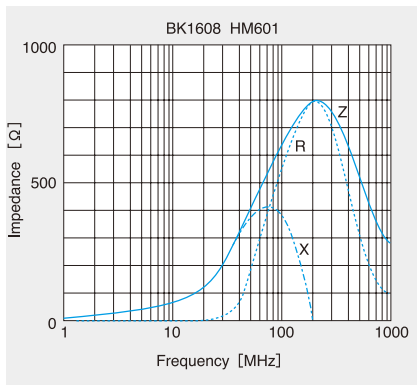
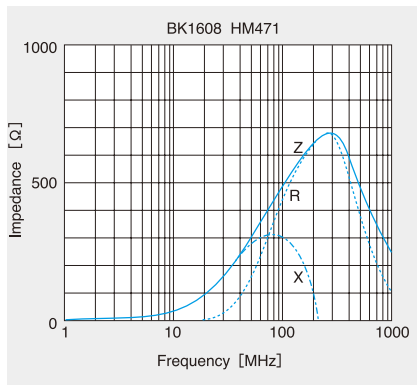
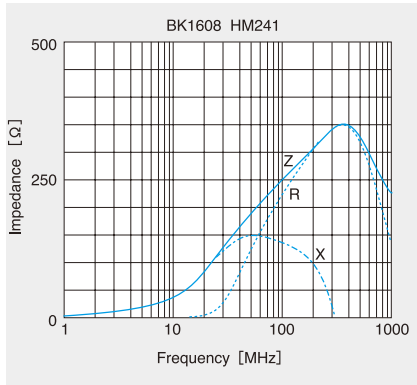
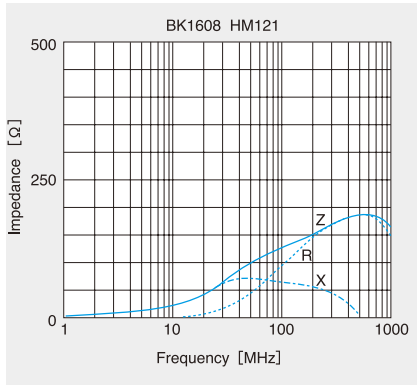
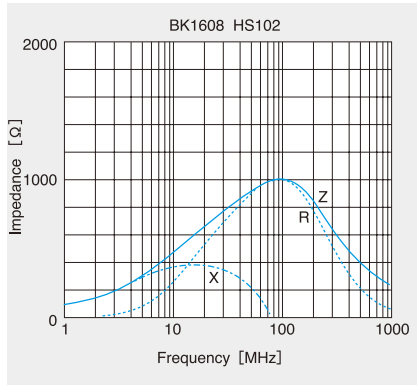

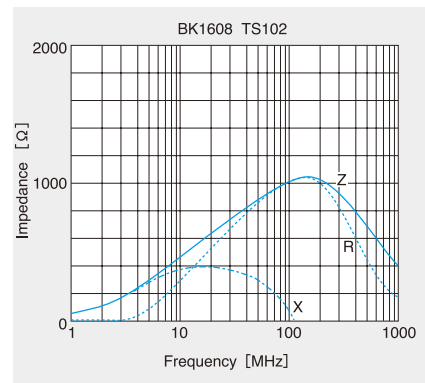
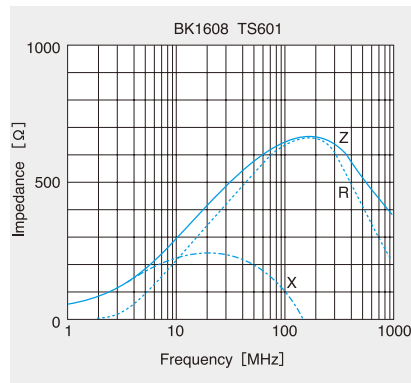
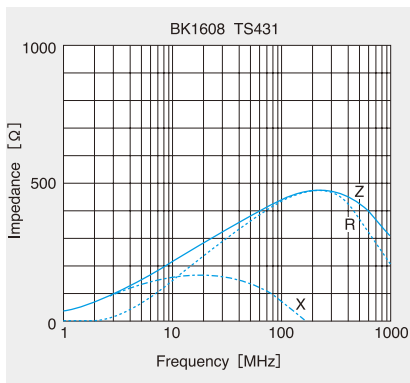
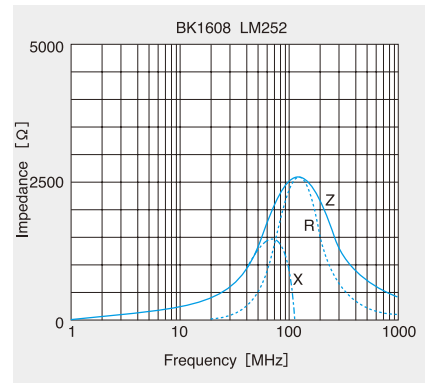
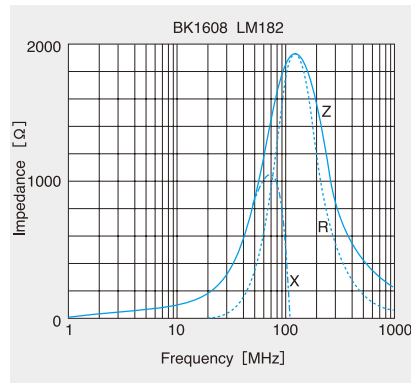
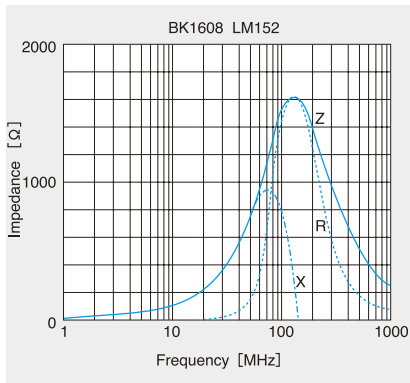
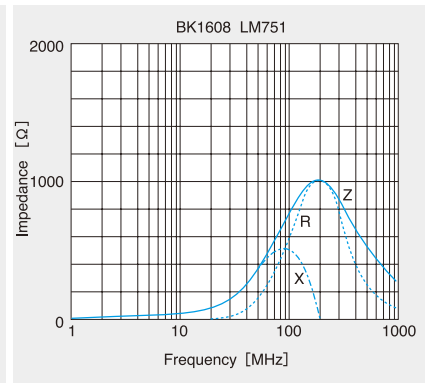
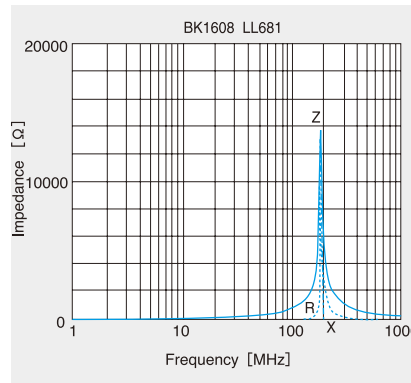
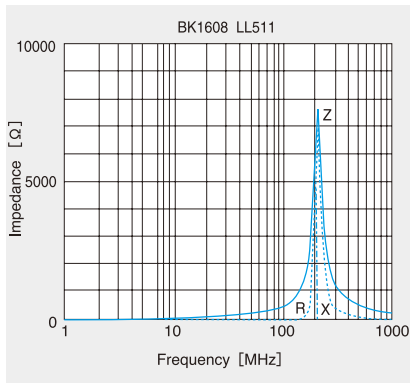
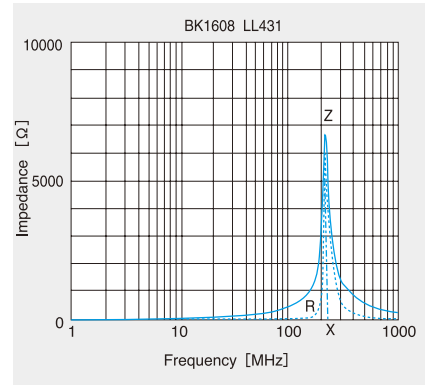
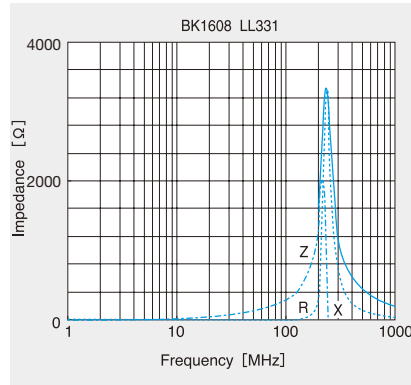
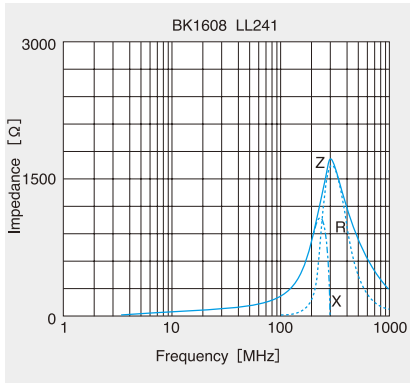

BK2125

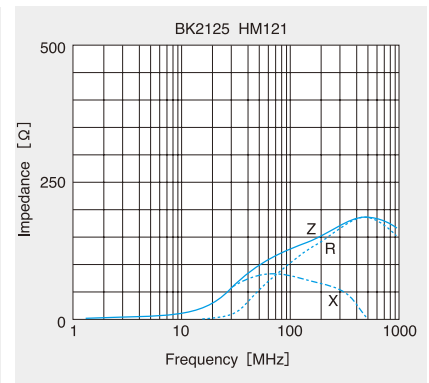
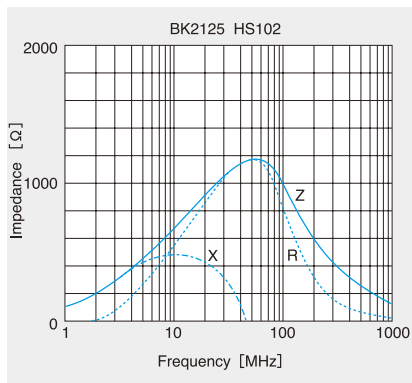
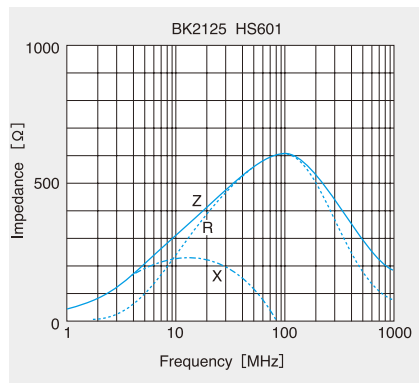
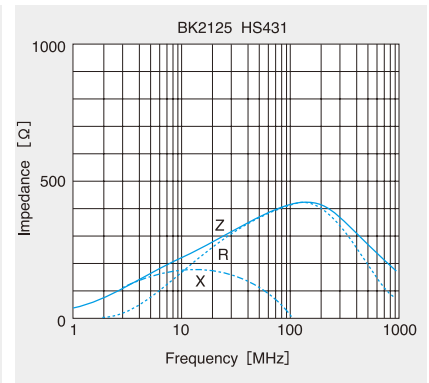
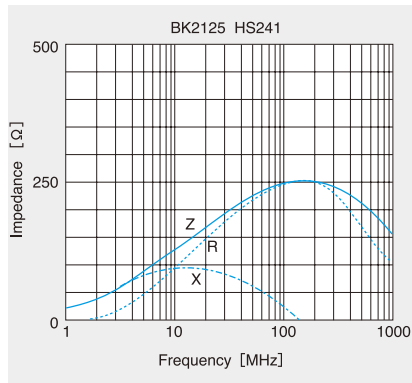
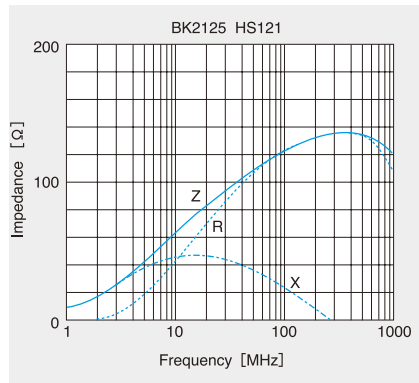
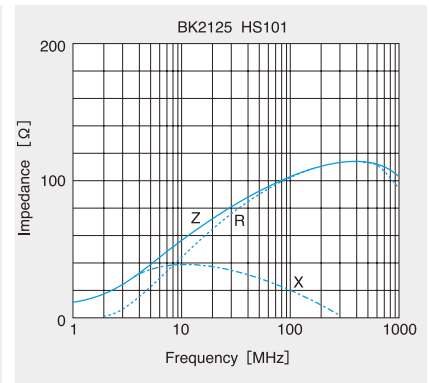
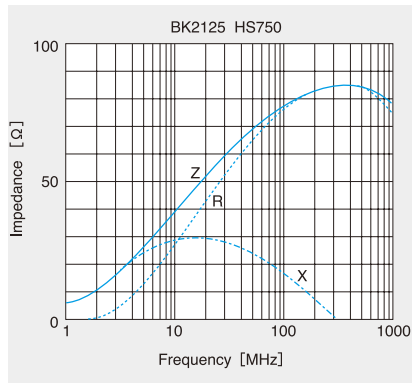
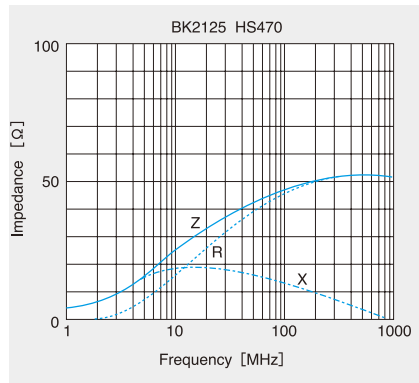
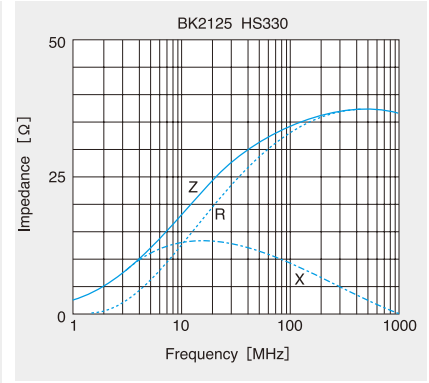
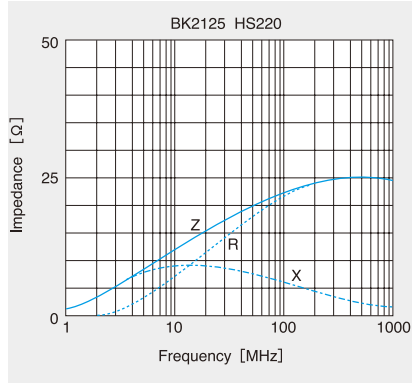
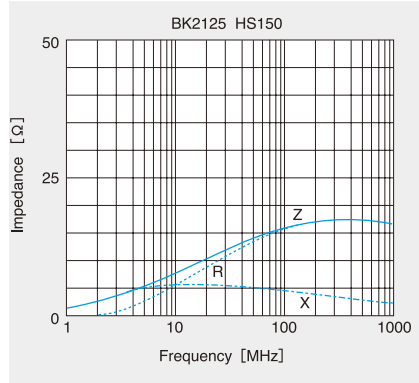

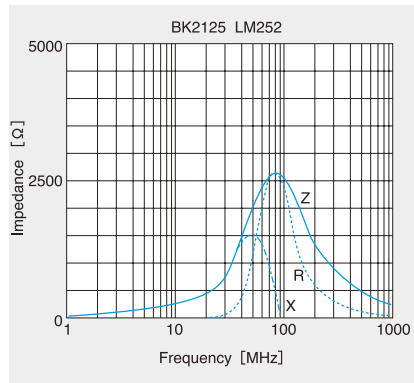
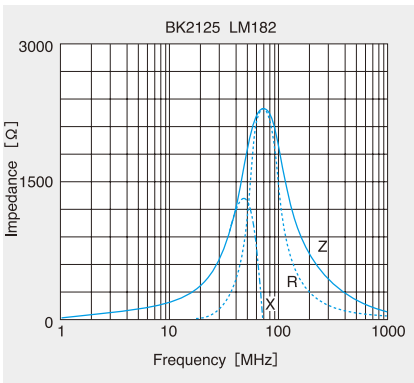
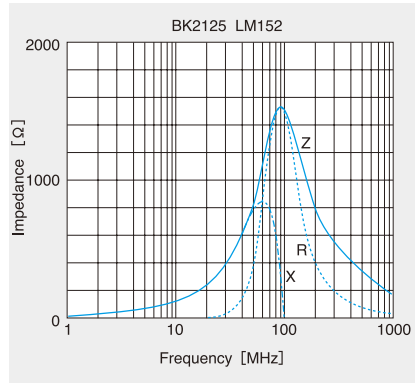
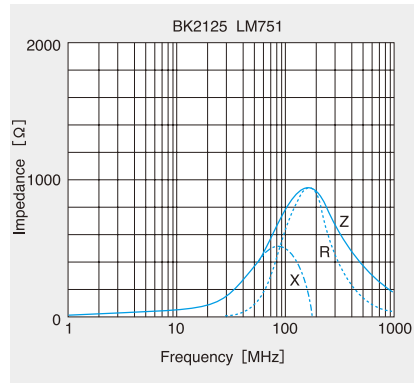
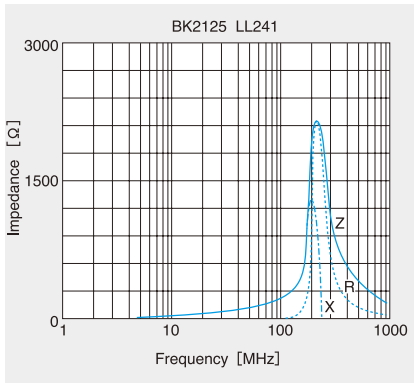
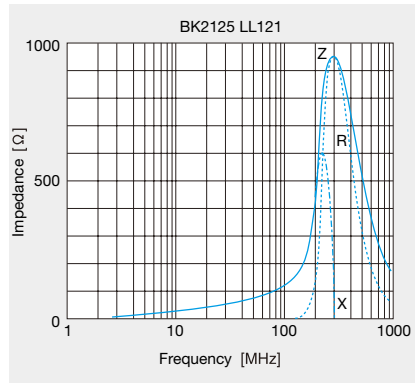
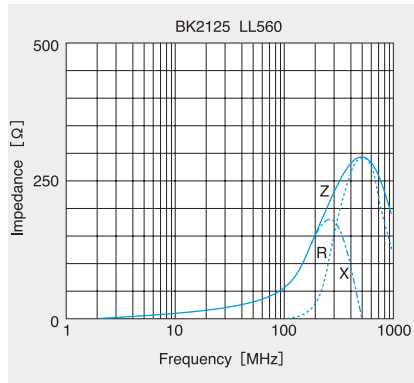
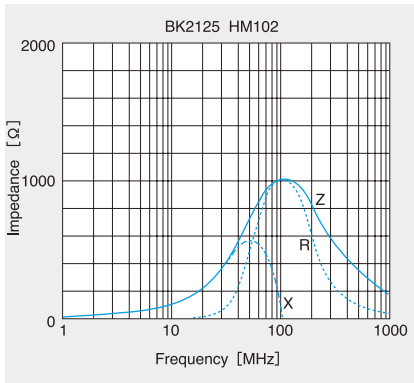
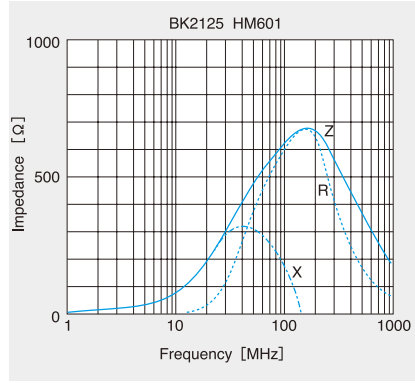
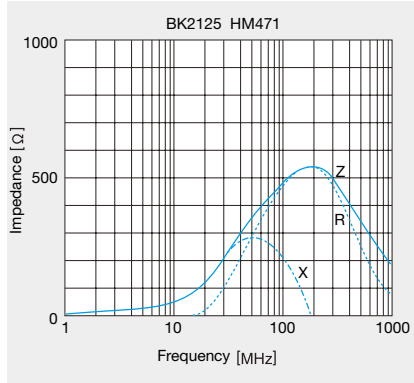
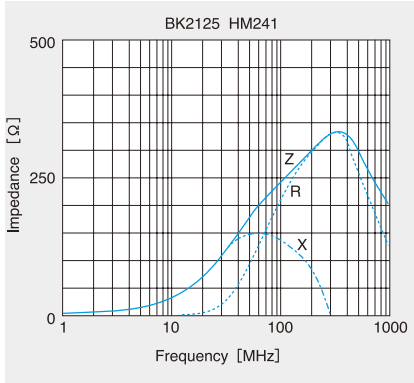

電源用積層ハイロスインダクタ MULTILAYER FERRITE CHIP BEADS (FOR POWER SUPPLY LINES) BK SERIES P TYPE



OPERATING TEMP.	-55~+85°C
-----------------	-----------

* BKP1005を除く
* Except for BKP1005

特長 FEATURES

- ・グリーンシート及び印刷技術の高度化により実現された低Rdcが、低消費電力やバッテリーの長寿命化を達成します。
- ・GND不要のため、パターン設計上の自由度が大きい。
- HS : XL成分を抑え、(デジタル波形のオーバーシュート等)波形品位の低下を抑制
- HM : 20MHz以上で急峻に増大するZ特性により、100MHz~300MHz帯の輻射ノイズに適用(映像信号廻りに効果的)

- ・ Low Rdc value brings about low power dissipation and extending the life of batteries. That stands on the high advanced green sheet and printing technologies.
- ・ No need for grounding provides greater circuit design.
- HS : Suppresses the XL component. Helps stop the reduction of the wave-form integrity (digital wave-form overshoot, etc.)
- HM : Increases the Z characteristic sharply above 20MHz and is applicable for radiated noise in the 100MHz~300MHz range. Especially effective on video signal lines.

用途 APPLICATIONS

- ・パソコンや情報機器DC電源ラインにおける、高周波ノイズ対策。
- ・USBやIEEE1394などのインターフェイスラインでのノイズ対策。
- ・PDC、PHSやPDAなど携帯機器の回路間の相互干渉防止。

- ・ High frequency noise debug on the DC power supply line in personal computers and other information system products.
- ・ Noise suppression in USB and IEEE1394 interface.
- ・ Prevents interference between circuits in mobile systems(PDC, PHS, PDA)

形名表記法 ORDERING CODE

<p>1</p> <p>形式</p> <p>BKP 電源用積層ハイロスインダクタ</p>	<p>3</p> <p>材質記号</p> <table border="1"> <tr> <td>HS</td> <td>材質によりインピーダンス特性が異なる</td> </tr> <tr> <td>HM</td> <td></td> </tr> </table>	HS	材質によりインピーダンス特性が異なる	HM		<p>4</p> <p>公称インピーダンス [Ω]</p> <table border="1"> <tr> <td>例</td> <td></td> </tr> <tr> <td>330</td> <td>33</td> </tr> <tr> <td>101</td> <td>100</td> </tr> <tr> <td>391</td> <td>390</td> </tr> </table>	例		330	33	101	100	391	390	<p>5</p> <p>特性</p> <table border="1"> <tr> <td>-</td> <td>標準品</td> </tr> </table>	-	標準品	<p>7</p> <p>当社管理記号</p> <table border="1"> <tr> <td>△</td> <td>標準品</td> </tr> <tr> <td colspan="2">△=スペース</td> </tr> </table>	△	標準品	△=スペース	
HS	材質によりインピーダンス特性が異なる																					
HM																						
例																						
330	33																					
101	100																					
391	390																					
-	標準品																					
△	標準品																					
△=スペース																						
<p>2</p> <p>形状寸法 (L×W) [mm]</p> <table border="1"> <tr> <td>1005(0402)</td> <td>1.0×0.5</td> </tr> <tr> <td>1608(0603)</td> <td>1.6×0.8</td> </tr> <tr> <td>2125(0805)</td> <td>2.0×1.25</td> </tr> </table>	1005(0402)	1.0×0.5	1608(0603)	1.6×0.8	2125(0805)	2.0×1.25			<p>6</p> <p>包装</p> <table border="1"> <tr> <td>T</td> <td>リールテーピング</td> </tr> </table>	T	リールテーピング											
1005(0402)	1.0×0.5																					
1608(0603)	1.6×0.8																					
2125(0805)	2.0×1.25																					
T	リールテーピング																					



<p>1</p> <p>Type</p> <p>BKP Multilayer Ferrite Chip Beads (For Power Supply Lines)</p>	<p>3</p> <p>Material</p> <table border="1"> <tr> <td>HS</td> <td>Refer to impedance Cverves for material differences</td> </tr> <tr> <td>HM</td> <td></td> </tr> </table>	HS	Refer to impedance Cverves for material differences	HM		<p>4</p> <p>Impedance [Ω]</p> <table border="1"> <tr> <td>example</td> <td></td> </tr> <tr> <td>330</td> <td>33</td> </tr> <tr> <td>101</td> <td>100</td> </tr> <tr> <td>391</td> <td>390</td> </tr> </table>	example		330	33	101	100	391	390	<p>5</p> <p>Characteristics</p> <table border="1"> <tr> <td>-</td> <td>Standard Products</td> </tr> </table>	-	Standard Products	<p>7</p> <p>Internal code</p> <table border="1"> <tr> <td>△</td> <td>Standard Products</td> </tr> <tr> <td colspan="2">△=Blank Space</td> </tr> </table>	△	Standard Products	△=Blank Space	
HS	Refer to impedance Cverves for material differences																					
HM																						
example																						
330	33																					
101	100																					
391	390																					
-	Standard Products																					
△	Standard Products																					
△=Blank Space																						
<p>2</p> <p>External Dimensions (L×W) [mm]</p> <table border="1"> <tr> <td>1005(0402)</td> <td>1.0×0.5</td> </tr> <tr> <td>1608(0603)</td> <td>1.6×0.8</td> </tr> <tr> <td>2125(0805)</td> <td>2.0×1.25</td> </tr> </table>	1005(0402)	1.0×0.5	1608(0603)	1.6×0.8	2125(0805)	2.0×1.25			<p>6</p> <p>Packaging</p> <table border="1"> <tr> <td>T</td> <td>Tape & Reel</td> </tr> </table>	T	Tape & Reel											
1005(0402)	1.0×0.5																					
1608(0603)	1.6×0.8																					
2125(0805)	2.0×1.25																					
T	Tape & Reel																					

外形寸法 EXTERNAL DIMENSIONS

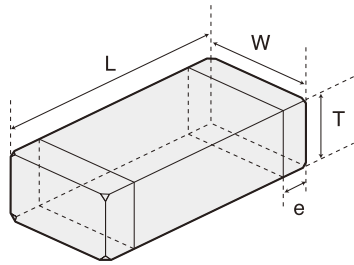

Type	L	W	T	e
BKP1005 (0402)	1.00±0.05 (0.039±0.002)	0.50±0.05 (0.020±0.002)	0.50±0.05 (0.020±0.002)	0.25±0.10 (0.010±0.004)
BKP1608 (0603)	1.6±0.15 (0.063±0.006)	0.8±0.15 (0.031±0.006)	0.8±0.15 (0.031±0.006)	0.3±0.2 (0.012±0.008)
BKP2125 (0805)	2.0 ^{+0.3} _{-0.1} (0.079 ^{+0.012} _{-0.004})	1.25±0.2 (0.049±0.008)	0.85±0.2 (0.033±0.008)	0.5±0.3 (0.020±0.012)

Unit : mm (inch)

概略バリエーション AVAILABLE MATERIALS

BKP1005

HS type

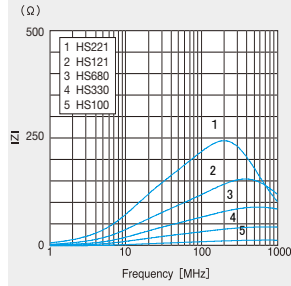

I max=0.8~2.0A

HM type

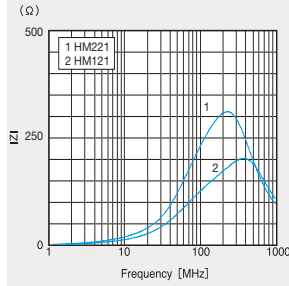

I max=0.9~1.1A

BKP1608

HS type

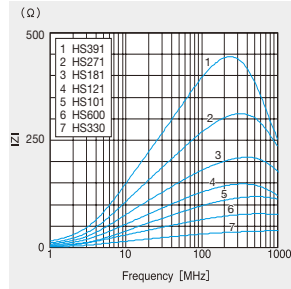

I max=1~3A

BKP2125

HS type

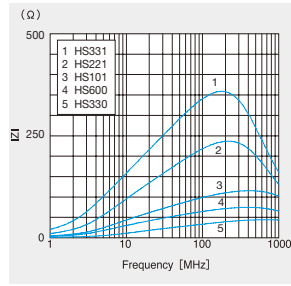

I max=1.5~4A

セクションガイド
Selection Guide



etc

アイテム一覧
Part Numbers



特性図
Electrical Characteristics



梱包
Packaging



信頼性
Reliability Data



使用上の注意
Precautions



BKP1005

形名 Ordering code	EHS (Environmental Hazardous Substances)	インピーダンス Impedance [Ω] ±25%	測定周波数 Measuring frequency [MHz]	直流抵抗 DC resistance [mΩ] (max.)	定格電流 Rated current [A] (max.)	厚み Thickness [mm] (inch)
BKP1005 HS 100	RoHS	10	100	30	2.0	0.50±0.05 (0.02±0.002)
BKP1005 HS 330	RoHS	33		50	1.7	
BKP1005 HS 680	RoHS	68		75	1.5	
BKP1005 HS 121	RoHS	120		140	1.0	
BKP1005 HS 221	RoHS	220		200	0.8	
BKP1005 HM 121	RoHS	120		120	1.1	
BKP1005 HM 221	RoHS	220		180	0.9	

BKP1608

形名 Ordering code	EHS (Environmental Hazardous Substances)	インピーダンス Impedance [Ω] ±25%	測定周波数 Measuring frequency [MHz]	直流抵抗 DC resistance [mΩ] (max.)	定格電流 Rated current [A] (max.)	厚み Thickness [mm] (inch)
BKP1608 HS 330	RoHS	33	100	25	3.0	0.80±0.15 (0.031±0.006)
BKP1608 HS 600	RoHS	60		40	2.5	
BKP1608 HS 101	RoHS	100		50	1.7	
BKP1608 HS 121	RoHS	120		35	2.7	
BKP1608 HS 181	RoHS	180		75	1.5	
BKP1608 HS 271	RoHS	270		110	1.2	
BKP1608 HS 391	RoHS	390		140	1.0	

BKP2125

形名 Ordering code	EHS (Environmental Hazardous Substances)	インピーダンス Impedance [Ω] ±25%	測定周波数 Measuring frequency [MHz]	直流抵抗 DC resistance [mΩ] (max.)	定格電流 Rated current [A] (max.)	厚み Thickness [mm] (inch)
BKP2125 HS 330	RoHS	33	100	20	4.0	0.85±0.2 (0.033±0.008)
BKP2125 HS 600	RoHS	60		25	3.0	
BKP2125 HS 101	RoHS	100		40	2.5	
BKP2125 HS 221	RoHS	220		50	2.0	
BKP2125 HS 331	RoHS	330		75	1.5	

BKP1005

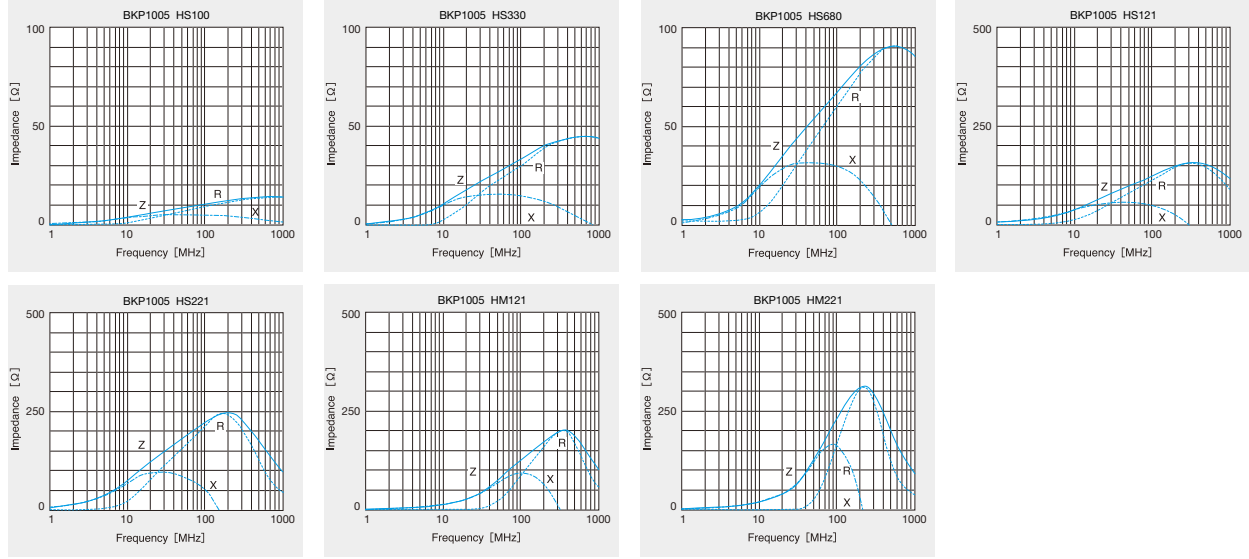

BKP1608

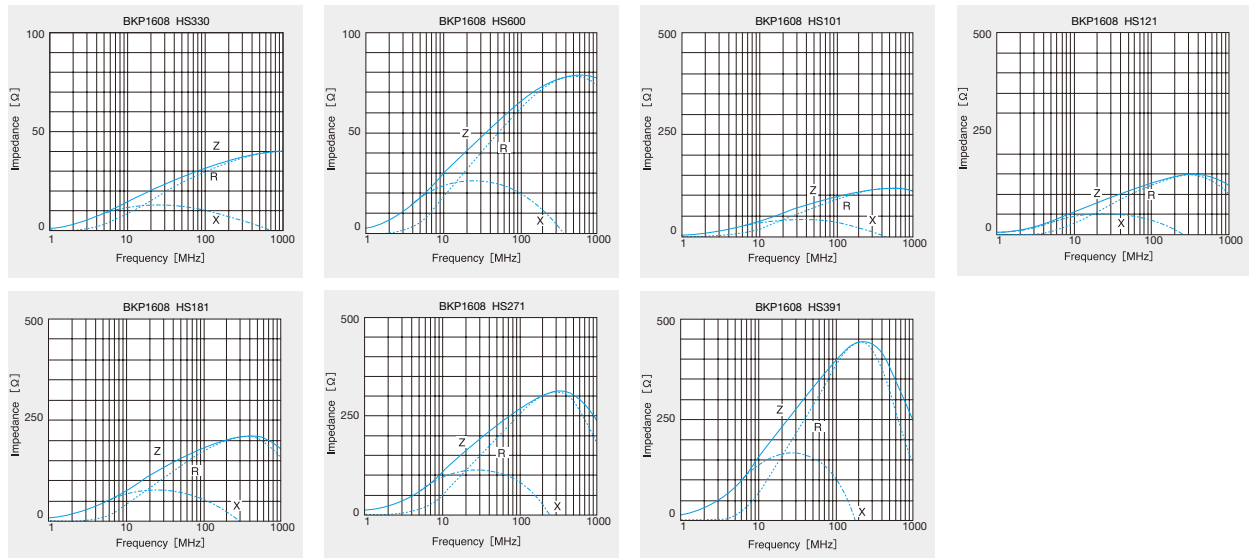

BKP2125

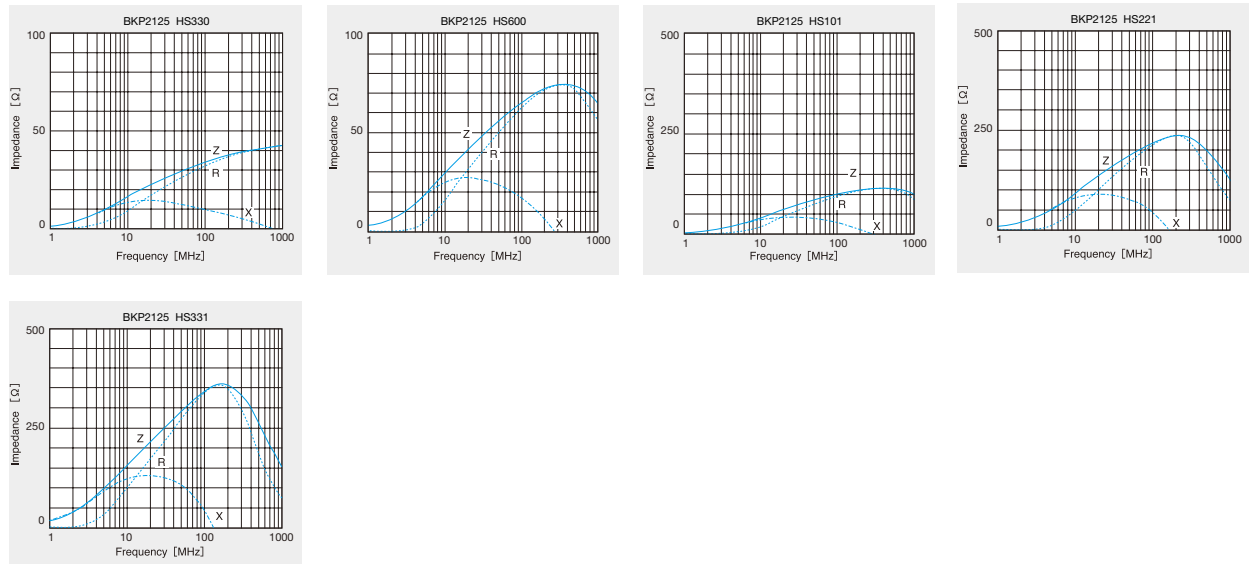

積層ハイロスインダクタアレイ

MULTILAYER FERRITE CHIP BEAD ARRAY

BK ARRAY SERIES



OPERATING TEMP.	-55~+125°C
-----------------	------------

特長 FEATURES

- ・周波数特性、インピーダンス値を幅広いバリエーションで用意しているため、各種ノイズを対策可能
- ・1チップで4ラインの対策が可能になり、より高密度、高効率な実装を実現
- ・各回路間のクロストークや、チップの発熱を極力抑制
- ・ Available in a wide range of frequency characteristics and impedance values providing excellent suppression of various noise.
- ・ 4 line action in one chip is available for mounting with higher density and efficiency.
- ・ Heat generation and crosstalk between adjacent circuits is minimized.

用途 APPLICATIONS

- ・ ノートパソコン、液晶モジュール等、小形軽量の携帯機器に於ける発生源対策・輻射ノイズ対策
- ・ インターフェイス、ハーネス接続部での輻射ノイズ対策
- ・ Radiated noise suppression in note-PC, LCD module and other portable equipment.
- ・ Radiated noise suppression in interfaces and harness connecting parts.

形名表記法 ORDERING CODE

1	3	4	5	6
形式	材質記号	公称インピーダンス [Ω]	包装	当社管理記号
BK 積層ハイロスインダクタ	4W 4S 材質によりインピーダンス特性が異なる 4M 4L	例 601 600 102 1000	-T リールテーピング	△ 標準品 △=スペース
2				
形状寸法 (L×W) [mm]				
2010 (0804) 2.0×1.0 3216 (1206) 3.2×1.6				



1	3	4	5	6
Type	Material	Nominal Impedance [Ω]	Packaging	Internal code
BK Multilayer ferrite chip beads	4W 4S Refer to impedance curves for material difference 4M 4L	example 601 600 102 1000	-T Tape&Reel	△ Standard Products △=Blank Space
2				
External Dimension (L×W) [mm]				
2010 (0804) 2.0×1.0 3216 (1206) 3.2×1.6				

外形寸法 EXTERNAL DIMENSIONS

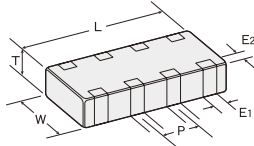

Type	Material	L	W	T	E1	E2	P
BK2010	4W, 4S, 4M (0804)	2.0±0.15 (0.079±0.006)	1.0±0.15 (0.039±0.006)	0.45±0.05 (0.018±0.002)	0.25 ^{+0.15} _{-0.1} (0.010 ^{+0.006} _{-0.004})	0.25±0.15 (0.010±0.006)	0.5±0.1 (0.020±0.004)
BK3216	4W, 4S, 4M, (1206)	3.2±0.2 (0.126±0.008)	1.6±0.2 (0.063±0.008)	0.8±0.1 (0.031±0.004)	0.35±0.2 (0.014±0.008)	0.3±0.2 (0.012±0.008)	0.8±0.1 (0.031±0.004)

Unit : mm (inch)

概略バリエーション AVAILABLE MATERIALS

BK2010

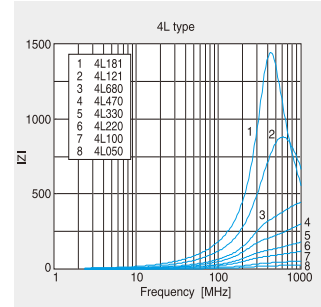
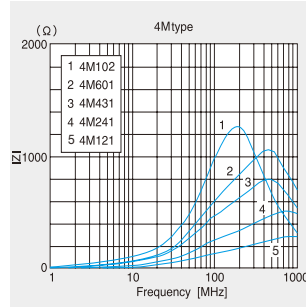
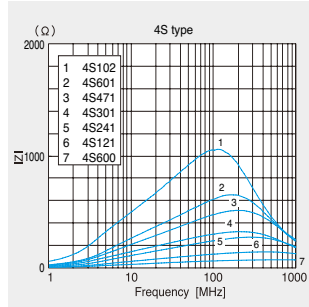
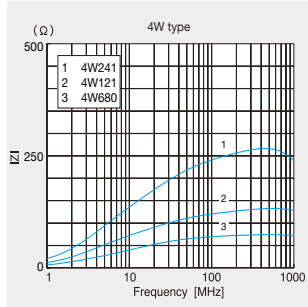

BK3216

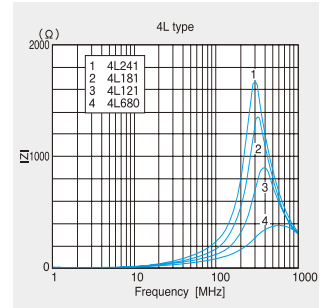
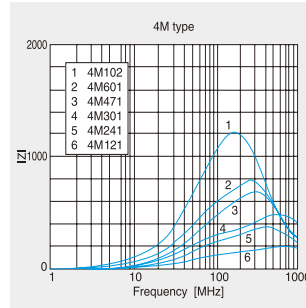
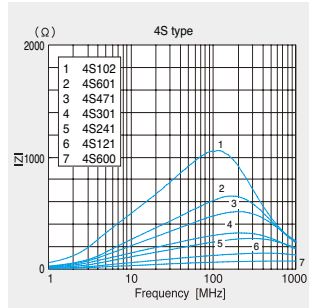
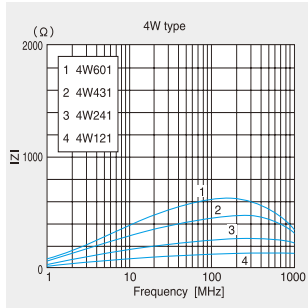

セクションガイド
Selection Guide



etc

アイテム一覧
Part Numbers



特性図
Electrical Characteristics



梱包
Packaging



信頼性
Reliability Data



使用上の注意
Precautions



BK2010

形名 Ordering code	EHS (Environmental Hazardous Substances)	インピーダンス Impedance [Ω]±25%	測定周波数 Measuring Frequency [MHz]	直流抵抗 DC Resistance [Ω] (max.)	定格電流 Rated current [mA] (max.)
BK2010 4W680	RoHS	68	100	0.35	100
BK2010 4W121	RoHS	120		0.40	
BK2010 4W241	RoHS	240		0.50	
BK2010 4S121	RoHS	120		0.30	
BK2010 4S241	RoHS	240		0.45	
BK2010 4S431	RoHS	430		0.55	
BK2010 4S601	RoHS	600		0.70	
BK2010 4M121	RoHS	120		0.30	
BK2010 4M241	RoHS	240		0.45	
BK2010 4M431	RoHS	430		0.55	
BK2010 4M601	RoHS	600		0.70	
BK2010 4M102	RoHS	1000		0.80	
BK2010 4L050	RoHS	5		0.10	
BK2010 4L100	RoHS	10		0.15	
BK2010 4L220	RoHS	22		0.20	
BK2010 4L330	RoHS	33		0.30	
BK2010 4L470	RoHS	47		0.40	
BK2010 4L680	RoHS	68		0.50	
BK2010 4L121	RoHS	120		0.70	
BK2010 4L181	RoHS	180		0.90	

BK3216

形名 Ordering code	EHS (Environmental Hazardous Substances)	インピーダンス Impedance [Ω]±25%	測定周波数 Measuring Frequency [MHz]	直流抵抗 DC Resistance [Ω] (max.)	定格電流 Rated current [mA] (max.)
BK3216 4W121	RoHS	120	100	0.15	100
BK3216 4W241	RoHS	240		0.25	100
BK3216 4W431	RoHS	430		0.35	100
BK3216 4W601	RoHS	600		0.40	100
BK3216 4S600	RoHS	60		0.18	200
BK3216 4S121	RoHS	120		0.18	200
BK3216 4S241	RoHS	240		0.30	200
BK3216 4S301	RoHS	300		0.40	200
BK3216 4S471	RoHS	470		0.40	200
BK3216 4S601	RoHS	600		0.45	200
BK3216 4S102	RoHS	1000		0.68	100
BK3216 4M121	RoHS	120		0.20	150
BK3216 4M241	RoHS	240		0.35	150
BK3216 4M301	RoHS	300		0.45	150
BK3216 4M471	RoHS	470		0.50	150
BK3216 4M601	RoHS	600		0.60	100
BK3216 4M102	RoHS	1000		0.80	100
BK3216 4L680	RoHS	68		0.35	200
BK3216 4L121	RoHS	120		0.55	200
BK3216 4L181	RoHS	180		0.65	150
BK3216 4L241	RoHS	240	0.75	150	

BK2010

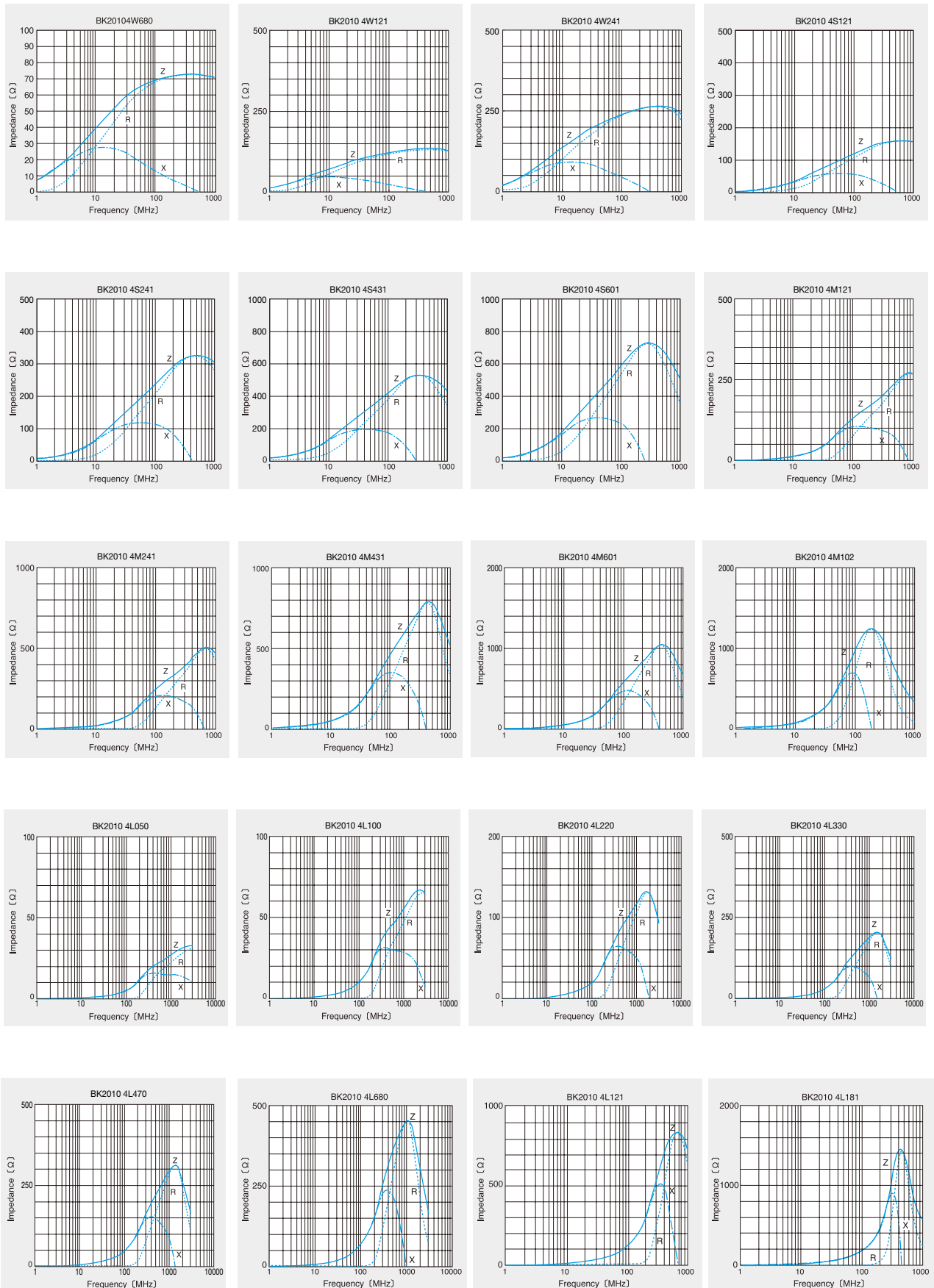

BK3216

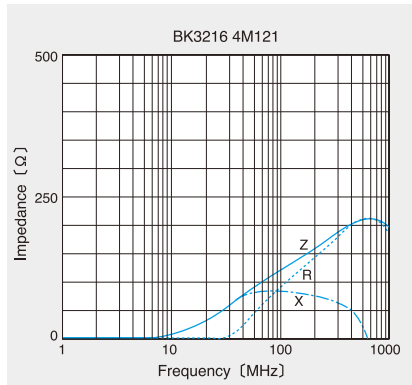
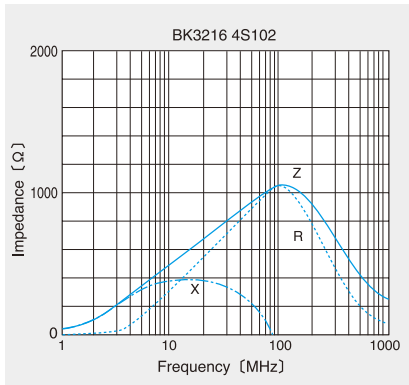
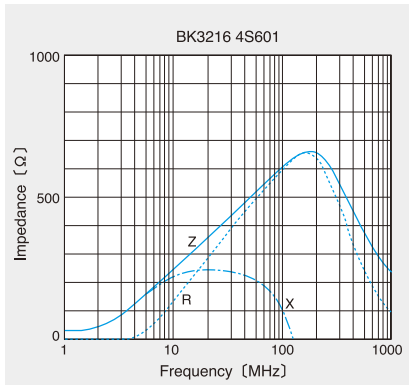
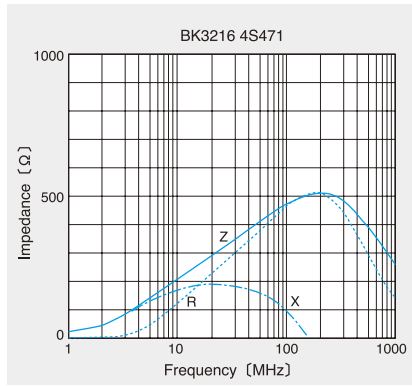
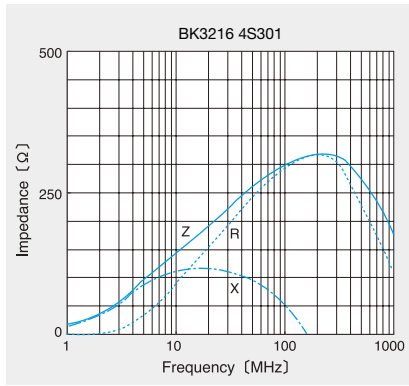
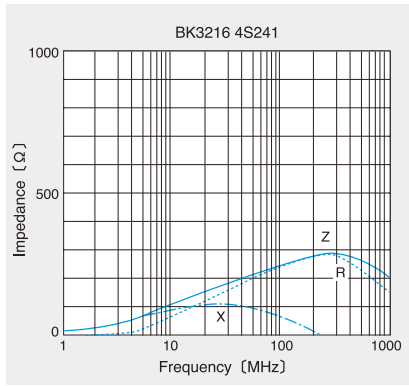
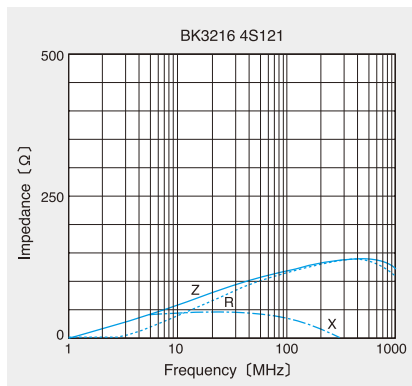
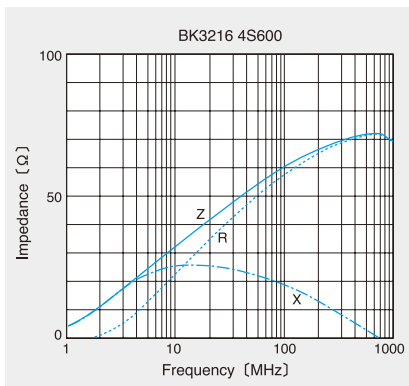
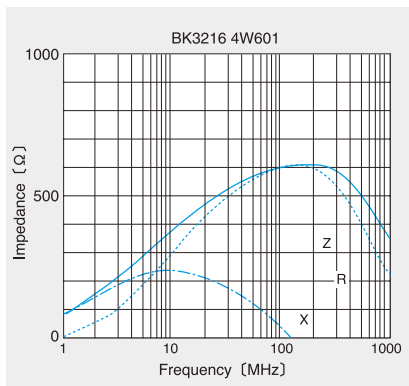
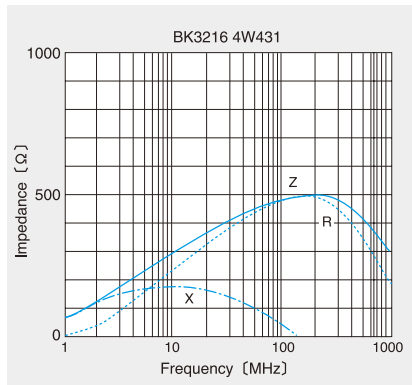
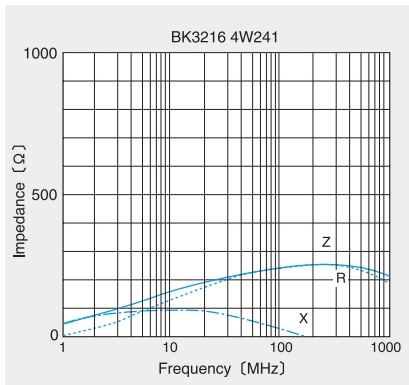
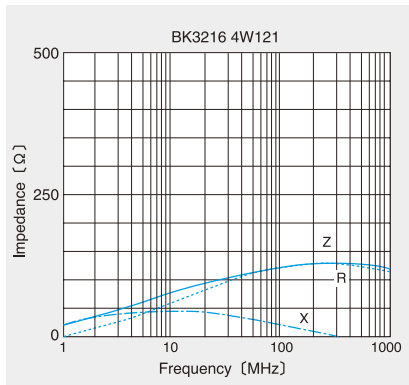

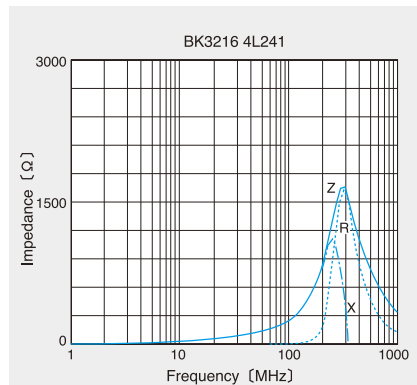
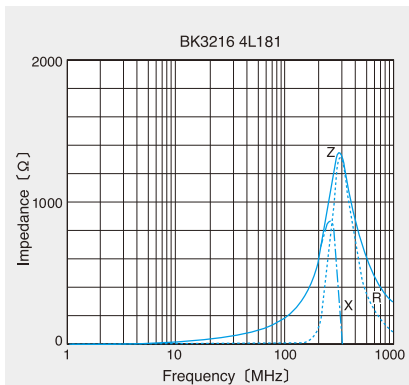
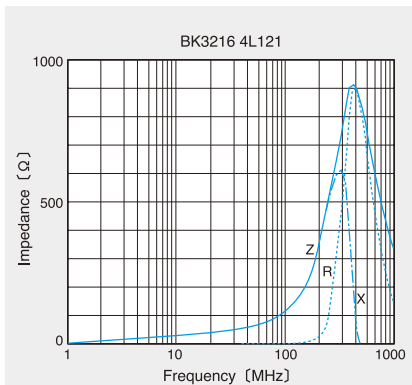
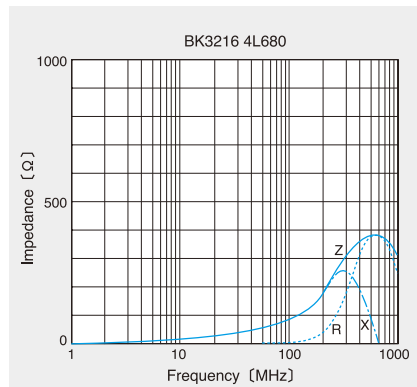
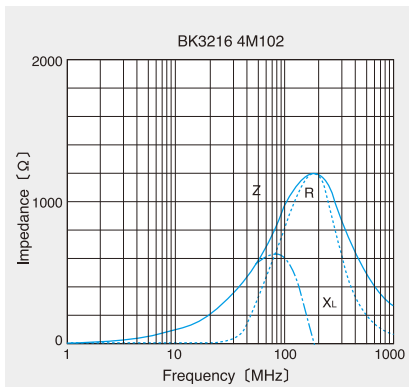
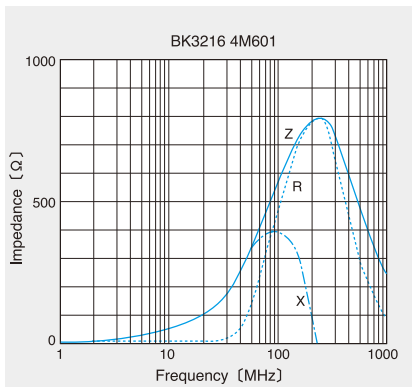
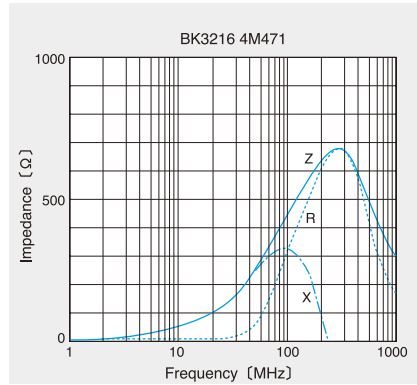
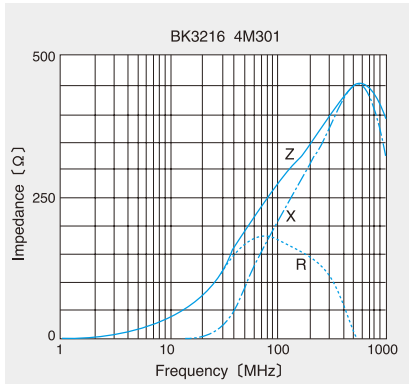
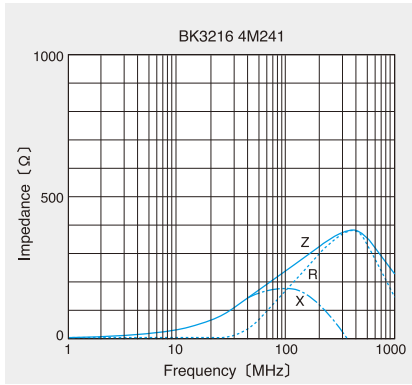

①最小受注単位数 Minimum Quantity
 ■テーピング梱包 Tape & Reel Packaging

形式 Type	製品厚み Thickness [mm] (inch)	標準数量 [pcs] Standard Quantity	
		紙テープ Paper Tape	エンボステープ Embossed Tape
CK1608(0603)	0.8 (0.031)	4000	—
CK2125(0805)	0.85 (0.033)	4000	—
	1.25 (0.049)	—	2000
CKP2520(1008)	0.85 (0.033)	—	3000
LK1005(0402)	0.5 (0.020)	10000	—
LK1608(0603)	0.8 (0.031)	4000	—
LK2125(0805)	0.85 (0.033)	4000	—
	1.25 (0.049)	—	2000
HK0603(0201)	0.3 (0.012)	15000	—
HK1005(0402)	0.5 (0.020)	10000	—
HK1608(0603)	0.8 (0.031)	4000	—
HK2125(0805)	0.85 (0.033)	—	4000
	1.0 (0.039)	—	3000
HKQ0603(0201)	0.3 (0.012)	15000	—
AQ105(0402)	0.5 (0.020)	10000	—
BK0603(0201)	0.3 (0.012)	15000	—
BK1005(0402)	0.5 (0.020)	10000	—
BK1608(0603)	0.8 (0.031)	4000	—
BK2125(0805)	0.85 (0.033)	4000	—
	1.25 (0.049)	—	2000
BK2010(0804)	0.45 (0.018)	4000	—
BK3216(1206)	0.8 (0.031)	—	4000
BKP1005(0402)	0.5 (0.020)	10000	—
BKP1608(0603)	0.8 (0.031)	4000	—
BKP2125(0805)	0.85 (0.033)	4000	—

②テーピング材質 Taping material

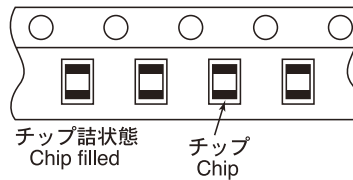
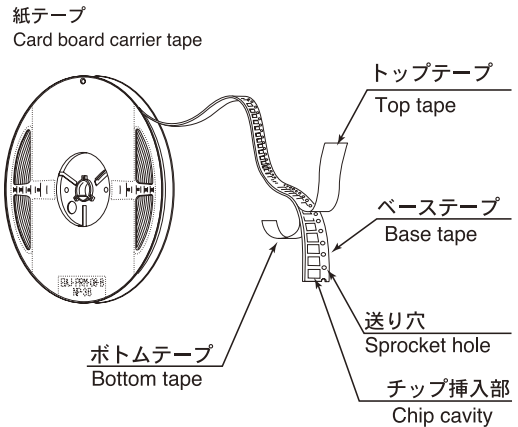

CK	1608
CK	2125
LK	1005
LK	1608
LK	2125
HK	0603
HK	1005
HK	1608
HKQ	0603
AQ	105
BK	0603
BK	1005
BK	1608
BK	2125
BK	2010
BKP	1005
BKP	1608
BKP	2125

エンボステープ
Embossed Tape

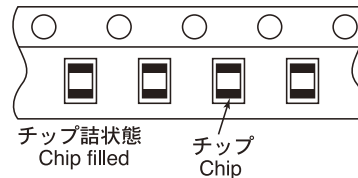
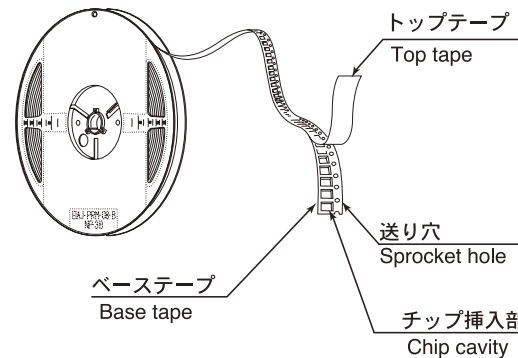

CK	2125
CKP	2520
LK	2125
HK	2125
BK	2125
BK	3216

③テーピング寸法 Taping Dimensions

・紙テープ (8mm幅) Paper tape (0.315 inches wide)

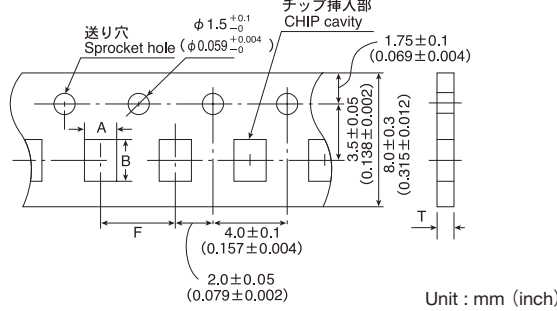

形式 Type	製品厚み Thickness [mm]	チップ挿入部 Chip cavity		挿入ピッチ Insertion Pitch F	テープ厚み Tape Thickness T
		A	B		
CK1608 (0603)	0.8 (0.031)	1.0±0.2 (0.039±0.008)	1.8±0.2 (0.071±0.008)	4.0±0.1 (0.157±0.004)	1.1max (0.043max)
CK2125 (0805)	0.85 (0.033)	1.5±0.2 (0.059±0.008)	2.3±0.2 (0.091±0.008)	4.0±0.1 (0.157±0.004)	1.1max (0.043max)
LK1005 (0402)	0.5 (0.020)	0.65±0.1 (0.026±0.004)	1.15±0.1 (0.045±0.004)	2.0±0.05 (0.079±0.002)	0.8max (0.031max)
LK1608 (0603)	0.8 (0.031)	1.0±0.2 (0.039±0.008)	1.8±0.2 (0.071±0.008)	4.0±0.1 (0.157±0.004)	1.1max (0.043max)
LK2125 (0805)	0.85 (0.033)	1.5±0.2 (0.059±0.008)	2.3±0.2 (0.091±0.008)	4.0±0.1 (0.157±0.004)	1.1max (0.043max)
HK0603 (0201)	0.3 (0.012)	0.40±0.06 (0.016±0.002)	0.70±0.06 (0.028±0.002)	2.0±0.05 (0.079±0.002)	0.45max (0.018max)
HK1005 (0402)	0.5 (0.020)	0.65±0.1 (0.026±0.004)	1.15±0.1 (0.045±0.004)	2.0±0.05 (0.079±0.002)	0.8max (0.031max)
HK1608 (0603)	0.8 (0.031)	1.0±0.2 (0.039±0.008)	1.8±0.2 (0.071±0.008)	4.0±0.1 (0.157±0.004)	1.1max (0.043max)
HKQ0603 (0201)	0.3 (0.012)	0.40±0.06 (0.016±0.002)	0.70±0.06 (0.028±0.002)	2.0±0.05 (0.079±0.002)	0.45max (0.018max)
AQ105 (0402)	0.5 (0.020)	0.75±0.1 (0.030±0.004)	1.15±0.1 (0.045±0.004)	2.0±0.05 (0.079±0.002)	0.8max (0.031max)
BK0603 (0201)	0.3 (0.012)	0.40±0.06 (0.016±0.002)	0.70±0.06 (0.028±0.002)	2.0±0.05 (0.079±0.002)	0.45max (0.018max)
BK1005 (0402)	0.5 (0.020)	0.65±0.1 (0.026±0.004)	1.15±0.1 (0.045±0.004)	2.0±0.05 (0.079±0.002)	0.8max (0.031max)
BK1608 (0603)	0.8 (0.031)	1.0±0.2 (0.039±0.008)	1.8±0.2 (0.071±0.008)	4.0±0.1 (0.157±0.004)	1.1max (0.043max)
BK2125 (0805)	0.85 (0.033)	1.5±0.2 (0.059±0.008)	2.3±0.2 (0.091±0.008)	4.0±0.1 (0.157±0.004)	1.1max (0.043max)
BK2010 (0804)	0.45 (0.018)	1.2±0.1 (0.047±0.004)	2.17±0.1 (0.085±0.004)	4.0±0.1 (0.157±0.004)	0.80max (0.031max)
BKP1005 (0402)	0.5 (0.020)	0.65±0.1 (0.026±0.004)	1.15±0.1 (0.045±0.004)	2.0±0.05 (0.079±0.002)	0.8max (0.031max)
BKP1608 (0603)	0.8 (0.031)	1.0±0.2 (0.039±0.008)	1.8±0.2 (0.071±0.008)	4.0±0.1 (0.157±0.004)	1.1max (0.043max)
BKP2125 (0805)	0.85 (0.033)	1.5±0.2 (0.059±0.008)	2.3±0.2 (0.091±0.008)	4.0±0.1 (0.157±0.004)	1.1max (0.043max)

・エンボステープ (8mm幅) Embossed Tape (0.312 inches wide)

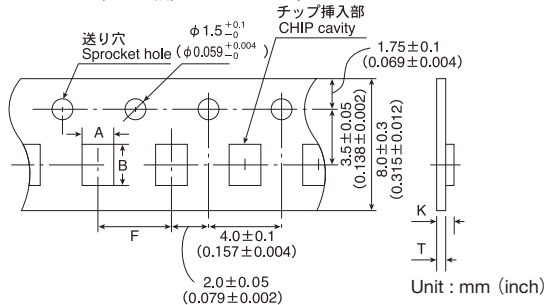

形式 Type	製品厚み Thickness [mm]	チップ挿入部 Chip cavity		挿入ピッチ Insertion Pitch F	テープ厚みmax. Tape Thickness K T	
		A	B		K	T
CK2125 (0805)	1.25 (0.049)	1.5±0.2 (0.059±0.008)	2.3±0.2 (0.091±0.008)	4.0±0.1 (0.157±0.004)	2.0 (0.079)	0.3 (0.012)
CKP2520 (1008)	0.85 (0.033)	2.15±0.1 (0.085±0.004)	2.7±0.1 (0.107±0.004)	4.0±0.1 (0.157±0.004)	1.5 (0.059)	0.3 (0.012)
LK2125 (0805)	1.25 (0.049)	1.5±0.2 (0.059±0.008)	2.3±0.2 (0.091±0.008)	4.0±0.1 (0.157±0.004)	2.0 (0.079)	0.3 (0.012)
HK2125 (0805)	0.85 (0.033)	1.5±0.2 (0.059±0.008)	2.3±0.2 (0.091±0.008)	4.0±0.1 (0.157±0.004)	1.5 (0.059)	0.3 (0.012)
	1.0 (0.039)				2.0 (0.079)	
BK2125 (0805)	1.25 (0.049)	1.5±0.2 (0.059±0.008)	2.3±0.2 (0.091±0.008)	4.0±0.1 (0.157±0.004)	2.0 (0.079)	0.3 (0.012)
BK3216 (1206)	0.8 (0.031)	1.9±0.1 (0.075±0.004)	3.5±0.1 (0.138±0.004)	4.0±0.1 (0.157±0.004)	1.4 (0.055)	0.3 (0.012)

④リーダー部・空部 LEADER AND BLANK PORTION

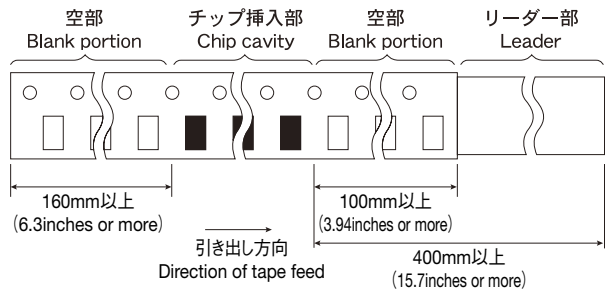

⑤リール寸法 Reel Size

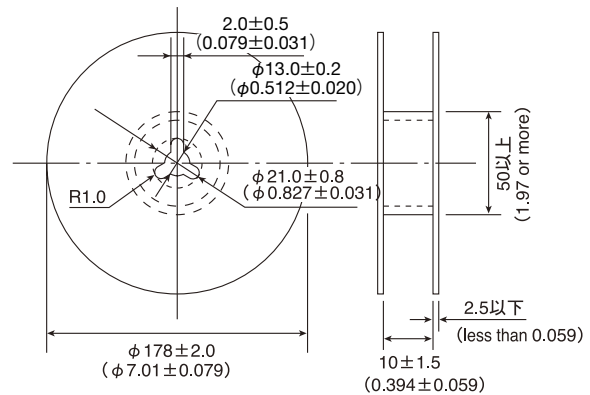

⑥トップテープ強度 Top tape strength

トップテープの剥離力は、下図矢印方向にて0.1~0.7Nとなります。
 The top tape requires a peel-off force of 0.1~0.7N in the direction of the arrow as illustrated below.

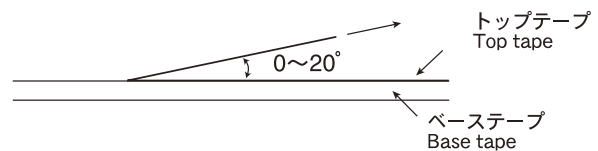

Multilayer chip inductors and beads

Item	Specified Value																				Test Methods and Remarks				
	BK0603	BK1005	BK1608	BK2125	ARRAY		BKP1005	BKP1608	BKP2125	CK1608	CK2125	CKP2520	LK1005	LK1608	LK2125	HK0603	HK1005	HK1608	HK2125	HKQ0603		AQ105			
					BK2010	BK3216																			
1. Operating Temperature Range	-55~+125°C				-55~+85°C				-40~+85°C				-55~+125°C				-40~+85°C				-55~+125°C		-55~+125°C		
2. Storage Temperature Range	-55~+125°C				-55~+85°C				-40~+85°C				-55~+125°C				-40~+85°C				-55~+125°C		-55~+125°C		
3. Rated Current	100~500mA DC	150~1000mA DC	150~1500mA DC	200~1200mA DC	100mA DC	100~200mA DC	1.0A DC	1.0~3.0A DC	2.0~4.0A DC	50~60mA DC	60~500mA DC	1.1~1.4A DC	10~25mA DC	1~50mA DC	5~300mA DC	40~250mA DC	110~300mA DC	150~300mA DC	300mA DC	100~400mA DC	200~510mA DC				
4. Impedance	10~600Ω ±25%	10~1000Ω ±25%	22~2500Ω ±25%	15~2500Ω ±25%	5~600Ω ±25%	68~1000Ω ±25%	120Ω ±25%	33~390Ω ±25%	33~220Ω ±25%																BK0603 Series: Measuring frequency: 100±1MHz Measuring equipment: HP4291A Measuring jig: 16193A BK1005 Series: BKP1005 Series: Measuring frequency: 100±1MHz Measuring equipment: HP4291A Measuring jig: 16192A, 16193A BK1608, 2125 Series: BKP1608, 2125 Series: Measuring frequency: 100±1MHz Measuring equipment: HP4291A, HP4195A Measuring jig: 16092A or 16192A (HW) BK2010, 3216 Series: Measuring frequency: 100±1MHz Measuring equipment: HP4291A, HP4195A Measuring jig: 16192A
5. Inductance										4.7~10.0μH ±20%	0.1~10.0μH ±20%	1.0~4.7μH ±20%	0.12~2.2μH ±10%	0.047~33.0μH ±20%	0.047~33.0μH ±20%	1.0~6.2nH ±5%	1.0~6.2nH ±5%	1.0~5.6nH ±5%	1.0~5.6nH ±5%	0.6~6.2nH ±5%	0.6~6.2nH ±5%	1.0~6.2nH ±5%	CK Series: Measuring frequency: 2 to 4MHz (CK1608) Measuring frequency: 2 to 25MHz (CK2125) Measuring frequency: 1MHz (CKP2520) LK Series: Measuring frequency: 10 to 25MHz (LK1005) Measuring frequency: 1 to 50MHz (LK1608) Measuring frequency: 0.4 to 50MHz (LK2125) Measuring equipment, jig: HP4194+16085B+16092A (or its equivalent) HP4195+41951+16092A (or its equivalent) HP4294+16192A HP4291A+16193A (LK1005) HP4285A+42841A+42842C+ 42851-61100 (CKP2520) Measuring current: 1mA rms (0.047 to 4.7μH) 0.1mA rms (5.6 to 33μH) HK·HKQ·AQ Series: Measuring frequency: 100MHz (HK0603, HK1005, AQ105) Measuring frequency: 50/100MHz (HK1608, HK2125) Measuring frequency: 500MHz (HKQ0603) Measuring equipment, jig: HP4291A+16197A (HK0603-AQ105) HP4291A+16193A (HK1005) E4991A+16197A (HKQ0603) HP4291A (or its equivalent)+16092A+in-house made jig (HK1608, 2125)		

* Definition of rated current : In the CK and BK Series, the rated current is the value of current at which the temperature of the element is increased within 20°C .

In the BK Series P type and CK Series P type, the rated current is the value of current at which the temperature of the element is increased within 40°C .

In the LK, HK, HKQ, and AQ Series, the rated current is either the DC value at which the internal L value is decreased within 5% with the application of DC bias, or the value of current at which the temperature of the element is increased within 20°C .

Multilayer chip inductors and beads

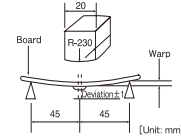
Item	Specified Value																			Test Methods and Remarks			
	BK0603	BK1005	BK1608	BK2125	ARRAY		BKP1005	BKP1608	BKP2125	CK1608	CK2125	CXP2520	LK1005	LK1608	LK2125	HK0603	HK1005	HK1608	HK2125		HKQ0603	AQ105	
					BK2010	BK3216																	
6.Q																							CK Series: Measuring frequency: 2 to 4 MHz (CK1608) Measuring frequency: 2 to 25 MHz (CK2125) LK Series: Measuring frequency: 10 to 25 MHz (LK1005) Measuring frequency: 1 to 50 MHz (LK1608) Measuring frequency: 0.4 to 50MHz (LK2125) Measuring equipment, jig: HP4194A + 1608SB + 16092A (or its equivalent) HP4195A + 41951 + 16092A (or its equivalent) HP4294A + 16192A HP4291A + 16193A (LK1005) Measuring current: 1mA rms (0.047 to 4.7μH) 0.1mA rms (5.6 to 33μH) HK, HKQ, AQ Series: Measuring frequency: 100MHz (HK0603, HK1005, AQ105) Measuring frequency: 50 / 100MHz (HK1608, 2125) Measuring frequency: 500MHz (HKQ0603) Measuring frequency: HP4291A + 16197A (HK0603, AQ105) HP4291A + 16193A (HK1005) E4991A + 16197A (HKQ0603) HP4195A + 16092A + in-house made jig (HK1608, 2125)
7.DC Resistance	0.075~ 1.50Ω max.	0.05~ 0.80Ω max.	0.05~ 1.10Ω max.	0.05~ 0.75Ω max.	0.10~ 0.90Ω max.	0.15~ 0.80Ω max.	0.140Ω max.	0.025~ 0.140Ω max.	0.020~ 0.050Ω max.	0.45~ 0.85Ω (±30%) max.	0.16~ 0.65Ω max.	0.08~ 0.15Ω max.	0.7~ 1.70Ω max.	0.3~ 2.95Ω max.	0.20~ 1.25Ω max.	0.14~ 4.0Ω max.	0.08~ 4.8Ω max.	0.05~ 2.6Ω max.	0.10~ 1.5Ω max.	0.10~ 1.28Ω max.	0.07~ 0.45Ω max.	Measuring equipment: VOAC-7412 (made by Iwasaki Tsushinki) VOAC-7512 (made by Iwasaki Tsushinki)	
8.Self Resonance Frequency (SRF)										17~ 25MHz min.	24~ 235MHz min.		40~ 180MHz min.	9~ 260MHz min.	13~ 320MHz min.	900~ 10000MHz min.	400~ 10000MHz min.	300~ 10000MHz min.	200~ 4000MHz min.	2000~ 10000MHz min.	2300~ 10000MHz min.	LK Series: Measuring equipment: HP4195A Measuring jig: 41951 + 16092A (or its equivalent) HK, HKQ, AQ Series: Measuring equipment: HP8719C · HP8753D (HK2125)	
9.Temperature Characteristic																							Inductance change: Within ±10% HK, HKQ, AQ Series: Temperature range: -30 to +85°C Reference temperature: +20°C
10. Resistance to Flexure of Substrate	No mechanical damage.																				Warp: 2mm Testing board: glass epoxy-resin substrate Thickness: 0.8mm 		

Multilayer chip inductors and beads

Item	Specified Value																Test Methods and Remarks			
	BK0603	BK1005	BK1608	BK2125	ARRAY		BK1005	BK1608	BK2125	CK1608	CK2125	CKP2520	LK1005	LK1608	LK2125	HK0603		HK1005	HK1608	HK2125
11.Solderability	At least 75% of terminal electrode is covered by new solder.						At least 75% of terminal electrode is covered by new solder.						Solder temperature: 230±5°C Duration: 4±1 sec.							
12.Resistance to Soldering	Appearance: No significant abnormality Impedance change: Within ±30%						No mechanical damage. Remaining terminal electrode: 70% min. Inductance change R10~4R7: Within±10% 6R8~100: Within±15% CKP2520: Within±30%		No mechanical damage. Remaining terminal electrode: 70% min. Inductance change: Within ±15%	No mechanical damage. Remaining terminal electrode: 70% min. Inductance change 47N~4R7: Within±10% 5R6~330: Within±15%		No mechanical damage. Remaining terminal electrode: 70% min. Inductance change: Within±5%				Solder temperature: 260±5°C Duration: 10±0.5 sec. Preheating temperature: 150 to 180°C Preheating time: 3 min. Flux: Immersion into methanol solution with colophony for 3 to 5 sec. Recovery: 2 to 3 hrs of recovery under the standard condition after the test. (See Note 1)				
13.Thermal Shock	Appearance: No significant abnormality Impedance change: Within ±30%						No mechanical damage. Inductance change: Within ±20% Qchange: Within ±30%		No mechanical damage. Inductance change: Within ±30%	No mechanical damage. Inductance change: Within±10% Qchange: Within±30%		No mechanical damage. Inductance change: Within±10% Qchange: Within±20%				Conditions for 1 cycle step 1: Minimum operating temperature +0/-3°C 30±3 min. step 2: Room temperature 2 to 3min. step 3: Minimum operating temperature +0/-3°C 30±3 min. step 4: Room temperature 2 to 3min. Number of cycles: 5 Recovery: 2 to 3 hrs of recovery under the standard condition after the test. (See Note 1)				

(Note 1) When there are questions concerning measurement result : measurement shall be made after 48 ± 2 hrs of recovery under the standard condition.

Multilayer chip inductors and beads

Item	Specified Value														Test Methods and Remarks							
	BK0603	BK1005	BK1608	BK2125	ARRAY		BKP1005	BKP1608	BKP2125	CK1608	CK2125	CKP2520	LK1005	LK1608		LK2125	HK0603	HK1005	HK1608	HK2125	HKQ0603	AQ105
14. Damp Heat fSteady statag	Appearance: No significant abnormality Impedance change: Within $\pm 30\%$						No mechanical damage. Inductance change: Within $\pm 20\%$ Q change: Within $\pm 30\%$	No mechanical damage. Inductance change: Within $\pm 30\%$	No mechanical damage. Inductance change: Within $\pm 10\%$ Q change: Within $\pm 30\%$	No mechanical damage. Inductance change: Within $\pm 10\%$ Q change: Within $\pm 10\%$	No mechanical damage. Inductance change: Within $\pm 10\%$ Q change: Within $\pm 30\%$	No mechanical damage. Inductance change: Within $\pm 10\%$	No mechanical damage. Inductance change: Within $\pm 10\%$ Q change: Within $\pm 20\%$									BK Series: Temperature: $40 \pm 2^\circ\text{C}$ Humidity: 90 to 95%RH Duration: 500 ± 5^4 hrs Recovery: 2 to 3 hrs of recovery under the standard condition after the removal from test chamber. (See Note1) LK, CK, CKP, HK, HKQ, AQ Series: Temperature: $40 \pm 2^\circ\text{C}$ (LK, CK Series) $60 \pm 2^\circ\text{C}$ (HK, HKQ, AQ Series) Humidity: 90 to 95%RH Duration: 500 ± 12 hours Recovery: 2 to 3 hrs of recovery under the standard condition after the removal from test chamber. (See Note1)
15. Loading under Damp Heat	No mechanical damage, Inductance change within $\pm 30\%$						No mechanical damage. Inductance change: Within $\pm 20\%$ Q change: Within $\pm 30\%$	No mechanical damage. Inductance change: Within $\pm 30\%$	No mechanical damage. Inductance change: Within $\pm 10\%$ Q change: Within $\pm 10\%$	No mechanical damage. Inductance change: 0.047 to $12.0\mu\text{H}$ Within $\pm 10\%$ Q change: $\pm 10\%$ to 15.0 to $33.0\mu\text{H}$ Within $\pm 15\%$ Q change: Within $\pm 30\%$	No mechanical damage. Inductance change: Within $\pm 10\%$ Q change: Within $\pm 30\%$	No mechanical damage. Inductance change: Within $\pm 10\%$ Q change: Within $\pm 30\%$	No mechanical damage. Inductance change: Within $\pm 10\%$ Q change: Within $\pm 20\%$									BK Series: Temperature: $40 \pm 2^\circ\text{C}$ (LK Series) Humidity: 90 to 95%RH Duration: 500 ± 5^4 hrs Applied current: Rated current Recovery: 2 to 3 hrs of recovery under the standard condition after the removal from test chamber. (See Note1) LK, CK, CKP, HK, HKQ, AQ Series: Temperature: $40 \pm 2^\circ\text{C}$ (LK, CK Series) $60 \pm 2^\circ\text{C}$ (HK, HKQ, AQ Series) Humidity: 90 to 95%RH Duration: 500 ± 12 hrs Applied current: Rated current Recovery: 2 to 3 hrs of recovery under the standard condition after the removal from test chamber. (See Note1)
16. Loading at High Temperature	Appearance: No significant abnormality Impedance change: Within $\pm 30\%$						No mechanical damage. Inductance change: Within $\pm 20\%$ Q change: Within $\pm 30\%$	No mechanical damage. Inductance change: Within $\pm 30\%$	No mechanical damage. Inductance change: Within $\pm 10\%$ Q change: Within $\pm 10\%$	No mechanical damage. Inductance change: 0.047 to $12.0\mu\text{H}$ Within $\pm 10\%$ Q change: $\pm 10\%$ to 15.0 to $33.0\mu\text{H}$ Within $\pm 15\%$ Q change: Within $\pm 30\%$	No mechanical damage. Inductance change: Within $\pm 10\%$ Q change: Within $\pm 30\%$	No mechanical damage. Inductance change: Within $\pm 10\%$ Q change: Within $\pm 30\%$	No mechanical damage. Inductance change: Within $\pm 10\%$ Q change: Within $\pm 20\%$									BK Series: Temperature: $125 \pm 3^\circ\text{C}$ Applied current: Rated current Duration: 500 ± 5^4 hrs Recovery: 2 to 3 hrs of recovery under the standard condition after the removal from test chamber. (See Note1) LK, CK, CKP, HK, HKQ, AQ Series, BK Series P type: Temperature: $85 \pm 2^\circ\text{C}$ (LK, CK, CKP Series) $85 \pm 3^\circ\text{C}$ (BK Series P type) $85 \pm 2^\circ\text{C}$ (HK 1608, 2125) $85 \pm 2^\circ\text{C}$ (HK 1005 AQ105 operating temperature range -55 to $+85^\circ\text{C}$) $125 \pm 2^\circ\text{C}$ (HK 0603, HK1005, HKQ0603, AQ105) operating temperature range -55 to $+125^\circ\text{C}$) Applied current: Rated current Duration: 500 ± 12 hrs Recovery: 2 to 3 hrs of recovery under the standard condition after the removal from test chamber. (See Note1)

Note on standard condition: "standard condition" referred to herein is defined as follows:
5 to 35°C of temperature, 45 to 85% relative humidity, and 86 to 106kPa of air pressure.

When there are questions concerning measurement results:

In order to provide correlation data, the test shall be conducted under condition of $20 \pm 2^\circ\text{C}$ of temperature, 60 to 70% relative humidity, and 86 to 106kPa of air pressure. Unless otherwise specified, all the tests are conducted under the "standard condition."





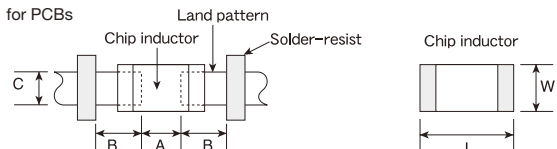
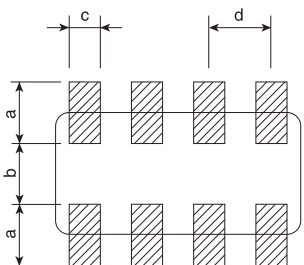

(Note 1)

measurement shall be made after 48 ± 2 hrs of recovery under the standard condition.

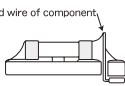
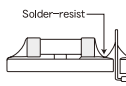
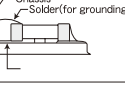
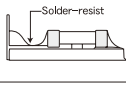
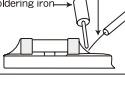
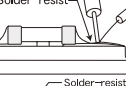
Precautions on the use of Multilayer chip Inductors, Multilayer chip inductors for high frequency, Multilayer ferrite chip beads

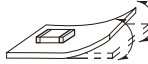
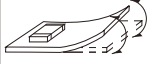
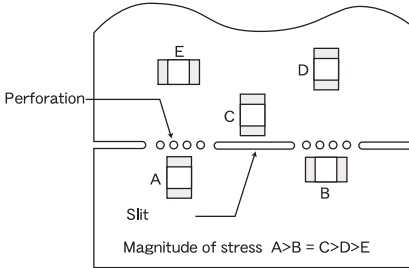
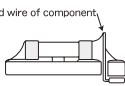
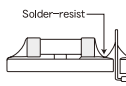
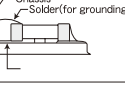
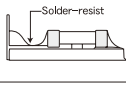
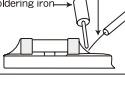
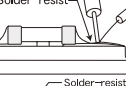
Stages	Precautions	Technical considerations																																																																																																						
1. Circuit Design	<p>◆Verification of operating environment, electrical rating and performance</p> <p>1. A malfunction in medical equipment, spacecraft, nuclear reactors, etc. may cause serious harm to human life or have severe social ramifications. As such, any inductors to be used in such equipment may require higher safety and/or reliability considerations and should be clearly differentiated from components used in general purpose applications.</p> <p>◆Operating Current (Verification of Rated current)</p> <p>1. The operating current for inductors must always be lower than their rated values.</p> <p>2. Do not apply current in excess of the rated value because the inductance may be reduced due to the magnetic saturation effect.</p>																																																																																																							
2. PCB Design	<p>◆Pattern configurations (Design of Land-patterns)</p> <p>1. When inductors are mounted on a PCB, the size of land patterns and the amount of solder used (size of fillet) can directly affect inductor performance. Therefore, the following items must be carefully considered in the design of solder land patterns:</p> <p>(1) The amount of solder applied can affect the ability of chips to withstand mechanical stresses which may lead to breaking or cracking. Therefore, when designing land-patterns it is necessary to consider the appropriate size and configuration of the solder pads which in turn determines the amount of solder necessary to form the fillets.</p> <p>(2) When more than one part is jointly soldered onto the same land or pad, the pad must be designed so that each component's soldering point is separated by solder-resist.</p> <p>(3) The larger size of land patterns and amount of solder, the smaller Q value after mounting on PCB. It makes higher the Q value to design land patterns smaller than terminal electrode of chips.</p>	<p>1. The following diagrams and tables show some examples of recommended patterns to prevent excessive solder amounts (larger fillets which extend above the component end terminations). Examples of improper pattern designs are also shown.</p> <p>(1) Recommended land dimensions for a typical chip inductor land patterns for PCBs</p>  <p>Recommended land dimensions for wave-soldering (unit: mm)</p> <table border="1" data-bbox="860 1113 1258 1291"> <thead> <tr> <th>Type</th> <th>1608</th> <th>2125</th> <th>3216</th> </tr> </thead> <tbody> <tr> <td rowspan="2">SIZE</td> <td>L</td> <td>1.6</td> <td>2.0</td> <td>3.2</td> </tr> <tr> <td>W</td> <td>0.8</td> <td>1.25</td> <td>1.6</td> </tr> <tr> <td>A</td> <td>0.8~1.0</td> <td>1.0~1.4</td> <td>1.8~2.5</td> </tr> <tr> <td>B</td> <td>0.5~0.8</td> <td>0.8~1.5</td> <td>0.8~1.7</td> </tr> <tr> <td>C</td> <td>0.6~0.8</td> <td>0.9~1.2</td> <td>1.2~1.6</td> </tr> </tbody> </table> <p>Recommended land dimensions for reflow-soldering (unit: mm)</p> <table border="1" data-bbox="860 1344 1450 1522"> <thead> <tr> <th>Type</th> <th>0603</th> <th>1005</th> <th>105</th> <th>1608</th> <th>2125</th> <th>3216</th> <th>2520</th> </tr> </thead> <tbody> <tr> <td rowspan="2">SIZE</td> <td>L</td> <td>0.6</td> <td>1.0</td> <td>1.6</td> <td>2.0</td> <td>3.2</td> <td>2.5</td> </tr> <tr> <td>W</td> <td>0.3</td> <td>0.5</td> <td>0.6</td> <td>0.8</td> <td>1.25</td> <td>1.6</td> <td>2.0</td> </tr> <tr> <td>A</td> <td>0.20~0.30</td> <td>0.45~0.55</td> <td>0.50~0.55</td> <td>0.6~0.8</td> <td>0.8~1.2</td> <td>1.8~2.5</td> <td>1.0~1.4</td> </tr> <tr> <td>B</td> <td>0.20~0.30</td> <td>0.40~0.50</td> <td>0.30~0.40</td> <td>0.6~0.8</td> <td>0.8~1.2</td> <td>0.6~1.5</td> <td>0.6~1.0</td> </tr> <tr> <td>C</td> <td>0.25~0.40</td> <td>0.45~0.55</td> <td>0.60~0.70</td> <td>0.6~0.8</td> <td>0.9~1.6</td> <td>1.2~2.0</td> <td>1.8~2.2</td> </tr> </tbody> </table> <p>Excess solder can affect the ability of chips to withstand mechanical stresses. Therefore, please take proper precautions when designing land-patterns.</p>  <p>Recommended land dimension for Reflow-soldering (unit: mm)</p> <table border="1" data-bbox="1185 1690 1450 1900"> <thead> <tr> <th rowspan="2">SIZE</th> <th colspan="2">3216</th> <th colspan="2">2010</th> </tr> <tr> <th>L</th> <th>W</th> <th>L</th> <th>W</th> </tr> </thead> <tbody> <tr> <td>a</td> <td>0.7~0.9</td> <td>0.5~0.6</td> <td></td> <td></td> </tr> <tr> <td>b</td> <td>0.8~1.0</td> <td>0.5~0.6</td> <td></td> <td></td> </tr> <tr> <td>c</td> <td>0.4~0.5</td> <td>0.2~0.3</td> <td></td> <td></td> </tr> <tr> <td>d</td> <td>0.8</td> <td>0.5</td> <td></td> <td></td> </tr> </tbody> </table>	Type	1608	2125	3216	SIZE	L	1.6	2.0	3.2	W	0.8	1.25	1.6	A	0.8~1.0	1.0~1.4	1.8~2.5	B	0.5~0.8	0.8~1.5	0.8~1.7	C	0.6~0.8	0.9~1.2	1.2~1.6	Type	0603	1005	105	1608	2125	3216	2520	SIZE	L	0.6	1.0	1.6	2.0	3.2	2.5	W	0.3	0.5	0.6	0.8	1.25	1.6	2.0	A	0.20~0.30	0.45~0.55	0.50~0.55	0.6~0.8	0.8~1.2	1.8~2.5	1.0~1.4	B	0.20~0.30	0.40~0.50	0.30~0.40	0.6~0.8	0.8~1.2	0.6~1.5	0.6~1.0	C	0.25~0.40	0.45~0.55	0.60~0.70	0.6~0.8	0.9~1.6	1.2~2.0	1.8~2.2	SIZE	3216		2010		L	W	L	W	a	0.7~0.9	0.5~0.6			b	0.8~1.0	0.5~0.6			c	0.4~0.5	0.2~0.3			d	0.8	0.5		
Type	1608	2125	3216																																																																																																					
SIZE	L	1.6	2.0	3.2																																																																																																				
	W	0.8	1.25	1.6																																																																																																				
A	0.8~1.0	1.0~1.4	1.8~2.5																																																																																																					
B	0.5~0.8	0.8~1.5	0.8~1.7																																																																																																					
C	0.6~0.8	0.9~1.2	1.2~1.6																																																																																																					
Type	0603	1005	105	1608	2125	3216	2520																																																																																																	
SIZE	L	0.6	1.0	1.6	2.0	3.2	2.5																																																																																																	
	W	0.3	0.5	0.6	0.8	1.25	1.6	2.0																																																																																																
A	0.20~0.30	0.45~0.55	0.50~0.55	0.6~0.8	0.8~1.2	1.8~2.5	1.0~1.4																																																																																																	
B	0.20~0.30	0.40~0.50	0.30~0.40	0.6~0.8	0.8~1.2	0.6~1.5	0.6~1.0																																																																																																	
C	0.25~0.40	0.45~0.55	0.60~0.70	0.6~0.8	0.9~1.6	1.2~2.0	1.8~2.2																																																																																																	
SIZE	3216		2010																																																																																																					
	L	W	L	W																																																																																																				
a	0.7~0.9	0.5~0.6																																																																																																						
b	0.8~1.0	0.5~0.6																																																																																																						
c	0.4~0.5	0.2~0.3																																																																																																						
d	0.8	0.5																																																																																																						

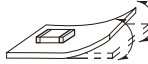
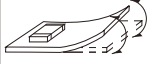
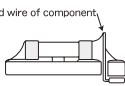
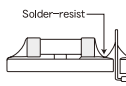
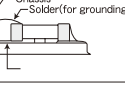
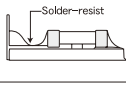
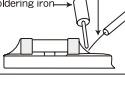
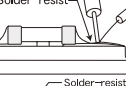
Precautions on the use of Multilayer chip Inductors, Multilayer chip inductors for high frequency, Multilayer ferrite chip beads

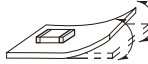
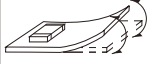
Stages	Precautions	Technical considerations																					
<p>2.PCB Design</p>	<p>◆Pattern configurations (Inductor layout on panelized [breakaway] PC boards)</p> <p>1. After inductors have been mounted on the boards, chips can be subjected to mechanical stresses in subsequent manufacturing processes (PCB cutting, board inspection, mounting of additional parts, assembly into the chassis, wave soldering the reflow soldered boards etc.) For this reason, planning pattern configurations and the position of SMD inductors should be carefully performed to minimize stress.</p>	<p>(2) Examples of good and bad solder application</p> <table border="1" data-bbox="862 285 1442 701"> <thead> <tr> <th></th> <th>Not recommended</th> <th>Recommended</th> </tr> </thead> <tbody> <tr> <td>Mixed mounting of SMD and leaded components</td> <td></td> <td></td> </tr> <tr> <td>Component placement close to the chassis</td> <td></td> <td></td> </tr> <tr> <td>Hand-soldering of leaded components near mounted components</td> <td></td> <td></td> </tr> <tr> <td>Horizontal component placement</td> <td></td> <td></td> </tr> </tbody> </table> <p>1-1. The following are examples of good and bad inductor layout; SMD inductors should be located to minimize any possible mechanical stresses from board warp or deflection.</p> <table border="1" data-bbox="862 814 1442 957"> <thead> <tr> <th>Item</th> <th>Not recommended</th> <th>Recommended</th> </tr> </thead> <tbody> <tr> <td>Deflection of the board</td> <td></td> <td></td> </tr> </tbody> </table> <p>1-2. To layout the inductors for the breakaway PC board, it should be noted that the amount of mechanical stresses given will vary depending on inductor layout. An example below should be counted for better design.</p> <div data-bbox="922 1066 1328 1331" style="border: 1px solid black; padding: 5px;">  <p>Magnitude of stress $A > B = C > D > E$</p> </div> <p>1-3. When breaking PC boards along their perforations, the amount of mechanical stress on the inductors can vary according to the method used. The following methods are listed in order from least stressful to most stressful: push-back, slit, V-grooving, and perforation. Thus, any ideal SMD inductor layout must also consider the PCB splitting procedure.</p>		Not recommended	Recommended	Mixed mounting of SMD and leaded components			Component placement close to the chassis			Hand-soldering of leaded components near mounted components			Horizontal component placement			Item	Not recommended	Recommended	Deflection of the board		
	Not recommended	Recommended																					
Mixed mounting of SMD and leaded components																							
Component placement close to the chassis																							
Hand-soldering of leaded components near mounted components																							
Horizontal component placement																							
Item	Not recommended	Recommended																					
Deflection of the board																							

Precautions on the use of Multilayer chip Inductors, Multilayer chip inductors for high frequency, Multilayer ferrite chip beads

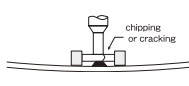
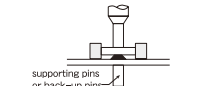
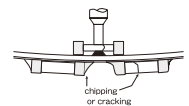
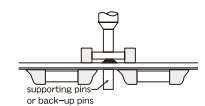
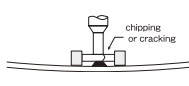
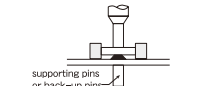
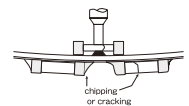
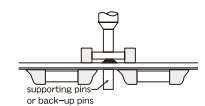
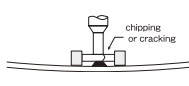
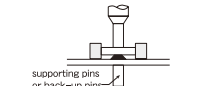
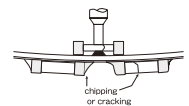
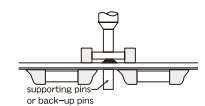
Stages	Precautions	Technical considerations									
<p>3. Considerations for automatic placement</p>	<p>◆ Adjustment of mounting machine</p> <ol style="list-style-type: none"> Excessive impact load should not be imposed on the inductors when mounting onto the PC boards. The maintenance and inspection of the mounter should be conducted periodically. <p>◆ Selection of Adhesives</p> <ol style="list-style-type: none"> Mounting inductors with adhesives in preliminary assembly, before the soldering stage, may lead to degraded inductor characteristics unless the following factors are appropriately checked; the size of land patterns, type of adhesive, amount applied, hardening temperature and hardening period. Therefore, it is imperative to consult the manufacturer of the adhesives on proper usage and amounts of adhesive to use. 	<ol style="list-style-type: none"> If the lower limit of the pick-up nozzle is low, too much force may be imposed on the inductors, causing damage. To avoid this, the following points should be considered before lowering the pick-up nozzle: <ol style="list-style-type: none"> The lower limit of the pick-up nozzle should be adjusted to the surface level of the PC board after correcting for deflection of the board. The pick-up pressure should be adjusted between 1 and 3 N static loads. To reduce the amount of deflection of the board caused by impact of the pick-up nozzle, supporting pins or back-up pins should be used under the PC board. The following diagrams show some typical examples of good pick-up nozzle placement: <table border="1" data-bbox="860 514 1437 777"> <thead> <tr> <th></th> <th>Improper method</th> <th>Proper method</th> </tr> </thead> <tbody> <tr> <td>Single-sided mounting</td> <td></td> <td></td> </tr> <tr> <td>Double-sided mounting</td> <td></td> <td></td> </tr> </tbody> </table> <ol style="list-style-type: none"> As the alignment pin wears out, adjustment of the nozzle height can cause chipping or cracking of the inductors because of mechanical impact on the inductors. To avoid this, the monitoring of the width between the alignment pin in the stopped position, and maintenance, inspection and replacement of the pin should be conducted periodically. Some adhesives may cause reduced insulation resistance. The difference between the shrinkage percentage of the adhesive and that of the inductors may result in stresses on the inductors and lead to cracking. Moreover, too little or too much adhesive applied to the board may adversely affect component placement, so the following precautions should be noted in the application of adhesives. <ol style="list-style-type: none"> Required adhesive characteristics <ol style="list-style-type: none"> The adhesive should be strong enough to hold parts on the board during the mounting & solder process. The adhesive should have sufficient strength at high temperatures. The adhesive should have good coating and thickness consistency. The adhesive should be used during its prescribed shelf life. The adhesive should harden rapidly The adhesive must not be contaminated. The adhesive should have excellent insulation characteristics. The adhesive should not be toxic and have no emission of toxic gasses. 		Improper method	Proper method	Single-sided mounting			Double-sided mounting		
	Improper method	Proper method									
Single-sided mounting											
Double-sided mounting											

Precautions on the use of Multilayer chip Inductors, Multilayer chip inductors for high frequency, Multilayer ferrite chip beads

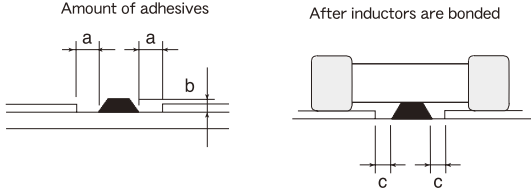
Stages	Precaution	Technical considerations								
<p>3. Considerations for automatic placement</p>		<p>When using adhesives to mount inductors on a PCB, inappropriate amounts of adhesive on the board may adversely affect component placement. Too little adhesive may cause the inductors to fall off the board during the solder process. Too much adhesive may cause defective soldering due excessive flow of adhesive on to the land or solder pad.</p> <p>[Recommended conditions]</p> <table border="1" data-bbox="907 430 1437 546"> <thead> <tr> <th>Figure</th> <th>0805 case sizes as examples</th> </tr> </thead> <tbody> <tr> <td>a</td> <td>0.3mm min</td> </tr> <tr> <td>b</td> <td>100 ~120 μm</td> </tr> <tr> <td>c</td> <td>Area with no adhesive</td> </tr> </tbody> </table> 	Figure	0805 case sizes as examples	a	0.3mm min	b	100 ~120 μm	c	Area with no adhesive
Figure	0805 case sizes as examples									
a	0.3mm min									
b	100 ~120 μm									
c	Area with no adhesive									
<p>4. Soldering</p>	<p>◆ Selection of Flux</p> <p>1. Since flux may have a significant effect on the performance of inductors, it is necessary to verify the following conditions prior to use;</p> <p>(1) Flux used should be with less than or equal to 0.1 wt% (Chlorine conversion method) of halogenated content. Flux having a strong acidity content should not be applied.</p> <p>(2) When soldering inductors on the board, the amount of flux applied should be controlled at the optimum level.</p> <p>(3) When using water-soluble flux, special care should be taken to properly clean the boards.</p> <p>◆ Soldering</p> <p>Temperature, time, amount of solder, etc. are specified in accordance with the following recommended conditions.</p>	<p>1-1. When too much halogenated substance (Chlorine, etc.) content is used to activate the flux, or highly acidic flux is used, an excessive amount of residue after soldering may lead to corrosion of the terminal electrodes or degradation of insulation resistance on the surface of the Inductor.</p> <p>1-2. Flux is used to increase solderability in flow soldering, but if too much is applied, a large amount of flux gas may be emitted and may detrimentally affect solderability. To minimize the amount of flux applied, it is recommended to use a flux-bubbling system.</p> <p>1-3. Since the residue of water-soluble flux is easily dissolved by water content in the air, the residue on the surface of Inductor in high humidity conditions may cause a degradation of insulation resistance and therefore affect the reliability of the components. The cleaning methods and the capability of the machines used should also be considered carefully when selecting water-soluble flux.</p> <p>1-1. Preheating when soldering</p> <p>Heating: Chip inductor components should be preheated to within 100 to 130°C of the soldering. Cooling: The temperature difference between the components and cleaning process should not be greater than 100 °C. Chip inductors are susceptible to thermal shock when exposed to rapid or concentrated heating or rapid cooling. Therefore, the soldering process must be conducted with a great care so as to prevent malfunction of the components due to excessive thermal shock.</p>								

Precautions on the use of Multilayer chip Inductors, Multilayer chip inductors for high frequency, Multilayer ferrite chip beads

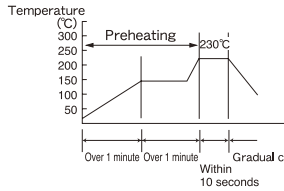
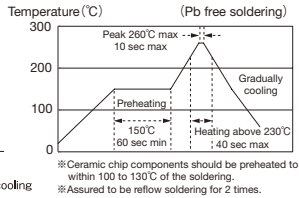
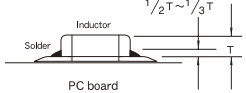
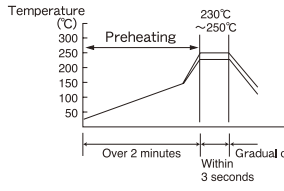
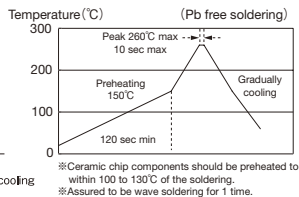
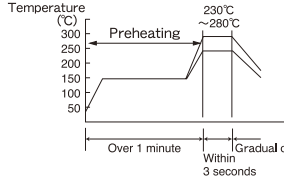
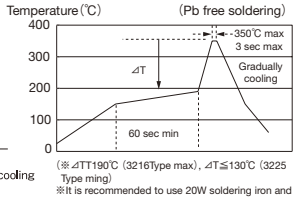
Stages	Precautions	Technical considerations
4.Soldering	<p>◆And please contact us about peak temperature when you use lead-free paste.</p>	<p>Recommended conditions for soldering</p> <p>[Reflow soldering]</p> <p>Temperature profile</p>   <p>※Ceramic chip components should be preheated to within 100 to 130°C of the soldering. ※Assured to be reflow soldering for 2 times.</p> <p>Cautions</p> <ol style="list-style-type: none"> The ideal condition is to have solder mass (fillet) controlled to 1/2 to 1/3 of the thickness of the inductor, as shown below:  <ol style="list-style-type: none"> Because excessive dwell times can detrimentally affect solderability, soldering duration should be kept as close to recommended times as possible. <p>[Wave soldering]</p> <p>Temperature profile</p>   <p>※Ceramic chip components should be preheated to within 100 to 130°C of the soldering. ※Assured to be wave soldering for 1 time. ※Except for reflow soldering type.</p> <p>Cautions</p> <ol style="list-style-type: none"> Make sure the inductors are preheated sufficiently. The temperature difference between the inductor and melted solder should not be greater than 100 to 130°C Cooling after soldering should be as gradual as possible. Wave soldering must not be applied to the inductors designated as for reflow soldering only. <p>[Hand soldering]</p> <p>Temperature profile</p>   <p>※ΔT190°C (3216Type max), ΔT≦130°C (3225 Type ming) ※It is recommended to use 20W soldering iron and the tip is 1φ or less. ※The soldering iron should not directly touch the components. ※Assured to be soldering iron for 1 time.</p> <p>Note: The above profiles are the maximum allowable soldering condition, therefore these profiles are not always recommended.</p> <p>Cautions</p> <ol style="list-style-type: none"> Use a 20W soldering iron with a maximum tip diameter of 1.0 mm. The soldering iron should not directly touch the inductor.
5.Cleaning	<p>◆Cleaning conditions</p> <ol style="list-style-type: none"> When cleaning the PC board after the Inductors are all mounted, select the appropriate cleaning solution according to the type of flux used and purpose of the cleaning (e.g. to remove soldering flux or other materials from the production process.) 	<ol style="list-style-type: none"> The use of inappropriate solutions can cause foreign substances such as flux residue to adhere to the inductor, resulting in a degradation of the inductor's electrical properties (especially insulation resistance).

Precautions on the use of Multilayer chip Inductors, Multilayer chip inductors for high frequency, Multilayer ferrite chip beads

Stages	Precautions	Technical considerations						
5. Cleaning	<p>2. Cleaning conditions should be determined after verifying, through a test run, that the cleaning process does not affect the inductor's characteristics.</p>	<p>2. Inappropriate cleaning conditions (insufficient or excessive cleaning) may detrimentally affect the performance of the inductors.</p> <p>(1) Excessive cleaning In the case of ultrasonic cleaning, too much power output can cause excessive vibration of the PC board which may lead to the cracking of the inductor or the soldered portion, or decrease the terminal electrodes' strength. Thus the following conditions should be carefully checked;</p> <table border="0" style="width: 100%;"> <tr> <td style="padding-right: 20px;">Ultrasonic output</td> <td>Below 20 w/l</td> </tr> <tr> <td>Ultrasonic frequency</td> <td>Below 40 kHz</td> </tr> <tr> <td>Ultrasonic washing period</td> <td>5 min. or less</td> </tr> </table>	Ultrasonic output	Below 20 w/l	Ultrasonic frequency	Below 40 kHz	Ultrasonic washing period	5 min. or less
Ultrasonic output	Below 20 w/l							
Ultrasonic frequency	Below 40 kHz							
Ultrasonic washing period	5 min. or less							
6. Post cleaning processes	<p>◆ Application of resin coatings, moldings, etc. to the PCB and components.</p> <p>1. With some type of resins a decomposition gas or chemical reaction vapor may remain inside the resin during the hardening period or while left under normal storage conditions resulting in the deterioration of the inductor's performance.</p> <p>2. When a resin's hardening temperature is higher than the inductor's operating temperature, the stresses generated by the excess heat may lead to inductor damage or destruction.</p> <p>3. Stress caused by a resin's temperature generated expansion and contraction may damage inductors.</p> <p>The use of such resins, molding materials etc. is not recommended.</p>							
7. Handling	<p>◆ Breakaway PC boards (splitting along perforations)</p> <p>1. When splitting the PC board after mounting inductors and other components, care is required so as not to give any stresses of deflection or twisting to the board.</p> <p>2. Board separation should not be done manually, but by using the appropriate devices.</p> <p>◆ General handling precautions</p> <ol style="list-style-type: none"> 1. Always wear static control bands to protect against ESD. 2. Keep the inductors away from all magnets and magnetic objects. 3. Use non-magnetic tweezers when handling inductors. 4. Any devices used with the inductors (soldering irons, measuring instruments) should be properly grounded. 5. Keep bare hands and metal products (i.e., metal desk) away from chip electrodes or conductive areas that lead to chip electrodes. 6. Keep inductors away from items that generate magnetic fields such as speakers or coils. <p>◆ Mechanical considerations</p> <ol style="list-style-type: none"> 1. Be careful not to subject the inductors to excessive mechanical shocks. <ol style="list-style-type: none"> (1) If inductors are dropped on the floor or a hard surface they should not be used. (2) When handling the mounted boards, be careful that the mounted components do not come in contact with or bump against other boards or components. 							

Precautions on the use of Multilayer chip Inductors, Multilayer chip inductors for high frequency, Multilayer ferrite chip beads

Stages	Precautions	Technical considerations				
8. Storage conditions	<p>◆Storage</p> <p>1. To maintain the solderability of terminal electrodes and to keep the packaging material in good condition, care must be taken to control temperature and humidity in the storage area. Humidity should especially be kept as low as possible.</p> <p>Recommended conditions</p> <table border="0" data-bbox="423 432 781 478"> <tr> <td>Ambient temperature</td> <td>Below 40 °C</td> </tr> <tr> <td>Humidity</td> <td>Below 70% RH</td> </tr> </table> <p>The ambient temperature must be kept below 30 °C. Even under ideal storage conditions inductor electrode solderability decreases as time passes, so inductors should be used within 6 months from the time of delivery.</p> <p>*The packaging material should be kept where no chlorine or sulfur exists in the air.</p>	Ambient temperature	Below 40 °C	Humidity	Below 70% RH	<p>1. If the parts are stocked in a high temperature and humidity environment, problems such as reduced solderability caused by oxidation of terminal electrodes and deterioration of taping/packaging materials may take place. For this reason, components should be used within 6 months from the time of delivery. If exceeding the above period, please check solderability before using the inductors</p>
Ambient temperature	Below 40 °C					
Humidity	Below 70% RH					

角チップフェーズインダクタ

RECTANGULAR FERRITE CHIP BEADS (HIGH CURRENT)

FB SERIES M TYPE



OPERATING TEMP. -40~+85°C

フロー/WAVE

リフロー/REFLOW

特長 FEATURES

電源部で使用可能

- ・耐大電流(定格電流6A)
- ・耐高エネルギー
- ・高信頼性

FBMJタイプは様々なバリエーションをラインナップ

HS : 広帯域対応
HM : 高帯域対応
HL : GHz対応

FBMHタイプは、電源ラインのケーブル輻射ノイズ等、高インピーダンス、大電流を要する回路に最適

Power supply units:
Large withstand voltage (allowable current: up to 6 A)
Resistance to high energy
High reliability

There are several variations of the FBMJ type
HS: For broadband applications
HM: For upper MHz range applications
HL: For GHz range applications

The FBMH type are optimal for circuit designs which require high impedances and large currents to combat radiated noise on power lines, etc.

用途 APPLICATIONS

- ・電源ラインの輻射・伝導ノイズ対策
- ・各種デジタル機器におけるデジタル信号の波形整形、データラインの高周波ノイズ対策
- ・電装機器
- ・OA機器
- ・USB等の差動伝送ライン
- ・低消費電力化が要求される携帯機器

- ・ Deals with power line radiated and conducted noise.
- ・ Provides waveform correction of digital signals and high frequency noise countermeasures in various types of digital equipment.
- ・ Automotive
- ・ Computer Peripherals
- ・ Differential transmission line on USB and similar products
- ・ Mobile devices which require lower power consumption

形名表記法 ORDERING CODE

1 形式	FB フェライトフェーズインダクタ	3 特性区分	J 標準品 H 高インピーダンス品	4 外形寸法 (L×W) [mm]	1608 (0603) 1.6×0.8 2125 (0805) 2.0×1.25 2012 (0805) 2.0×1.25 2016 (0806) 2.0×1.6 3216 (1206) 3.2×1.6 3225 (1210) 3.2×2.5 4516 (1806) 4.5×1.6 4525 (1810) 4.5×2.5 4532 (1812) 4.5×3.2	5 材質コード	HS 材質によりインピーダンス特性が異なる HM HL	7 インピーダンス許容差	- ± 25% N ± 30%
2 形状	M 角形チップ			6 公称インピーダンス [Ω]	例 330 33 111 110 132 1300	8 梱包仕様	T テーピング	9 当社管理記号	△ 標準品 △=スペース



1 Type	FB Ferrite bead	3 Product characteristics	J Standard type H High Impedance type	4 External Dimensions (L×W) [mm]	1608 (0603) 1.6×0.8 2125 (0805) 2.0×1.25 2012 (0805) 2.0×1.25 2016 (0806) 2.0×1.6 3216 (1206) 3.2×1.6 3225 (1210) 3.2×2.5 4516 (1806) 4.5×1.6 4525 (1810) 4.5×2.5 4532 (1812) 4.5×3.2	5 Material code	HS Refer to impedance curves for material difference HM HL	7 Impedance Tolerance	- ± 25% N ± 30%
2 Shape	M Rectangular chip			6 Nominal Impedance [Ω]	example 330 33 111 110 132 1300	8 Packaging	T Tape&Reel	9 Internal code	△ Standard product △=Blank space

外形寸法 EXTERNAL DIMENSIONS

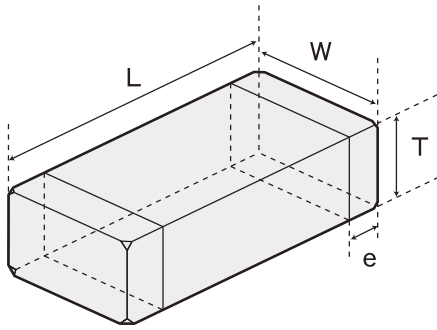

Type	L	W	T	e
FBMJ1608 (0603)	1.6 ± 0.2 (0.063 ± 0.008)	0.8 ± 0.2 (0.031 ± 0.008)	0.8 ± 0.2 (0.031 ± 0.008)	0.3 ± 0.2 (0.012 ± 0.008)
FBMJ2125 (0805)	2.0 ± 0.2 (0.079 ± 0.008)	1.25 ± 0.2 (0.049 ± 0.008)	0.85 ± 0.2 (0.033 ± 0.008)	0.5 ± 0.3 (0.020 ± 0.012)
FBMJ3216 (1206)	3.2 ± 0.3 (0.126 ± 0.012)	1.6 ± 0.2 (0.063 ± 0.008)	1.1 ± 0.2 (0.043 ± 0.008)	0.5 ± 0.3 (0.020 ± 0.012)
FBMJ4516 (1806)	4.5 ± 0.3 (0.177 ± 0.012)	1.6 ± 0.2 (0.063 ± 0.008)	1.1 ± 0.2 (0.043 ± 0.008)	0.5 ± 0.3 (0.020 ± 0.012)
FBMH1608 (0603)	1.6 ± 0.1 (0.063 ± 0.004)	0.8 ± 0.1 (0.031 ± 0.004)	0.8 ± 0.1 (0.031 ± 0.004)	0.3 ± 0.15 (0.012 ± 0.006)
FBMH2012 (0805)	2.0 ± 0.2 (0.079 ± 0.008)	1.25 ± 0.2 (0.049 ± 0.008)	0.85 ± 0.2 (0.033 ± 0.008)	0.5 ± 0.3 (0.020 ± 0.012)
FBMH2016 (0806)	2.0 ± 0.2 (0.079 ± 0.008)	1.6 ± 0.2 (0.063 ± 0.008)	1.6 ± 0.2 (0.063 ± 0.008)	0.5 ± 0.3 (0.020 ± 0.012)
FBMH3216 (1206)	3.2 ± 0.3 (0.126 ± 0.012)	1.6 ± 0.2 (0.063 ± 0.008)	1.6 ± 0.2 (0.063 ± 0.008)	0.5 ± 0.3 (0.020 ± 0.012)
FBMH3225 (1210)	3.2 ± 0.3 (0.126 ± 0.012)	2.5 ± 0.3 (0.098 ± 0.012)	2.5 ± 0.3 (0.098 ± 0.012)	0.5 ± 0.3 (0.020 ± 0.012)
FBMH4516 (1806)	4.5 ± 0.3 (0.177 ± 0.012)	1.6 ± 0.2 (0.063 ± 0.008)	1.6 ± 0.2 (0.063 ± 0.008)	0.5 ± 0.3 (0.020 ± 0.012)
FBMH4525 (1810)	4.5 ± 0.4 (0.177 ± 0.016)	2.5 ± 0.3 (0.098 ± 0.012)	2.5 ± 0.3 (0.098 ± 0.012)	0.9 ± 0.6 (0.035 ± 0.024)
FBMH4532 (1812)	4.5 ± 0.4 (0.177 ± 0.016)	3.2 ± 0.3 (0.126 ± 0.012)	3.2 ± 0.3 (0.126 ± 0.012)	0.9 ± 0.6 (0.035 ± 0.024)

Unit : mm (inch)

推奨ランドパターン Recommended Land Pattern Dimensions

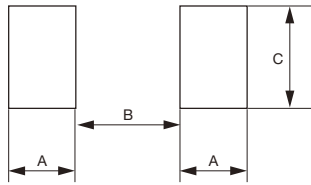

形名 Parts Number	寸法 Dimensions (mm)			形名 Parts Number	寸法 Dimensions (mm)		
	A	B	C		A	B	C
FB MJ1608タイプ (type)	1.0	1.0	1.0	FB MH2016タイプ (type)	1.4	1.2	2.0
FB MJ2125タイプ (type)	1.4	1.2	1.65	FB MH3216タイプ (type)	1.4	2.2	2.0
FB MJ3216タイプ (type)	1.4	2.2	2.0	FB MH4516タイプ (type)	1.75	3.5	2.0
FB MJ4516タイプ (type)	1.75	3.5	2.0	FB MH3225タイプ (type)	1.4	2.2	2.9
FB MH1608タイプ (type)	1.0	1.0	1.0	FB MH4525タイプ (type)	1.75	3.5	2.9
FB MH2012タイプ (type)	1.4	1.2	1.65	FB MH4532タイプ (type)	1.75	3.5	3.7

概略バリエーション AVAILABLE MATERIALS

標準品 (Standard Type)

FBMJ1608

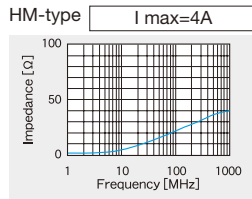
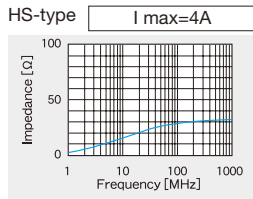

高インピーダンス品 (High impedance Type)

FBMH1608

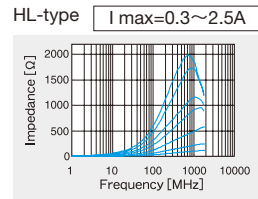
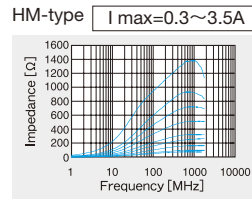

FBMJ2125

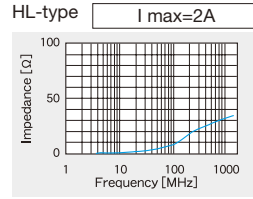
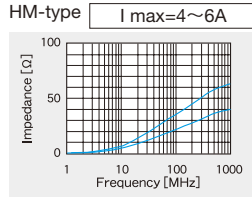
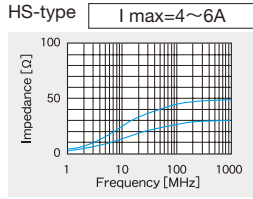

FBMH2016

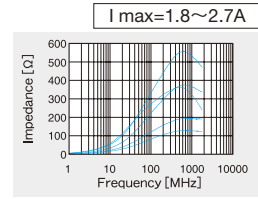

FBMJ3216

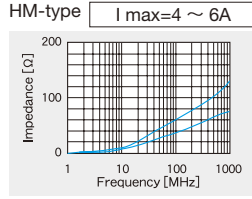
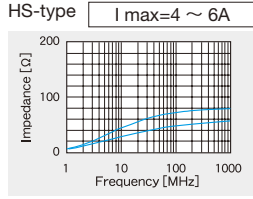

FBMH3216

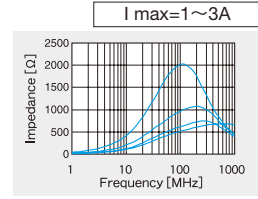

FBMJ4516

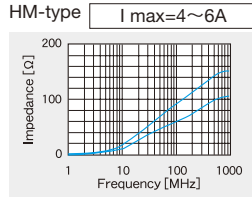
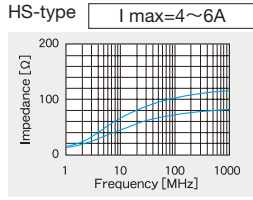

FBMH4516

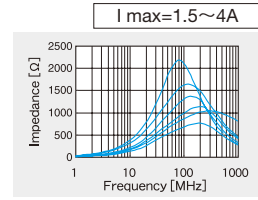

セクションガイド
Selection Guide

アイテム一覧
Part Numbers

特性図
Electrical Characteristics

梱包
Packaging

信頼性
Reliability Data

使用上の注意
Precautions



etc

アイテム一覧 PART NUMBERS

標準品 (Standard Type)

FBMJ1608

形名 Ordering code	EHS (Environmental Hazardous Substances)	インピーダンス Impedance [Ω]	インピーダンス 測定周波数 Measuring frequency [MHz]	直流抵抗 DC Resistance [Ω] max.	定格電流 Rated current [A] max.	厚み Thickness [mm] (inch)
FB MJ1608HS280NT	RoHS	28±30%	100	0.007	4.0	0.8±0.2 (0.031±0.008)
FB MJ1608HM230NT	RoHS	23±30%				

FBMJ2125

形名 Ordering code	EHS (Environmental Hazardous Substances)	インピーダンス Impedance [Ω]	インピーダンス 測定周波数 Measuring frequency [MHz]	直流抵抗 DC Resistance [Ω] max.	定格電流 Rated current [A] max.	厚み Thickness [mm] (inch)
FB MJ2125HS420-T	RoHS	42 ± 25%	100	0.008	4.0	0.85 ± 0.2 (0.033 ± 0.008)
FB MJ2125HS250NT	RoHS	25 ± 30%		0.004	6.0	
FB MJ2125HM330-T	RoHS	33 ± 25%		0.008	4.0	
FB MJ2125HM210NT	RoHS	21 ± 30%		0.004	6.0	
FB MJ2125HL8R0NT	RoHS	8 ± 30%		0.010	2.0	

FBMJ3216

形名 Ordering code	EHS (Environmental Hazardous Substances)	インピーダンス Impedance [Ω]	インピーダンス 測定周波数 Measuring frequency [MHz]	直流抵抗 DC Resistance [Ω] max.	定格電流 Rated current [A] max.	厚み Thickness [mm] (inch)
FB MJ3216HS800-T	RoHS	80±25%	100	0.010	4.0	1.1±0.2 (0.043±0.008)
FB MJ3216HS480NT	RoHS	48±30%		0.005	6.0	
FB MJ3216HM600-T	RoHS	60±25%		0.010	4.0	
FB MJ3216HM380NT	RoHS	38±30%		0.005	6.0	

FBMJ4516

形名 Ordering code	EHS (Environmental Hazardous Substances)	インピーダンス Impedance [Ω]	インピーダンス 測定周波数 Measuring frequency [MHz]	直流抵抗 DC Resistance [Ω] max.	定格電流 Rated current [A] max.	厚み Thickness [mm] (inch)
FB MJ4516HS111-T	RoHS	110±25%	100	0.014	4.0	1.1±0.2 (0.043±0.008)
FB MJ4516HS720NT	RoHS	72±30%		0.007	6.0	
FB MJ4516HM900-T	RoHS	90±25%		0.014	4.0	
FB MJ4516HM560NT	RoHS	56±30%		0.007	6.0	

高インピーダンス品 (High impedance Type)

形名 Ordering code	EHS (Environmental Hazardous Substances)	インピーダンス Impedance [Ω]	インピーダンス 測定周波数 Measuring frequency [MHz]	直流抵抗 DC Resistance [Ω]max.	定格電流 Rated current [A]max.	厚み Thickness [mm] (inch)
FB MH1608HM470-T	RoHS	47±25%	100	0.020	3.5	0.8±0.1 (0.031±0.004)
FB MH1608HM600-T	RoHS	60±25%		0.025	3.0	
FB MH1608HM101-T	RoHS	100±25%		0.035	2.0	
FB MH1608HM151-T	RoHS	150±25%		0.050	2.0	
FB MH1608HM221-T	RoHS	220±25%		0.070	1.5	
FB MH1608HM331-T	RoHS	330±25%		0.130	0.9	
FB MH1608HM471-T	RoHS	470±25%		0.150	0.7	
FB MH1608HM601-T	RoHS	600±25%		0.170	0.7	
FB MH1608HM102-T	RoHS	1000±25%		0.350	0.5	
FB MH1608HL300-T	RoHS	30±25%		0.028	2.5	
FB MH1608HL600-T	RoHS	60±25%		0.045	1.8	
FB MH1608HL121-T	RoHS	120±25%		0.130	0.9	
FB MH1608HL221-T	RoHS	220±25%		0.170	0.7	
FB MH1608HL331-T	RoHS	330±25%		0.210	0.6	
FB MH1608HL471-T	RoHS	470±25%		0.350	0.5	
FB MH1608HL601-T	RoHS	600±25%		0.450	0.4	
FB MH2012HM800-T	RoHS	80±25%		0.025	2.7	0.85±0.2 (0.033±0.008)
FB MH2012HM121-T	RoHS	120±25%		0.032	2.5	
FB MH2012HM221-T	RoHS	220±25%		0.060	2.0	
FB MH2012HM331-T	RoHS	330±25%		0.080	1.8	1.6±0.2 (0.063±0.008)
FB MH2016HM251NT	RoHS	250±30%		0.050	2.0	
FB MH3216HM501NT	RoHS	500±30%		0.070	2.0	2.5±0.3 (0.098±0.012)
FB MH4516HM851NT	RoHS	850±30%		0.100	1.5	
FB MH3225HM601NT	RoHS	600±30%		0.042	3.0	
FB MH3225HM102NT	RoHS	1000±30%		0.100	2.0	
FB MH3225HM202NT	RoHS	2000±30%		0.130	1.2	3.2±0.3 (0.126±0.012)
FB MH4525HM102NT	RoHS	1000±30%		0.060	3.0	
FB MH4525HM162NT	RoHS	1600±30%		0.130	2.0	
FB MH4532HM681-T	RoHS	680±25%	0.028	4.0		
FB MH4532HM132-T	RoHS	1300±25%	0.060	3.0	3.2±0.3 (0.126±0.012)	
FB MH4532HM202-T	RoHS	2000±25%	0.130	1.3		

標準品 (Standard Type)

FBMJ1608

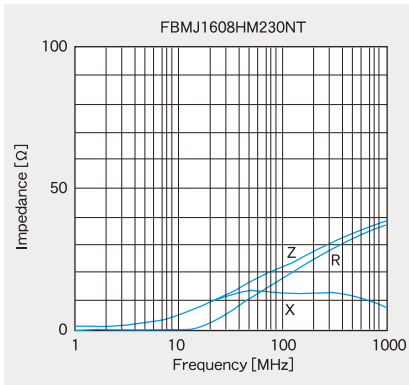
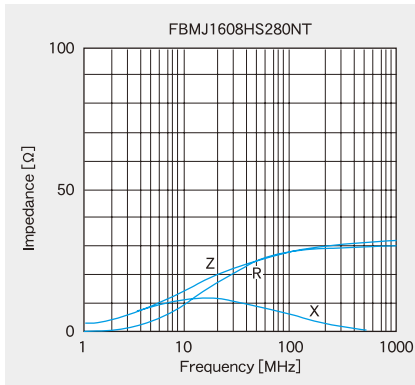

FBMJ2125

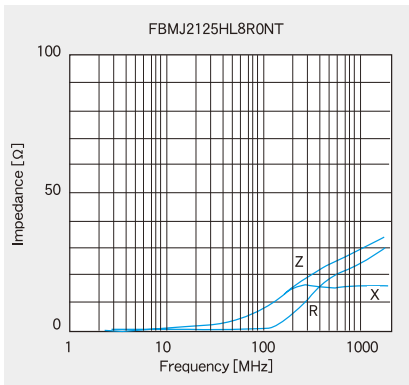
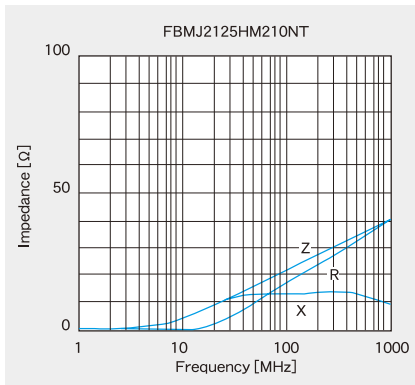
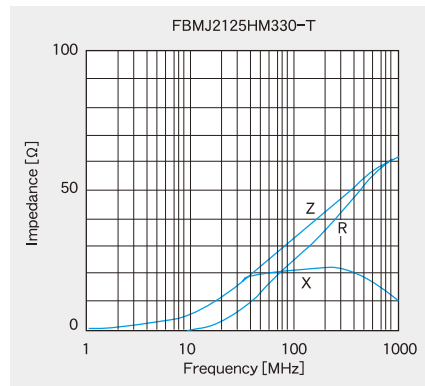
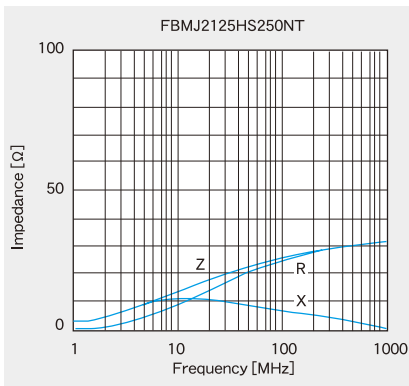
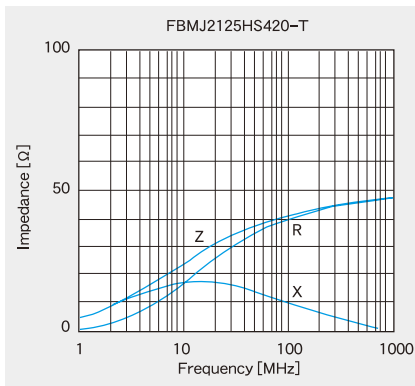

FBMJ3216

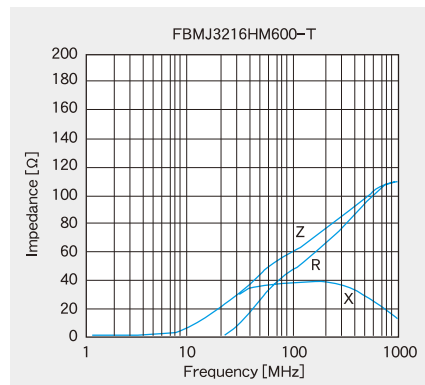
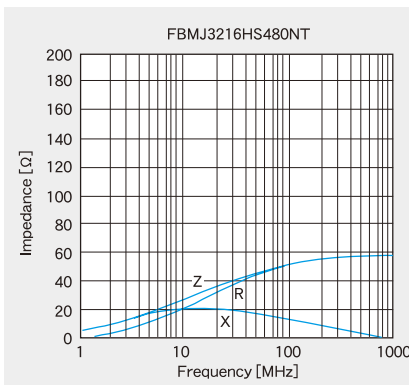
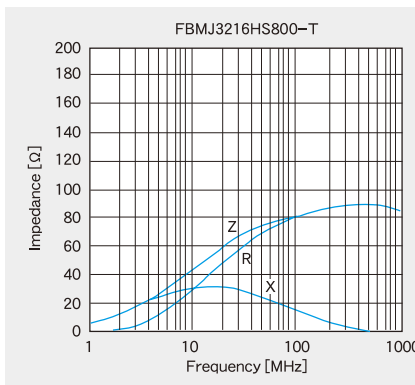

標準品 (Standard Type)

FBMJ3216

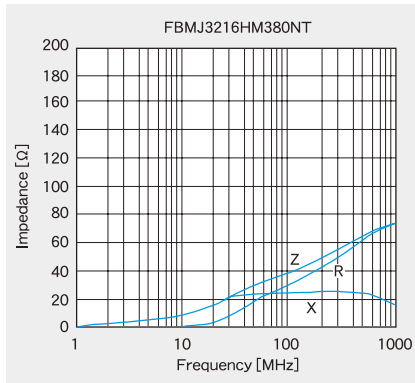

FBMJ4516

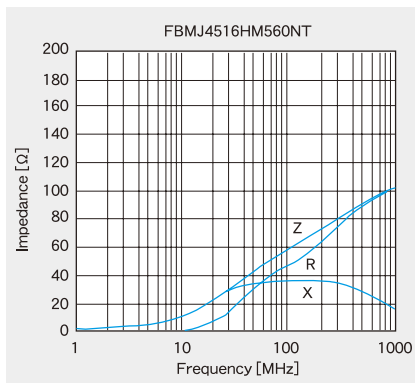
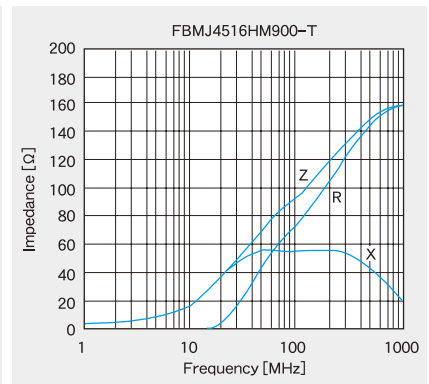
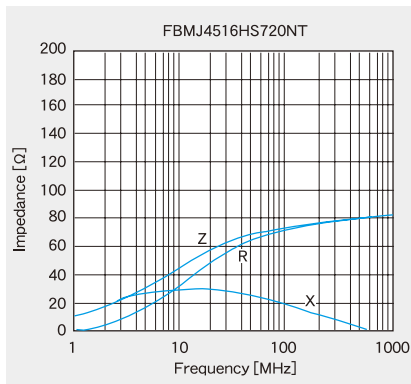
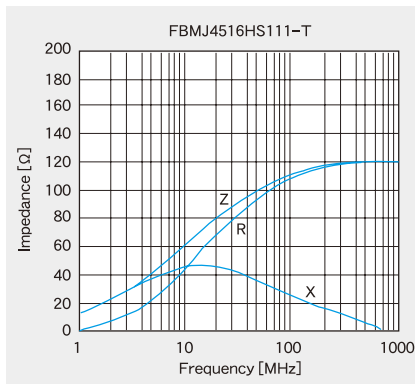

高インピーダンス品 (High impedance Type)

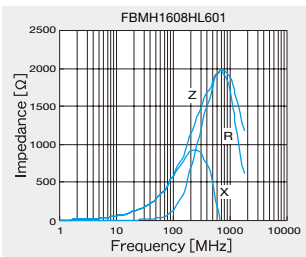
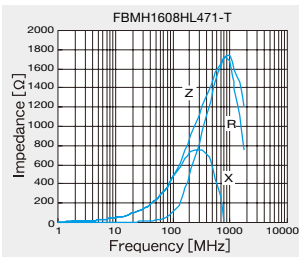
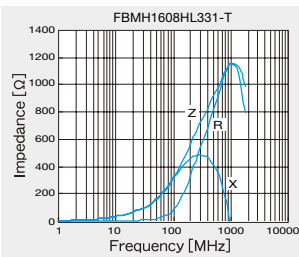
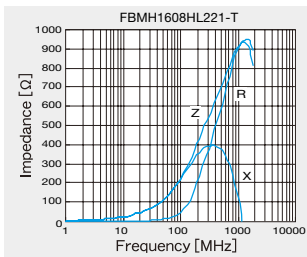
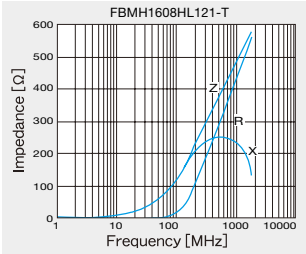
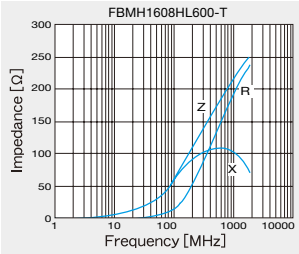
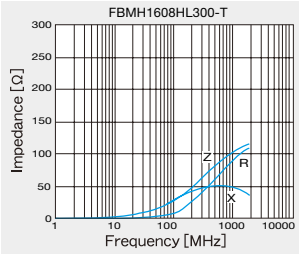
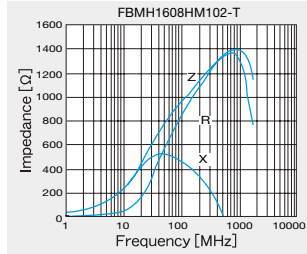
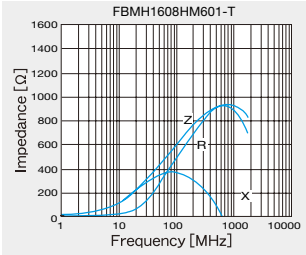
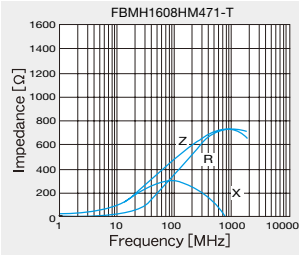
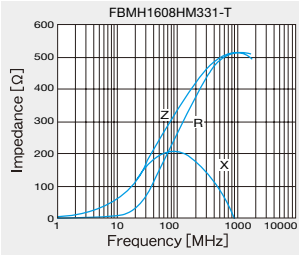
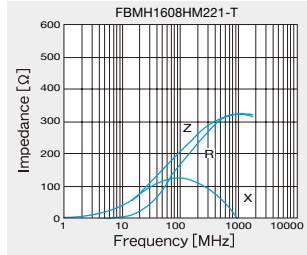
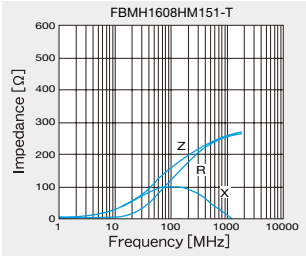
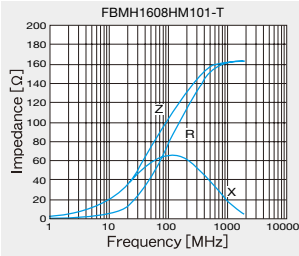
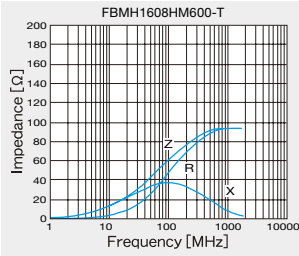
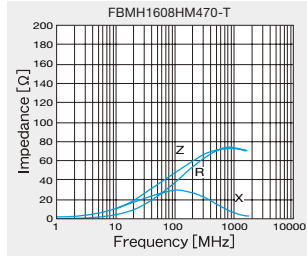

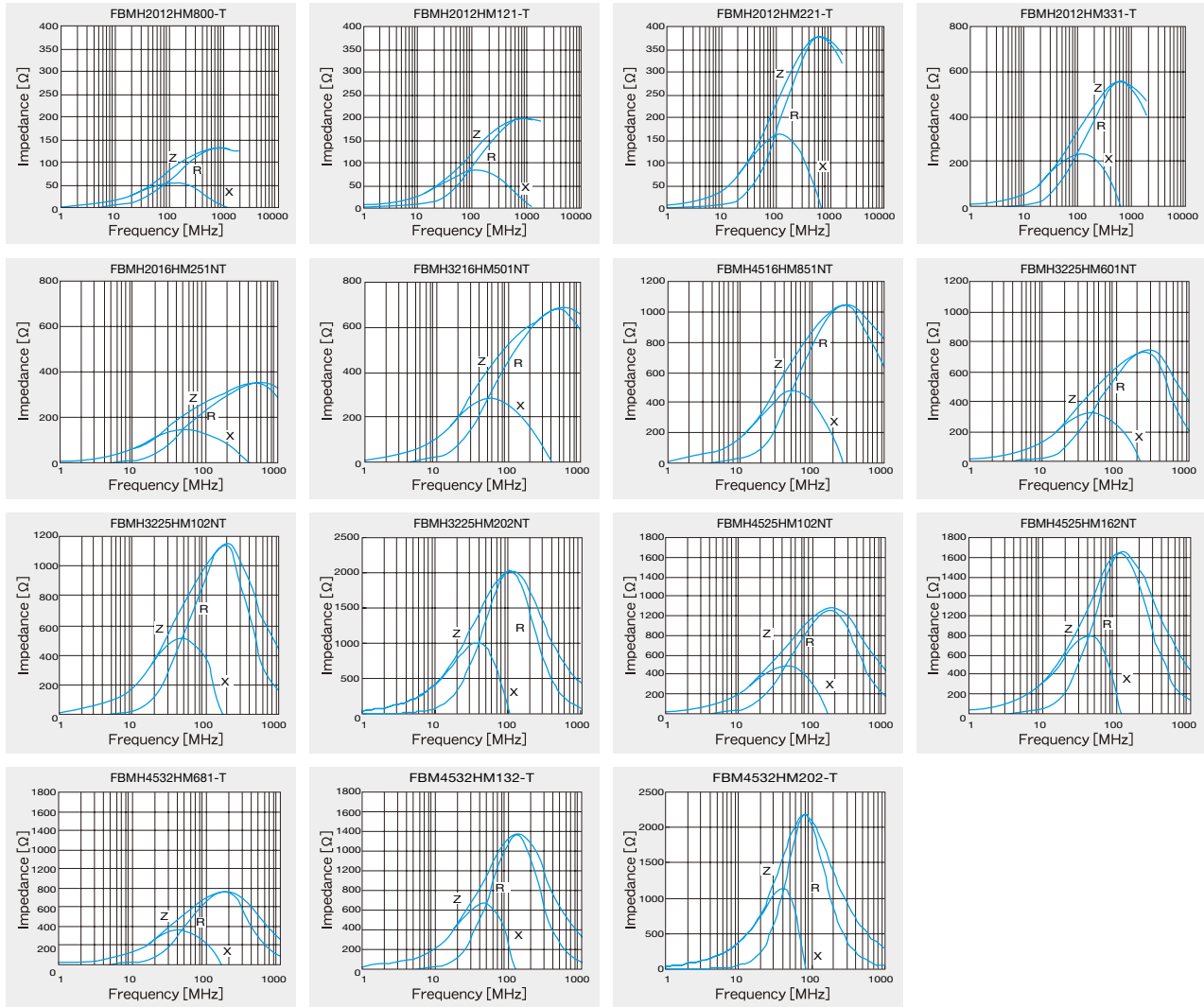

①最小受注単位数 Minimum Quantity

Type	標準数量 Standard Quantity [pcs]	
	紙テーピング Paper Tape	エンボステーピング Embossed Tape
1608 (0603)	4000	—
2125 (0805)	4000	—
2012 (0805)	4000	—
2016 (0806)	—	2000
3216 (1206)	—	2000
4516 (1806)	—	2000
3225 (1210)	—	1000
4525 (1810)	—	1000
4532 (1812)	—	2000

②テーピング材質 Tape Material

紙テープ

Card board carrier tape

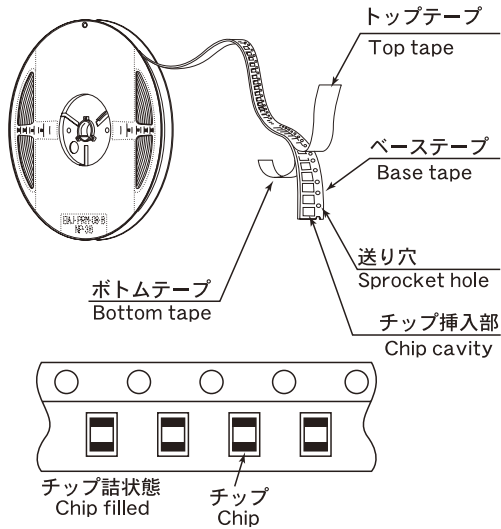

エンボステープ
Embossed Tape

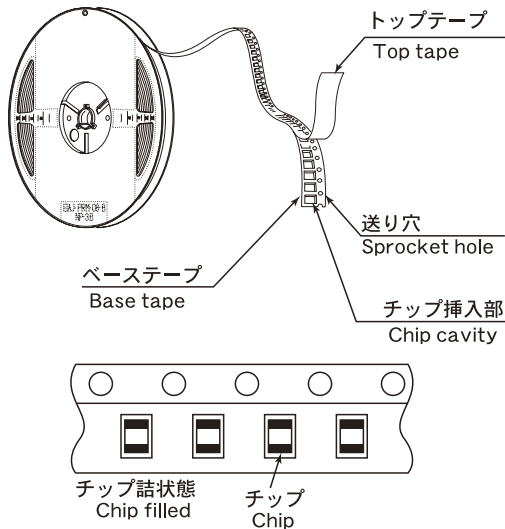

③テープ寸法 Taping Dimensions

紙テープ (8mm幅) Paper tape (0.315 inches wide)

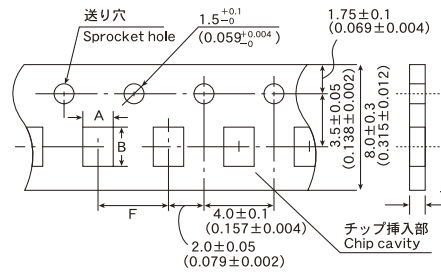

形式 Type	チップ挿入部 Chip Cavity		挿入ピッチ Insertion Pitch	テープ厚み Tape Thickness
	A	B	F	T
FBMJ1608 FBMH1608 (0603)	1.0 ^{±0.2} (0.039 ^{±0.008})	1.8 ^{±0.2} (0.071 ^{±0.008})	4.0 ^{±0.2} (0.157 ^{±0.008})	1.1max (0.043max)
FBMJ2125 FBMH2012 (0805)	1.5 ^{±0.2} (0.059 ^{±0.008})	2.3 ^{±0.2} (0.091 ^{±0.008})	4.0 ^{±0.2} (0.157 ^{±0.008})	1.1max (0.043max)

Unit : mm (inch)

エンボステープ (8mm幅) Embossed tape (0.315 inches wide)

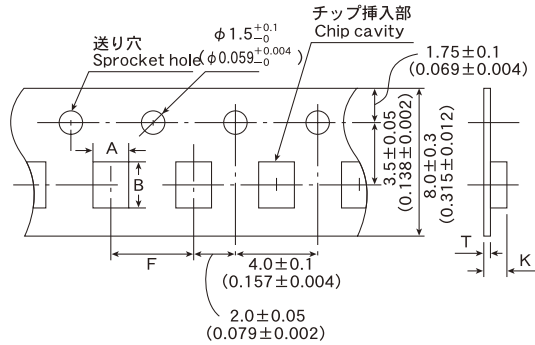

形式 Type	チップ挿入部 Chip Cavity		挿入ピッチ Insertion Pitch	テープ厚み Tape Thickness	
	A	B	F	K	T
FBMJ2016 FBMH2016 (0806)	1.8 ^{±0.2} (0.071 ^{±0.008})	2.2 ^{±0.2} (0.087 ^{±0.008})	4.0 ^{±0.2} (0.157 ^{±0.008})	2.6max (0.102max)	0.6max (0.024max)
FBMJ3216 (1206)	1.9 ^{±0.2} (0.075 ^{±0.008})	3.5 ^{±0.2} (0.138 ^{±0.008})	4.0 ^{±0.2} (0.157 ^{±0.008})	1.5max (0.059max)	0.3max (0.012max)
FBMJ3216 (1206)	1.9 ^{±0.2} (0.075 ^{±0.008})	3.5 ^{±0.2} (0.138 ^{±0.008})	4.0 ^{±0.2} (0.157 ^{±0.008})	2.6max (0.102max)	0.6max (0.024max)
FBMJ3225 (1210)	2.8 ^{±0.2} (0.110 ^{±0.008})	3.5 ^{±0.2} (0.138 ^{±0.008})	4.0 ^{±0.2} (0.157 ^{±0.008})	4.0max (0.157max)	0.6max (0.024max)

Unit : mm (inch)

エンボステープ (12mm幅) Embossed tape (0.472 inches wide)

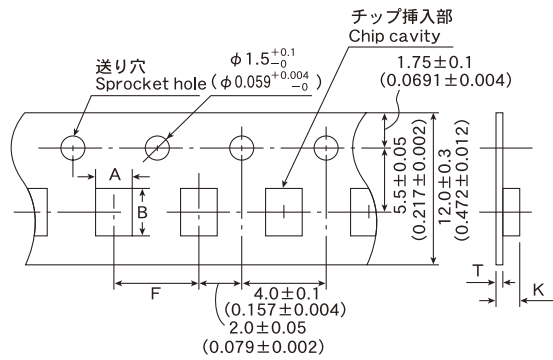

形式 Type	チップ挿入部 Chip cavity		挿入ピッチ Insertion pitch F	テープ厚み Tape Thickness	
	A	B		K	T
FBMJ4516 (1806)	1.9 ± 0.2 (0.075 ± 0.008)	4.9 ± 0.2 (0.193 ± 0.008)	4.0 ± 0.2 (0.157 ± 0.008)	1.5_{max} (0.059_{max})	0.3_{max} (0.012_{max})
FBMH4516 (1806)	1.9 ± 0.2 (0.075 ± 0.008)	4.9 ± 0.2 (0.193 ± 0.008)	4.0 ± 0.2 (0.157 ± 0.008)	2.6_{max} (0.102_{max})	0.6_{max} (0.024_{max})
FBMH4525 (1810)	2.9 ± 0.2 (0.114 ± 0.008)	4.9 ± 0.2 (0.193 ± 0.008)	4.0 ± 0.2 (0.157 ± 0.008)	4.0_{max} (0.157_{max})	0.6_{max} (0.024_{max})
FBMH4532 (1812)	3.6 ± 0.2 (0.142 ± 0.008)	4.9 ± 0.2 (0.193 ± 0.008)	8.0 ± 0.2 (0.315 ± 0.008)	4.0_{max} (0.157_{max})	0.6_{max} (0.024_{max})

Unit : mm (inch)

④リーダー部・空部 Leader and Blank portion

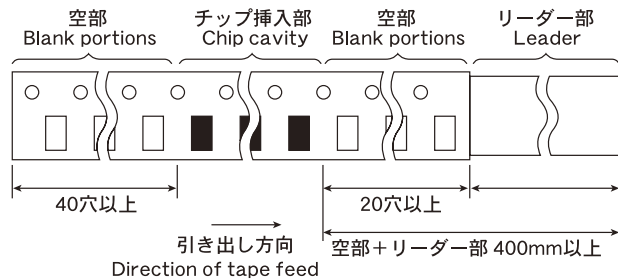

Insertion leader is 400 mm or more (including 20 empty cavities)
 Empty cavities at end of reel: 40 holes or more

⑤リール寸法 Reel size

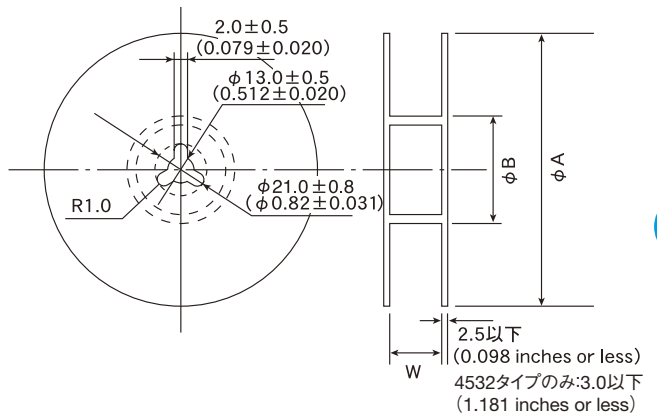

形式 Type	ϕA [mm] (inch)	ϕB [mm] (inch)	W [mm] (inch)
FBMJ1608	180^{+0}_{-3} ($7.09^{+0}_{-0.118}$)	60^{+1}_{-0} ($2.36^{+0.039}_{-0}$)	10.0 ± 1.5 (0.394 ± 0.047)
FBMJ2125			14.0 ± 1.5 (0.551 ± 0.059)
FBMJ3216			
FBMJ4516			10.0 ± 1.5 (0.394 ± 0.047)
FBMH1608			
FBMH2012			
FBMH2016			
FBMH3216	14.0 ± 1.5 (0.551 ± 0.059)		
FBMH3225			
FBMH4516			
FBMH4525	330 ± 2.0 (12.99 ± 0.080)	100 ± 1.0 (3.94 ± 0.039)	14 ± 2.0 (0.551 ± 0.080)
FBMH4532			

⑥トップテープ強度 Top tape strength

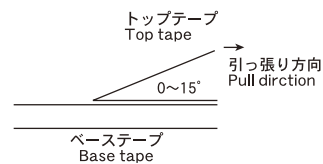

トップテープのはがし力は、下図矢印方向にて0.1~0.7Nとなります。
 The top tape requires a peel-off force of 0.1 to 0.7N in the direction of the arrow as illustrated below.

RECTANGULAR FERRITE CHIP BEADS (HIGH CURRENT) FB series M type

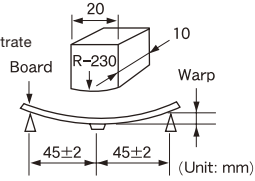
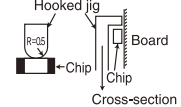
Item	Specified Value	Test Methods and Remarks															
1.Operating Temperature Range	-40~+85°C																
2.Storage Temperature Range	-40~+85°C	*Note: 0 to +40°C in taped packaging															
3.Impedance	Within the specified tolerance	Measuring equipment: Impedance analyzer (HP4291A) or its equivalent Measuring frequency: 100±1 MHz															
4. DC Resistance	Within the specified range	Four-terminal method Measuring equipment: Milliohm High-Tester 3226 (Hioki Denki) or its equivalent															
5.Rated Current	Within the specified range																
6.Vibration	Appearance: No significant abnormality Impedance change: Within ±30% of the initial value	According to JIS C 0040. Vibration type: A Directions: 2 hrs each in X,Y, and Z directions Total: 6 hrs Frequency range: 10 to 55 to 10Hz(/min.) Amplitude: 1.5 mm (shall not exceed acceleration 196m/s ²) Mounting method: Soldering onto PC board															
7. Solderability	75% or more of immersed surface of terminal electrode shall be covered with fresh solder.	Solder temperature: 230±5°C Duration: 4±1 sec. Preconditioning: Immersion into flux. Immersion and Removal speed: 25mm/sec.															
8.Resistance to Solder Heat	Appearance: No significant abnormality Impedance change: Within ±30% of the initial value	Preheating: 150°C for 3 min. Solder temperature: 260±5°C Duration: 10±0.5sec Preconditioning: Immersion into flux. Immersion and Removal speed: 25 mm/sec. Recovery: 2 to 3 hrs of recovery under the standard condition after the test.															
9.Thermal Shock	Appearance: No significant abnormality Impedance change: Within \pm_{-10}^{+50} % of the initial value	According to JIS C 0025. Conditions for 1 cycle <table border="1"> <thead> <tr> <th>Step</th> <th>Temperature(°C)</th> <th>Duration(min.)</th> </tr> </thead> <tbody> <tr> <td>1</td> <td>-40±3°C</td> <td>30±3</td> </tr> <tr> <td>2</td> <td>Room Temperature</td> <td>Within 3</td> </tr> <tr> <td>3</td> <td>85±2°C</td> <td>30±3</td> </tr> <tr> <td>4</td> <td>Room Temperature</td> <td>Within 3</td> </tr> </tbody> </table> Number of cycles: 100 Mounting method: Soldering onto PC board Recovery: 2 to 3 hrs of recovery under the standard condition after the removal from test chamber.	Step	Temperature(°C)	Duration(min.)	1	-40±3°C	30±3	2	Room Temperature	Within 3	3	85±2°C	30±3	4	Room Temperature	Within 3
Step	Temperature(°C)	Duration(min.)															
1	-40±3°C	30±3															
2	Room Temperature	Within 3															
3	85±2°C	30±3															
4	Room Temperature	Within 3															
10.Humidity (steady state)	Appearances: No significant abnormality Impedance change: Within ±30% of the initial value	Temperature: 40±2°C Humidity: 90 to 95%RH Duration: 500 $^{+24}_{-0}$ hrs Mounting method: Soldering onto PC board Recovery: 2 to 3 hrs of recovery under the standard condition after the removal from test chamber.															
11.Loading under Damp Heat	Appearance : No significant abnormality Impedance change : Within ±30% of the initial value	Temperature : 40±2°C Humidity : 90 to 95%RH Applied current : Rated current Duration : 500 $^{+24}_{-0}$ hrs Mounting method : Soldering onto PC board Recovery : 2 to 3hrs of recovery under the standard condition after the removal from test chamber.															
12.High Temperature Loading Test	Appearance: No significant abnormality Impedance change: Within ±30% of the initial value	Temperature: 85±2°C Duration: 500 $^{+24}_{-0}$ hrs Applied current: Rated current Mounting method: Soldering onto PC board Recovery: 2 to 3 hrs of recovery under the standard condition after the removal from test chamber.															
13.Resistance to Flexure of Substrate	No mechanical damage.	Warp: 2mm Testing board: Glass epoxy-resin substrate Thickness: 0.8mm 															
14.Adhesion of Electrode	No separation or indication of separation of electrode.	Applied force: 5N Duration: 10 sec. 															

Note on standard condition: "standard condition" referred to herein is defined as follows 5 to 35°C of temperature, 45 to 85% relative humidity and 86 to 106kPa of air pressure.
When there are questions concerning measurement results: In order to provide correlation data, the test shall be conducted under condition of 20±2°C of temperature, 60 to 70% relative humidity and 86 to 106kPa of air pressure.
Unless otherwise specified, all the tests are conducted under the "standard condition."

FBM Type

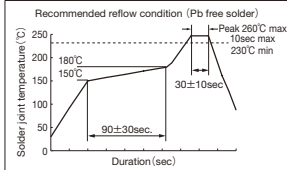
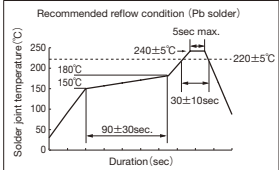
Stages	Precautions	Technical considerations
1.Circuit Design	<p>Operating environment,</p> <p>1.The products described in this specification are intended for use in general electronic equipment,(office supply equipment, telecommunications systems, measuring equipment, and household equipment). They are not intended for use in mission-critical equipment or systems requiring special quality and high reliability (traffic systems, safety equipment, aerospace systems, nuclear control systems and medical equipment including life-support systems,) where product failure might result in loss of life, injury or damage. For such uses, contact TAIYO YUDEN Sales Department in advance.</p> <p>Rated current</p> <p>1.Rated current of this product is shown in this catalogue, but please be sure to have the base board designed with adequate inspection in case of the generation of heat becomes high within the rated current range when the base board is in high resistance or in bad heating conditions.</p>	
2.PCB Design	<p>Land pattern design</p> <p>1.Please refer to a recommended land pattern.</p>	
3.Considerations for automatic placement	<p>Adjustment of mounting machine</p> <p>1.Excessive impact load should not be imposed on the products when mounting onto the PC boards.</p> <p>2.Mounting and soldering conditions should be checked beforehand.</p>	<p>1.When installing products, care should be taken not to apply distortion stress as it may deform the products.</p>
4.Soldering	<p>Wave soldering</p> <p>1.Please refer to the specifications in the catalog for a wave soldering.</p> <p>Reflow soldering</p> <p>1.Please contact any of our offices for a reflow soldering, and refer to the recommended condition specified.</p> <p>Lead free soldering</p> <p>1.When using products with lead free soldering, we request to use them after confirming of adhesion, temperature of resistance to soldering heat, etc. sufficiently.</p> <p>Preheating when soldering</p> <p>Heating:The temperature difference between soldering and remaining heat should not be greater than 150°C.</p> <p>Cooling:The temperature difference between the components and cleaning process should not be greater than 100°C.</p> <p>Recommended conditions for using a soldering iron</p> <p>Put the soldering iron on the land-pattern.</p> <p>Soldering iron's temperature - Below 350°C</p> <p>Duration - 3 seconds or less</p> <p>The soldering iron should not directly touch the inductor.</p>	<p>1.If products are used beyond the range of the recommended conditions, heat stresses may deform the products, and consequently degrade the reliability of the products.</p> <div style="display: flex; justify-content: space-around;">   </div> <p>1.There is a case that products get damaged by a heat shock.</p> <p>1.If products are used beyond the range of the recommended conditions, heat stresses may deform the products, and consequently degrade the reliability of the products</p>

FBM Type

Stages	Precautions	Technical considerations
5.Handling	<p>Handling</p> <p>1.Keep the inductors away from all magnets and magnetic objects.</p> <p>Setting PC boards</p> <p>1.When setting a chip mounted base board, please make sure that there is no residual stress to the chip by distortion in the board or at screw part.</p> <p>Breakaway PC boards (splitting along perforations)</p> <p>1.When splitting the PC board after mounting inductors, care should be taken not to give any stresses of deflection or twisting to the board.</p> <p>2.Board separation should not be done manually, but by using the appropriate devices.</p> <p>Mechanical considerations</p> <p>1.Please do not give the inductors any excessive mechanical shocks.</p>	<p>1.There is a case that a characteristic varies with magnetic influence.</p> <p>1.There is a case that a characteristic varies with residual stress.</p> <p>1.Planning pattern configurations and the position of products should be carefully performed to minimize stress.</p> <p>1.There is a case to be damaged by a mechanical shock.</p>
6.Storage conditions	<p>Storage</p> <p>1.To maintain the solderability of terminal electrodes and to keep the packing material in good condition, temperature and humidity in the storage area should be controlled..</p> <p>•Recommended conditions</p> <p>Ambient temperature 0~40°C</p> <p>Humidity Below 70% RH</p> <p>The ambient temperature must be kept below 30°C. Even under ideal storage conditions, solderability of products electrodes may decrease as time passes. For this reason, inductors should be used within 6 months from the time of delivery.</p>	<p>1. Under a high temperature and humidity environment, problems such as reduced solderability caused by oxidation of terminal electrodes and deterioration of taping/packaging materials may take place.</p>