

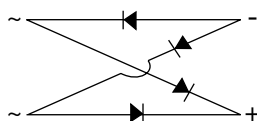

Low Profile Miniature Glass Passivated Single-Phase Surface Mount Bridge Rectifiers

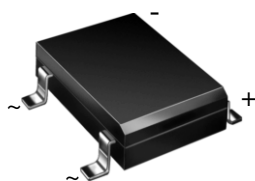

Case Style Low Pro le DFS

FEATURES

- Low profile: typical height of 2.5 mm
- UL recognition, file number E54214
- Ideal for automated placement
- High surge current capability
- Meets MSL level 1, per J-STD-020, LF maximum peak of 250 °C
- Solder dip 260 °C, 40 s
- Compliant to RoHS directive 2002/95/EC and in accordance to WEEE 2002/96/EC

RoHS
COMPLIANT

TYPICAL APPLICATIONS

General purpose use in ac-to-dc bridge full wave rectification for SMPS, lighting ballaster, adapter, battery charger, home appliances, office equipment, and telecommunication applications.

MECHANICAL DATA

Case: Low profile DFS

Epoxy meets UL 94 V-0 flammability rating

Terminals: Matte tin plated leads, solderable per J-STD-002 and JESD22-B102

E3 suffix for consumer grade, meets JESD 201 class 1A whisker test

Polarity: As marked on body

PRIMARY CHARACTERISTICS	
$I_{F(AV)}$	1.5 A
V_{RRM}	50 V to 1000 V
I_{FSM}	50 A
I_R	5 μ A
V_F	1.1 V
T_J max.	150 °C

MAXIMUM RATINGS ($T_A = 25$ °C unless otherwise noted)									
PARAMETER	SYMBOL	DFL 15005S	DFL 1501S	DFL 1502S	DFL 1504S	DFL 1506S	DFL 1508S	DFL 1510S	UNIT
Maximum repetitive peak reverse voltage	V_{RRM}	50	100	200	400	600	800	1000	V
Maximum RMS voltage	V_{RMS}	35	70	140	280	420	560	700	V
Maximum DC blocking voltage	V_{DC}	50	100	200	400	600	800	1000	V
Maximum average forward output rectified current at $T_A = 40$ °C	$I_{F(AV)}$ ⁽¹⁾	1.5							A
Peak forward surge current single half sine-wave superimposed on rated load	I_{FSM}	50							A
Rating for fusing ($t < 8.3$ ms)	I^2t	10							A ² s
Operating junction and storage temperature range	T_J, T_{STG}	- 55 to + 150							°C

Note

⁽¹⁾ Units mounted on P.C.B. with 0.51" x 0.51" (13 mm x 13 mm) copper pads

DFL15005S thru DFL1510S

Vishay General Semiconductor



ELECTRICAL CHARACTERISTICS (T _A = 25 °C unless otherwise noted)											
PARAMETER	TEST CONDITIONS	SYMBOL	DFL 15005S	DFL 1501S	DFL 1502S	DFL 1504S	DFL 1506S	DFL 1508S	DFL 1510S	UNIT	
Max. instantaneous forward voltage drop per diode	1.5 A	V _F	1.1								V
Maximum DC reverse current at rated DC blocking voltage per diode	T _A = 25 °C	I _R	5.0								μA
	T _A = 125 °C		500								
Typical junction capacitance per diode		C _J ⁽¹⁾	16								pF

Note

⁽¹⁾ Measured at 1.0 MHz and applied reverse voltage of 4.0 V

THERMAL CHARACTERISTICS (T _A = 25 °C unless otherwise noted)										
PARAMETER	SYMBOL	DFL 15005S	DFL 1501S	DFL 1502S	DFL 1504S	DFL 1506S	DFL 1508S	DFL 1510S	UNIT	
Typical thermal resistance	R _{θJA} ⁽¹⁾	40								°C/W
	R _{θJL} ⁽¹⁾	15								

Note

⁽¹⁾ Units mounted on P.C.B. with 0.51" x 0.51" (13 mm x 13 mm) copper pads

ORDERING INFORMATION (Example)				
PREFERRED P/N	UNIT WEIGHT (g)	PREFERRED PACKAGE CODE	BASE QUANTITY	DELIVERY MODE
DFL1506S-E3/45	0.341	45	50	Tube
DFL1506S-E3/77	0.341	77	1500	13" diameter paper tape and reel

RATINGS AND CHARACTERISTICS CURVES

(T_A = 25 °C unless otherwise noted)

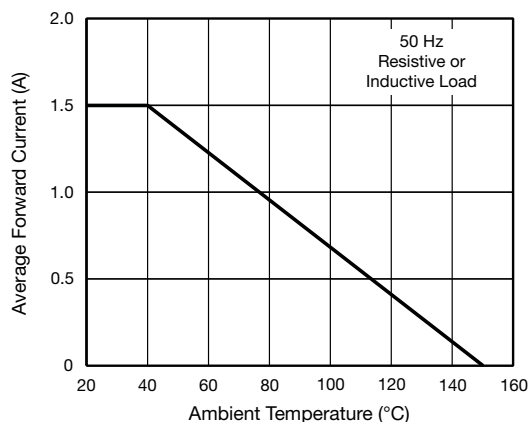

Fig. 1 - Forward Current Derating Curve Per Diode

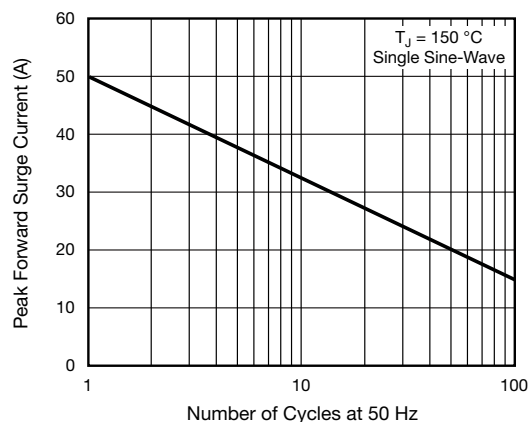

Fig. 2 - Maximum Non-Repetitive Peak Forward Surge Current Per Diode



DFL15005S thru DFL1510S

Vishay General Semiconductor

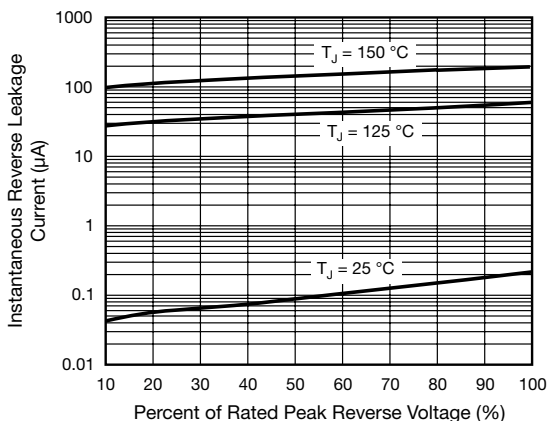
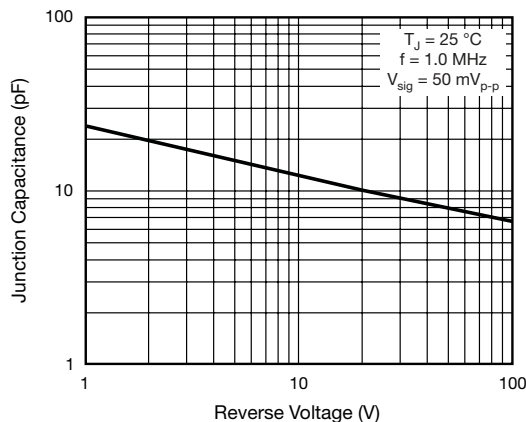
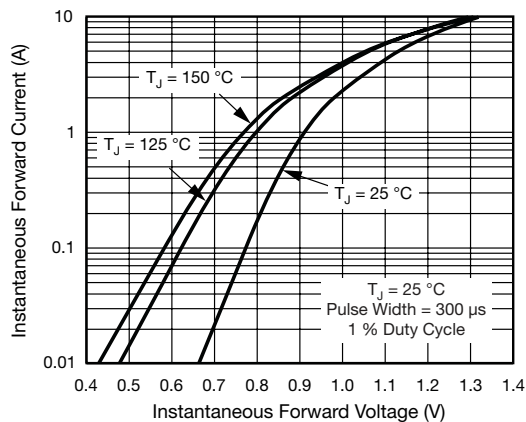

Fig. 3 - Typical Forward Voltage Characteristics Per Diode

Fig. 5 - Typical Junction Capacitance Per Diode

Fig. 4 - Typical Reverse Characteristics Per Diode

PACKAGE OUTLINE DIMENSIONS in inches (millimeters)

Case Style Low Profile DFS

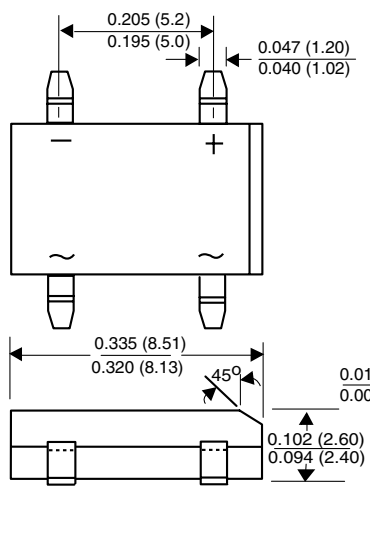

Mounting Pad Layout

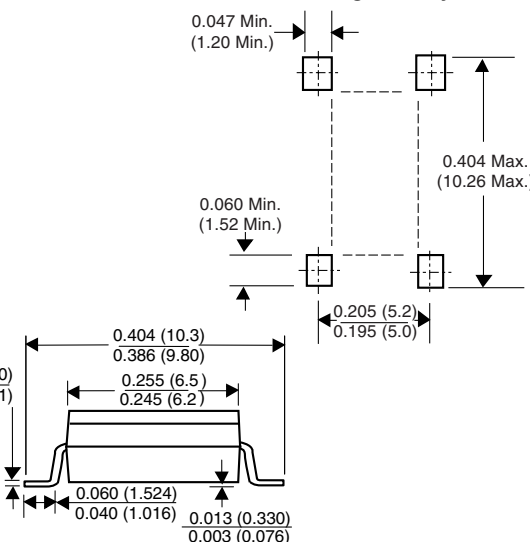



Disclaimer

All product specifications and data are subject to change without notice.

Vishay Intertechnology, Inc., its affiliates, agents, and employees, and all persons acting on its or their behalf (collectively, "Vishay"), disclaim any and all liability for any errors, inaccuracies or incompleteness contained herein or in any other disclosure relating to any product.

Vishay disclaims any and all liability arising out of the use or application of any product described herein or of any information provided herein to the maximum extent permitted by law. The product specifications do not expand or otherwise modify Vishay's terms and conditions of purchase, including but not limited to the warranty expressed therein, which apply to these products.

No license, express or implied, by estoppel or otherwise, to any intellectual property rights is granted by this document or by any conduct of Vishay.

The products shown herein are not designed for use in medical, life-saving, or life-sustaining applications unless otherwise expressly indicated. Customers using or selling Vishay products not expressly indicated for use in such applications do so entirely at their own risk and agree to fully indemnify Vishay for any damages arising or resulting from such use or sale. Please contact authorized Vishay personnel to obtain written terms and conditions regarding products designed for such applications.

Product names and markings noted herein may be trademarks of their respective owners.