

DIP Rotaries

FR02 10mm Ultra-Thin SMT

New Shaft Actuator Option

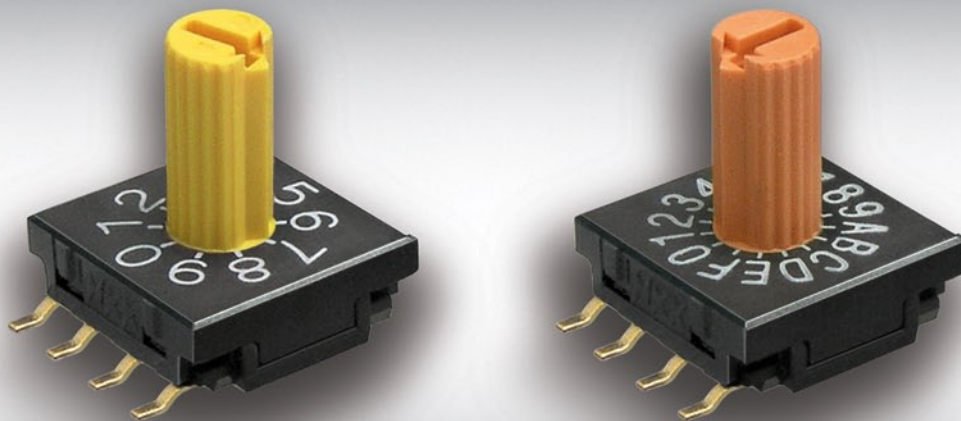

NIKK
SWITCHES

General Specifications

Electrical Capacity (Resistive Load)

Switching Rating:	100mA @ 5V DC
Nonswitching Rating:	100mA @ 50V DC

Other Ratings

Contact Resistance:	100 milliohms maximum for circuit; 30 milliohms maximum for contact point
Insulation Resistance:	1,000 megohms minimum @ 250V DC
Dielectric Strength:	250V AC minimum for 1 minute minimum
Mechanical Life:	10,000 detent operations minimum
Electrical Life:	10,000 detent operations minimum

Notes: A detent operation is one actuator position operation or stepping.
A cycle is one 360° rotation. 10,000 detent operations equal
625 cycles for hexadecimal devices or 1,000 cycles for decimal devices.

Nominal Operating Torque:	0.008Nm for decimal devices; 0.01Nm for hexadecimal devices
Contact Timing:	Nonshorting

Materials & Finishes

Actuators:	Screwdriver and Plastic Shaft - Glass fiber reinforced polyamide (UL94V-0)
Housing & Base:	Glass fiber reinforced polyamide (UL94V-0)
Leaf Spring:	Stainless steel
Movable Contacts:	Copper alloy with gold plating
Stationary Contacts:	Phosphor bronze with gold plating
Terminals:	Phosphor bronze with gold plating

Environmental Data

Operating Temperature Range:	-25°C through +85°C (-13°F through +185°F)
Humidity:	90 ~ 95% humidity for 240 hours @ 40°C (104°F)
Vibration:	10 ~ 55Hz with peak-to-peak amplitude of 1.5mm traversing the frequency range & returning in 5 minutes; 3 right angled directions for 2 hours
Shock:	50G (490m/s ²) acceleration (tested in 6 right angled directions, with 5 shocks in each direction)

Processing

Soldering:	See last page.
Cleaning:	See last page.

Standards & Certifications

Flammability Standards:	UL94V-0 rated actuator, housing, & base The FR02 Series rotaries have not been tested for UL recognition or CSA certification. These switches are designed for use in a low-voltage, low-current circuit. When used as intended, the results do not produce hazardous energy.
--------------------------------	--

Distinctive Characteristics

Slim .150" (3.8mm) body has the lowest profile in the industry and allows close stacking of PC boards.

Highly visible legends and choice of screwdriver or shaft actuators with arrow position indication provide trouble-free code setting.

Detent mechanism gives crisp, positive action for accurate switch setting.

Use of heat resistant resin allows infrared convection reflow soldering.

Gull-winged terminals ensure mechanical stability during soldering and simplify solder joint inspection.

Cam activated movable contact and gold contacts assure contact reliability and continuity.

Tape-reel packaging meets EIA-481-2 Standard.

Coplanarity: all considered surfaces must lie between two parallel planes that are a maximum distance apart of .0059" (0.15mm).

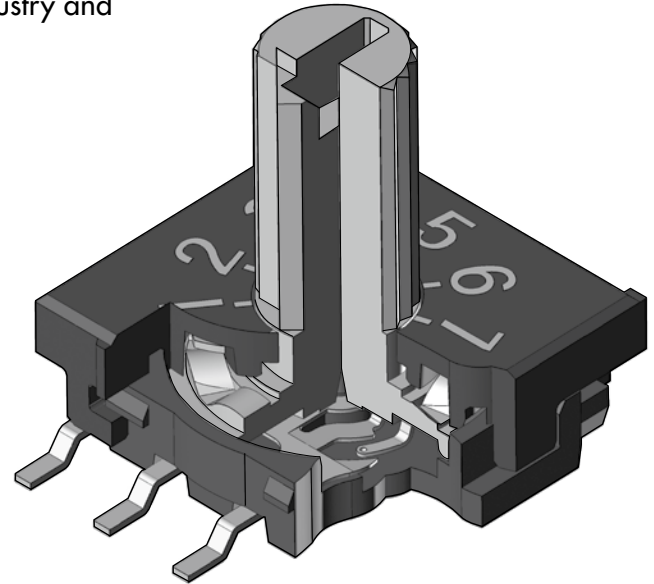

Actual Size

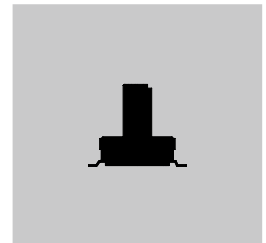

TRUTH TABLES (CIRCUITS & POSITIONS)

Terminal No. (Output)	Actuator Position ● = ON	10 Decimal										16 Hexadecimal															
		0	1	2	3	4	5	6	7	8	9	0	1	2	3	4	5	6	7	8	9	A	B	C	D	E	F
R Real Coded Model Numbers: FR02FR, FR02KR	1		●		●		●		●		●		●		●		●		●		●		●		●		●
	2			●	●			●	●				●	●			●	●				●	●			●	●
	4					●	●	●	●					●	●	●	●					●	●	●	●		
	8								●	●									●	●	●	●	●	●	●	●	●
C Complement Coded Model Numbers: FR02FC, FR02KC	1	●		●		●		●		●		●		●		●		●		●		●		●		●	
	2	●	●			●	●			●	●			●	●			●	●			●	●			●	●
	4	●	●	●	●					●	●	●	●					●	●	●	●				●	●	●
	8	●	●	●	●	●	●	●						●	●	●	●	●	●							●	●

Terminal numbers are actually on the switch.

TYPICAL SWITCH ORDERING EXAMPLE

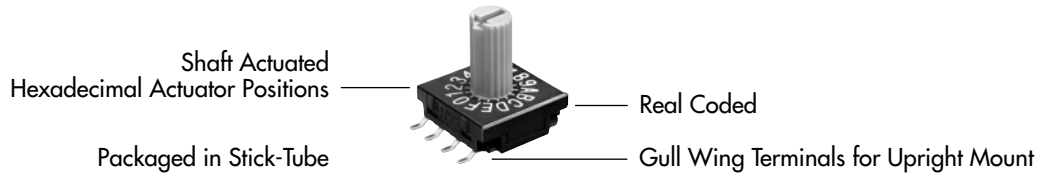
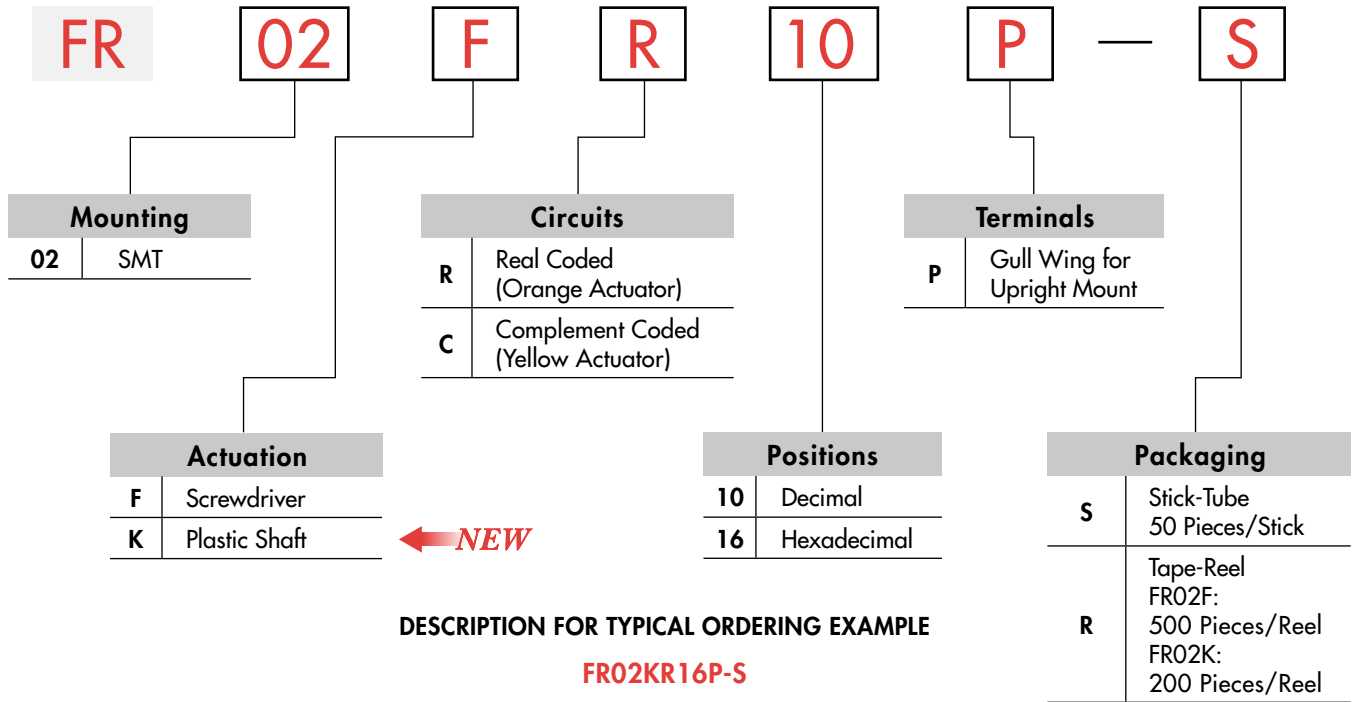

ACTUATION

F Screwdriver
Adjusted with a flat tipped screwdriver

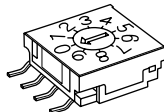

K Plastic Shaft **← NEW**
Adjusted by hand or with flat tipped screwdriver

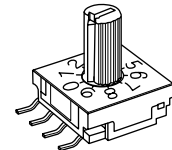

Actuators are fully rotational either clockwise or counterclockwise.
Actuator Colors: Orange for real coded devices; Yellow for complement coded devices.

TYPICAL SWITCH DIMENSIONS

P Upright • Screwdriver



FR02FC10P

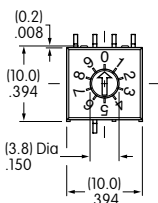

Decimal

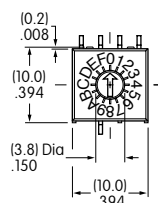

Hexadecimal

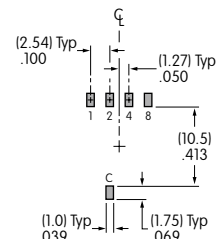
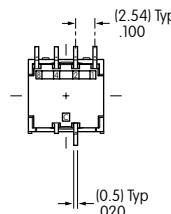
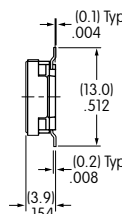

TYPICAL SWITCH DIMENSIONS

Upright • Plastic Shaft

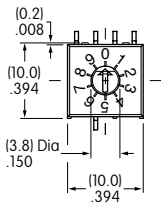

Decimal

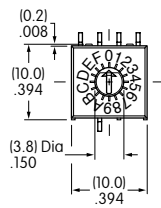

Hexadecimal

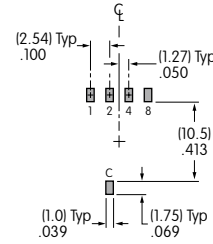
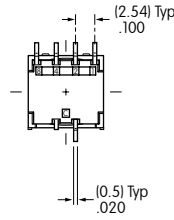
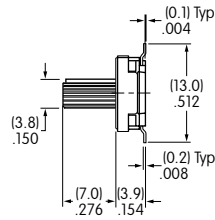

FR02KC16P

PACKAGING



Stick-Tube

FR02F & FR02K

Each stick-tube contains 50 switches.
Switches must be ordered in 50-piece increments.

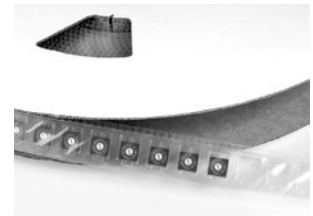
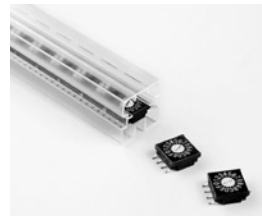
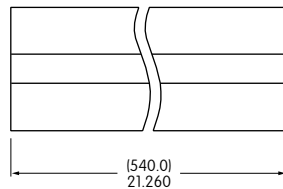
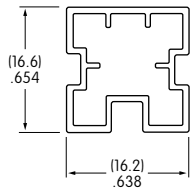

Tape-Reel

FR02F

Switches must be ordered in 500-piece increments.
This packaging meets EIA-481-2 Standard.

Each tape-reel of 550 pockets contains 500 switches.
Minimum Leader Length: 15.748" (400mm)
Minimum Trailer Length: 6.299" (160mm)

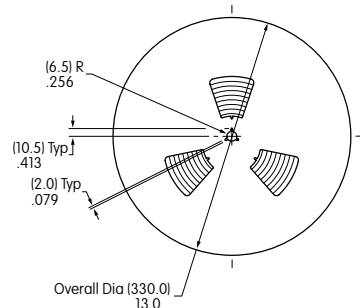

FR02F

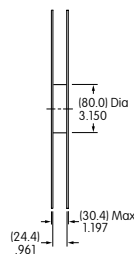

FR02K

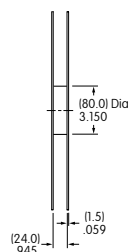

FR02K

Switches must be ordered in 200-piece increments.
This packaging meets EIA-481-2 Standard.

Each tape-reel of 250 pockets contains 200 switches.
Minimum Leader Length: 15.748" (400mm)
Minimum Trailer Length: 6.299" (160mm)

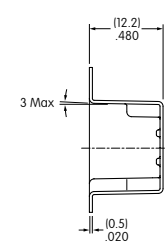
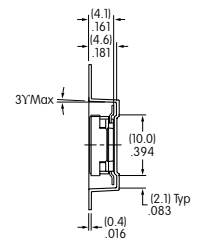
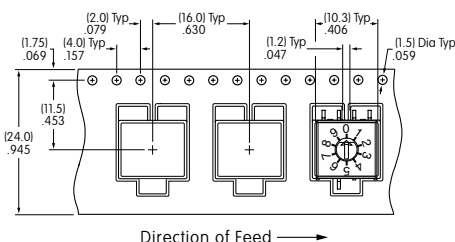
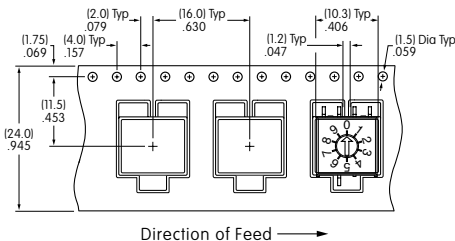

PROCESSING

FR02F & FR02K

Soldering:

Manual Soldering: 390°C soldering iron tip temperature; 4 seconds time on terminal; 2 cycles

Reflow Soldering Recommended. See illustration and table.

Note: During Reflow Soldering process, set the switch to the following position: FR02FR10P, FR02FR16P, FR02KR10P, FR02KR16P: 0 position; FR02FC10P, FR02KC10P: 7 position; FR02FC16P, FR02KC16P: F position

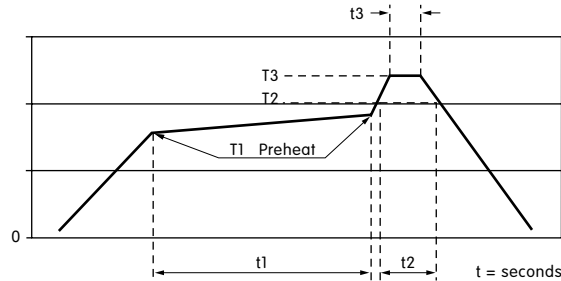

Reflow Solder Profile	Symbol	Profile A High Temperature
Preheat Temperature	T1	180°C ~ 200°C
Preheat Time	t1	120 seconds
Heating Temperature	T2	230°C
Heating Time	t2	60 seconds
Peak Temperature (Surface)	T3	250°C
Peak Time	t3	Not Specified
Thickness of PCB		1.6mm
Cycles		2
Comments		PCB with no Lead

Note: The Reflow Solder profile above describes the printed circuit board (PCB) surface temperature. Since PCB surface temperature and switch surface temperature will vary depending on the height of switch, PCB material, and PCB thickness, ensure switch surface temperature does not exceed 250°C. Contact factory if your conditions are more severe than above specifications.

Cleaning:

These devices are not process sealed. Hand clean locally using alcohol based solution to remove flux on surface of PCB.

Handling:

When installing, avoid putting mechanical stress on terminal area.



www.nkkswitches.com

Phone 480.991.0942 • Toll Free 877.228.9655
7850 East Gelding Drive • Scottsdale, Arizona 85260