

Handtools

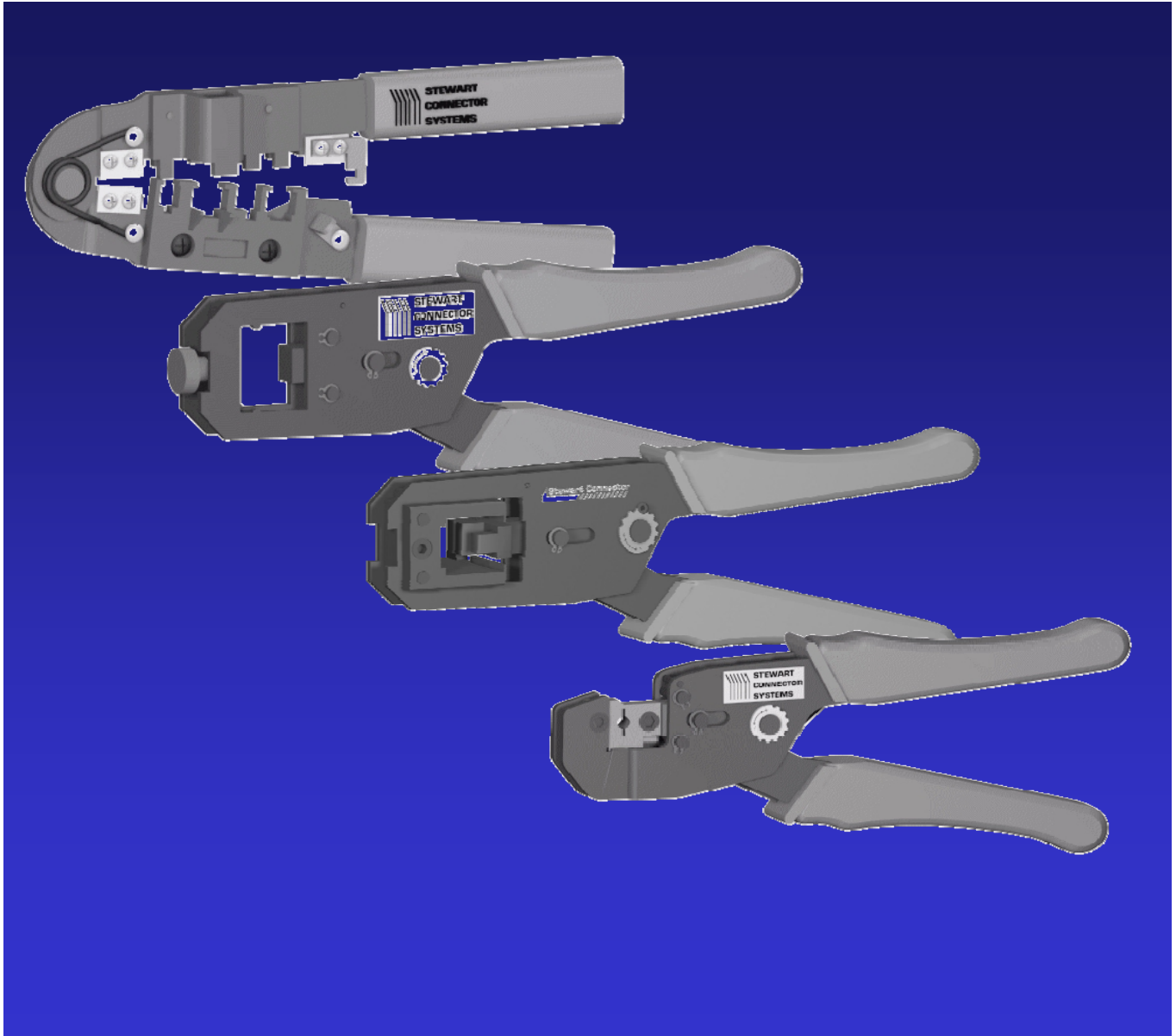

Tooling

multi-functional hand tools

Platens:

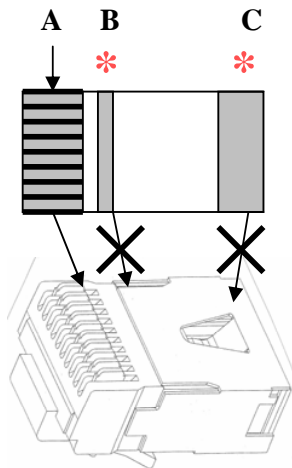

*combi die set 2980021-01 accepts ferrule inserts, order ferrule inserts separately to suit cable O/D
(e.g. 2980035-01 for 6mm O/D cable)

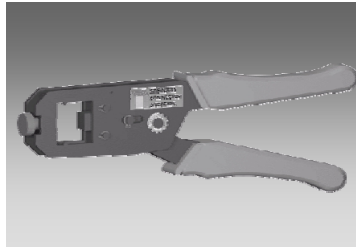

2980019-01-B

Professional handtool for use with hardened die sets. The combi die set for shielded plugs also accepts ferrule crimping dies. For the longterm and large cable assembly.



Suitable dies for tool 2980019-01:

No. of contacts	part-no.	Die platens loaded in die sets		
		A	B	C
4 UTP	2980024-01	○	○	○
6UTP	2980026-01	○	○	○
6 UTP SL Version	2980043-01	○	○	○
6 UTP MMJ	2980025-01	○	○	○
8 UTP	2980036-01	○	○	○
8 UTP Cat 5/6	2980039-01	○		○
8 UTP Cat 6 new	2980047-01	○		
10 UTP	2980038-01	○	○	○
6 STP	2980041-01	○		
8 STP	2980020-01	○		
10 STP	2980037-01	○		

combi die	part-no.	ferrule insert	outer cable-O
8 STP	2980021-01	2980034-01	max. 3,7mm
		2980022-01	max. 4,5mm
		2980023-01	max. 5,2mm
		2980035-01	max. 6,0mm



2980042

Simple table fixture for easier handling.

* Warning !!! Tool Die Platens will be damaged if Unshielded Die Sets are used for Shielded Plugs. The Shielded Plugs only require platen "A", the Cat 5 UTP & the 2PC Plugs only require platens "A" & "C"

Tooling

multi-functional hand tools

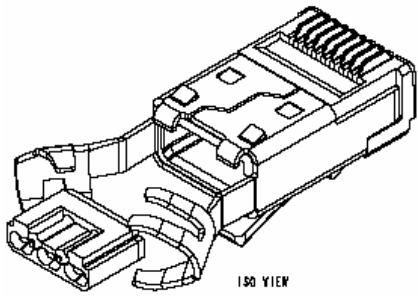
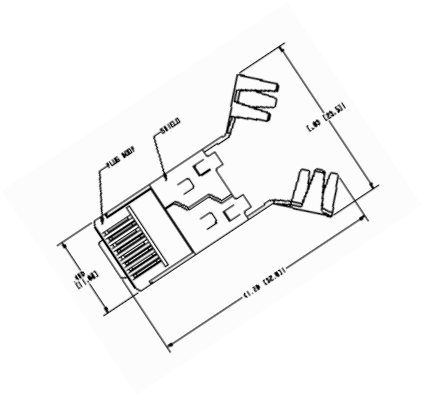

2980070-01 & 2980075-01
 Professional Handtool for the assembly of shielded Cat 6 plugs. This is a real One-Step tool: contacts and shield is crimped at the same time.

Completer handtool and die-set

Plug	Part number	outer cable Ø
SS-39200-010 / 011	2980075-01	more than 6mm
SS-39200-012	2980070-01	less than 6mm

discrete die-set

Ø more than 6mm		Ø less than 6mm	
Part number	die-set	Part number	die-set
2980076-01	discrete	2980071-01	discrete
2980077-01	shield crimp die	2980072-01	shield crimp die

multi-functional hand tools

Tooling

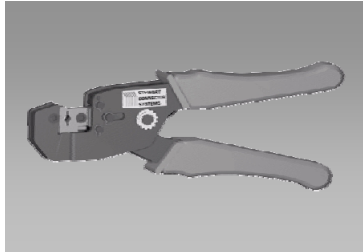

2980028-01-B

Ferrule Handtool for the assembly of shielded SCS plugs (CAT3/CAT5/CAT5+). The ferrule insert can be easily exchanged for the individual cable diameters.

Outer cable-Ø	part-no.
max. 3,7 mm	2980029-01
max. 4,5 mm	2980030-01
max. 5,2 mm	2980031-01
max. 6 mm	2980032-01
max. 6,5 mm	2980065-01

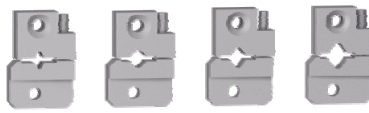

Suitable dies for tool 2980028-01:

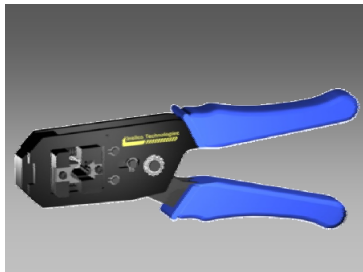
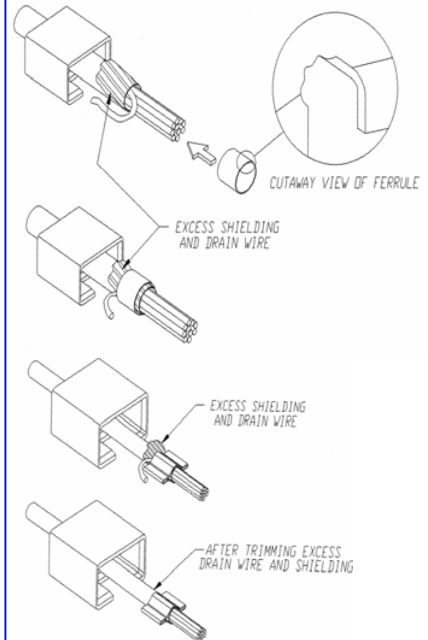

2980050-01 & 2980055-01

Professional Handtool for the assembly of shielded Voice-Series™ plugs (V-P-88-S). This is a real One-Step tool: contacts and shield is crimped at the same time.

Outer shield-Ø	part-no.
max. 5,7 mm	2980050-01
max. 6,4 mm	2980055-01



2940011-01

Wire cutter made of stainless 'Solingen'-steel for cutting wires at the assembly of shielded SCS plugs and Cable jacks.

Tooling

multi-functional hand tools

Die Platens Loaded 2980027-01 & 2980033-01

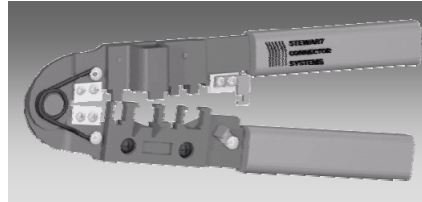
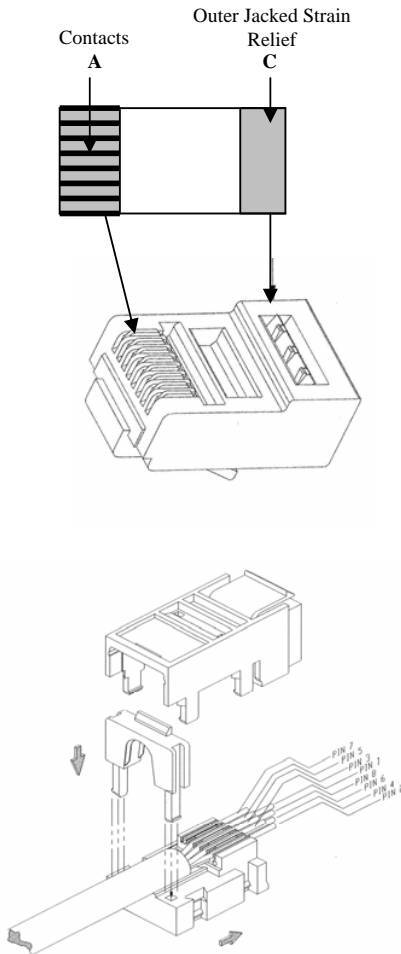

Note:- The above tools do not crimp the inner conductor strain relief situated immediately after the contact blade platen

2980027-01

simple and cheap multi-functional hand tools including stripper and cutter to assemble 4-, 6-, MMJ 6- and 8- pole modular plugs.

2980033-01

same as tool above but with 10-pole instead of 8-pole insert.

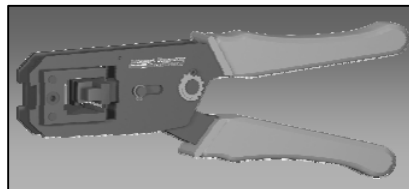

2980040-01

Professional ratched handtool with fixed die set included. For assembly of all Stewart Connector CableJacks.

part-no.

SS-800810-xxx

SS-800810SB-xxx

SS-801010-xxx

SS-801010SB-xxx

Suitable Cable Jacks for tool 2980040-01:

Bench-Mount Press

Tooling



2980100-01

This table mount tool is a low-cost alternative for semi quantity assemblies.

Unique features like:

- adjustable/turnable insert
- adjustable lever force
- ShureStake principle for reliable results
- spring supported lever goes back to start position automatically
- sensitive feedback about final crimp position
- same inserts like for 2980019-01
- all frame parts are made of hardened steel

- 1 year warranty

Inserts for Bench-Mount Press to be used with professional crimping bench-mount-press above

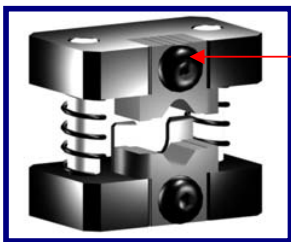

4 different sizes for cable diameters

Easily exchangeable suitable sub-inserts

part-no.	description	marking
2980060-01	main die set	
2980061-01	sub-insert for Ø3,7 mm	I stripe
2980062-01	sub-insert for Ø4,5 mm	II stripe
2980063-01	sub-insert for Ø5,2 mm	III stripe
2980064-01	sub-insert for Ø6,0 mm	IIII stripe

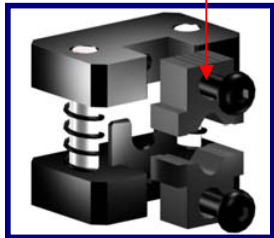

Puch-Down Tool

Tooling

298HT900

Punch-Down Tool for use together with our VoiceSeries PunchDownBlocks (e.g. V-PDB-8). Supplied together with a belt-case.



- The electric Crimp-Press is an extremely versatile crimp machine.
- The ECP1500 is deliverable with and without a tester for conductivity and short circuit.
- It is able to use the standard die sets.
- Fast cycle time allows approx. 800 pieces per hour.
- The connecting cables can be crimped together in one operation with simultaneous test for conductivity and short circuit.
- The crimping cycle including test takes approx. 1,3 sec.

