

Built-in Amplifier Photoelectric Sensor

E3S-C

Water- and Oil-resistive Photoelectric Sensor with Metal Housing Ensuring Long Sensing Distance

- Satisfies the requirements of IP67, NEMA 6P, and IP67G (oil-tight).
- Sensing distance six times as long as OMRON's conventional Photoelectric Sensors ensures stable detection of objects.
- Ensures a vibration resistance of 10 Hz to 2 kHz and a shock resistance of 1,000 m/s² (approximately 100G).
- Incorporating an NPN and PNP output selector, thus reducing the stock of photoelectric sensors.
- Incorporating a fuzzy mutual interference prevention function.
- The E3S-C's optical axis coincides with its mechanical axis, thus ensuring axis adjustment with ease.



Ordering Information

■ E3S-C

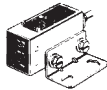
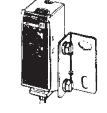
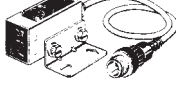
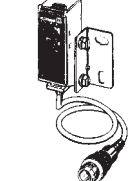
Connections	Appearance	Sensing method	Sensing distance	Operating mode	Model
Prewired	Horizontal 	Through-beam	30 m	Light-ON Dark-ON (selectable)	E3S-CT11
		Retroreflective	3 m (polarized red light source)		E3S-CR11
		Diffuse reflective	70 cm		E3S-CD11
	2 m		E3S-CD12		
	Vertical 	Through-beam	30 m		E3S-CT61
		Retroreflective	3 m (polarized red light source)		E3S-CR61
Diffuse reflective		70 cm	E3S-CD61		
	2 m	E3S-CD62			
Junction connector	Horizontal 	Through-beam	30 m	Light-ON Dark-ON (selectable)	E3S-CT11-M1J
		Retroreflective	3 m (MSR polarized red light source)		E3S-CR11-M1J
		Diffuse reflective	70 cm		E3S-CD11-M1J
	2 m		E3S-CD12-M1J		
	Vertical 	Through-beam	30 m		E3S-CT61-M1J
		Retroreflective	3 m (MSR polarized red light source)		E3S-CR61-M1J
Diffuse reflective		70 cm	E3S-CD61-M1J		
	2 m	E3S-CD62-M1J			



■ Accessories (Order Separately)

For E3S-C

Name	Model	Remarks
Slit for Through-beam Sensor	E39-S61	A set consisting of a 0.5-mm, 1-mm, 2-mm, and 4-mm slits.
Vertical Mounting Bracket for the E3S-□□□□42 or E3S□□□□44 for adjustment of the Photoelectric Sensor's optical axis direction (see note)	E39-L85	Replaces the E3S with the E3S-C Series.
Vertical Mounting Bracket for the E3S-□□□□43 for adjustment of the Photoelectric Sensor's optical axis direction (see note)	E39-L86	
Special Mounting Bracket	E39-L87	

Note: Refer to page 17 for the optical axis direction of each model.

I/O Connector

Appearance	Cord		Model
Single-mold Connector on one end only 	2 m	3-wired	XS2F-D421-DC0-A
	5 m	3-wired	XS2F-D421-GC0-A
Single-mold Connector on each end 	2 m	4-wired	XS2W-D421-D81-A
	5 m	4-wired	XS2W-D421-G81-A
Connector Junction Box 	5 m	4-point input (NPN)	XW3A-P445-G11
		4-point input (PNP)	XW3A-P443-G11

Specifications

Prewired Models

Item	Through-beam	Retroreflective	Diffuse reflective	
	E3S-CT11 E3S-CT61	E3S-CR11 E3S-CR61	E3S-CD11 E3S-CD61	E3S-CD12 E3S-CD62
LED for emitter	Infrared LED (880 nm)	Red LED (700 nm)	Infrared LED (880 nm)	
Sensitivity adjustment	One-turn adjustor		Two-turn endless adjustor with an indicator	
Connection method	Prewired			
Weight	Horizontal model: 110 g (with 2-mm cord) Vertical model: 115 g (with 2-mm cord)			
Output configuration	NPN or PNP (selectable) open collector current output			
Control output	Light ON or Dark ON (selectable)			
Circuit protection	Load short-circuit protection, reversed connection protection, and mutual interference prevention function (except for through-beam models)			
Indicator	Emitter: Emission indicator (red) Receiver: Stability indicator (green), light indicator (red)	Stability indicator (green), light indicator (red)		
Materials	Case: Zinc die-cast Operation panel: Sulfonated polyether Lens: Acrylic Mounting bracket: Stainless			
Attachments	Mounting bracket, screw driver for adjustment, M4 hexagonal bolts, instruction sheet, and reflector (E39-R1: retroreflective model only)			

Junction Connector Models

Item	Through-beam	Retroreflective	Diffuse reflective	
	E3S-CT11-M1J E3S-CT61-M1J	E3S-CR11-M1J E3S-CR61-M1J	E3S-CD11-M1J E3S-CD61-M1J	E3S-CD12-M1J E3S-CD62-M1J
LED for emitter	Infrared LED (880 nm)	Red LED (700 nm)	Infrared LED (880 nm)	
Sensitivity adjustment	One-turn adjustor		Two-turn endless adjustor with an indicator	
Connection method	M12 metal junction connector (cord length: 30 cm)			
Weight	Approx. 80 g (with 30-cm cord and connector)			
Output configuration	NPN or PNP (selectable) open collector current output			
Control output	Light ON or Dark ON (selectable)			
Circuit protection	Load short-circuit protection, reversed connection protection, and mutual interference prevention function (except for through-beam models)			
Indicator	Emitter: Emission indicator (red) Receiver: Stability indicator (green), light indicator (red)	Stability indicator (green), light indicator (red)		
Materials	Case: Zinc die-cast Operation panel: Sulfonated polyether Lens: Acrylic Mounting bracket: Stainless			
Attachments	Mounting bracket, screw driver for adjustment, M4 hexagonal bolts, instruction sheet, and reflector (E39-R1: retroreflective model only)			

■ Ratings/Characteristics

Item	Through-beam	Retroreflective	Diffuse reflective	
	E3S-CT11(-M1J) E3S-CT61(-M1J)	E3S-CR11(-M1J) E3S-CR61(-M1J)	E3S-CD11(-M1J) E3S-CD61(-M1J)	E3S-CD12(-M1J) E3S-CD62(-M1J)
Power supply voltage	10 to 30 VDC (including ripple (p-p) 10%)			
Current consumption	50 mA max. (emitter and receiver)	40 mA max.		
Sensing distance (white paper)	0 to 30 m	0 to 3 m	0 to 70 cm	0 to 2 m
Standard sensing object	---	With the E39-R1	30 x 30 cm (white paper)	
Directional angle	3° to 15°	Sensor: 3° to 10° Reflector: 30° min.	---	
Variation in sensing distance	---		±10% max.	
Hysteresis	---		20% max. of sensing distance	
Sensing distance with attachment	4-mm slit: 15 m 2-mm slit: 7 m 1-mm slit: 3.5 m 0.5-mm slit: 1.8 m	E39-R2: 0 to 4 m E39-R3: 0 to 150 cm E39-R4: 0 to 75 cm E39-RSA: 5 to 35 cm E39-RSB: 5 to 60 cm	---	
Min. sensing object (see note)	4-mm slit: 2.6-mm dia. 2-mm slit: 2-mm dia. 1-mm slit: 1-mm dia. 0.5-mm slit: 0.5-mm dia.	E39-R1 Reflector: 13-mm dia. E39-R3: 8-mm dia. E39-R4: 4-mm dia.	---	
Difference in direction between optical axis and mounting direction	±2° max. (checked along extended line in the mounting direction)		±2° max.	
Response time	1 ms max. for both operation and release			2 ms max. for both operation and release
Control output	30 VDC, 100 mA max. (residual voltage: NPN output: 1.2 V max., PNP output: 2.0 V max.), open collector (NPN/PNP output selectable)			
Ambient illumination	Incandescent lamp: illumination on optical spot: 5,000 lx max. Sunlight: illumination on optical spot: 10,000 lx max.			
Ambient temperature	Operating: -25°C to 55°C (with no icing)			
Ambient humidity	Operating: 35% to 85%			
Insulation resistance	20 MΩ min. (at 500 VDC)			
Dielectric strength	1,000 VAC, 50/60 Hz for 1 min			
Vibration resistance	Destruction: 10 to 2,000 Hz, 1.5-mm double amplitude, or 300 m/s ² (approx. 30G) 0.5 hrs each in X, Y, and Z directions			
Shock resistance	Destruction: 1,000 m/s ² (approx. 100G) 3 times each in X, Y, and Z directions			
Enclosure ratings	IEC: IP67, NEMA*: 6P (indoors only), JEM**: IP67G			

*NEMA: National Electrical Manufacturers Association

**JEM: Japan Electrical Manufacturers

Note: At the rated sensing distance, set a sensing object at half the rated sensing distance.

Engineering Data

Parallel Operating Range (Typical)

E3S-CT□1

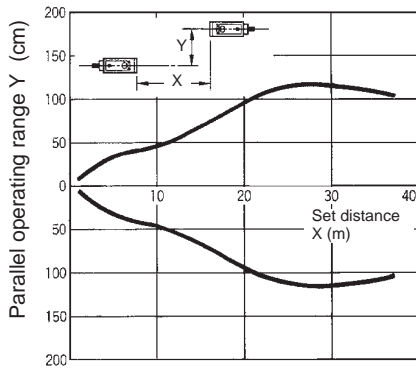

Operating Range (Typical)

E3S-CD□1 (Left and Right)

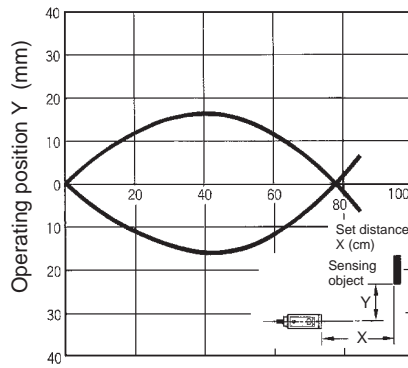

E3S-CD□2 (Left and Right)

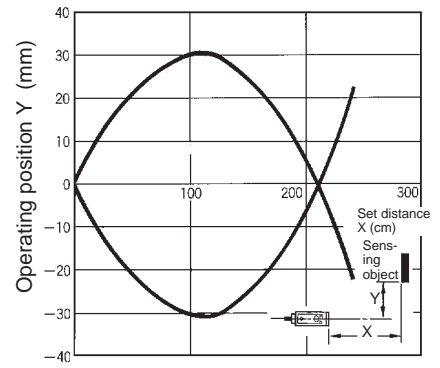

E3S-CD□1 (Up and Down)

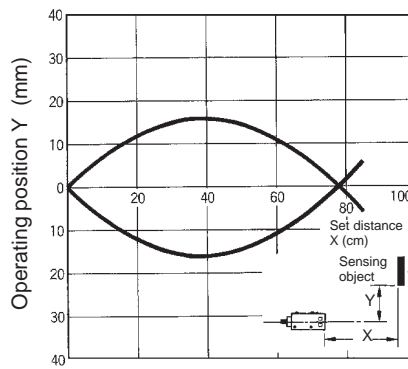

E3S-CD□2 (Up and Down)

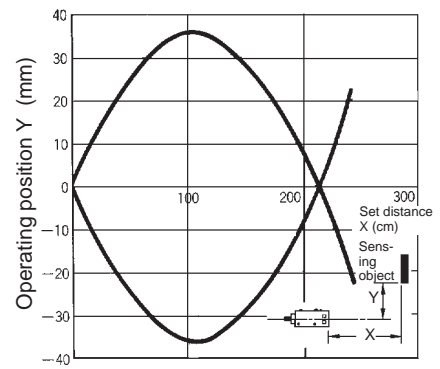

Sensing Distance vs. Object Size (Typical)

E3S-CD□1

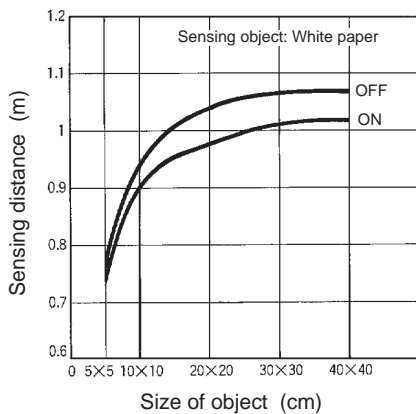

E3S-CD□2

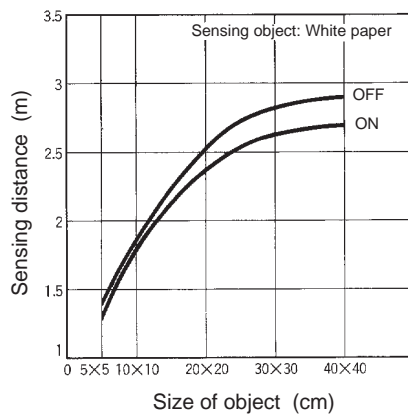

Reflector Parallel Movement (Typical)

E3S-CR□1

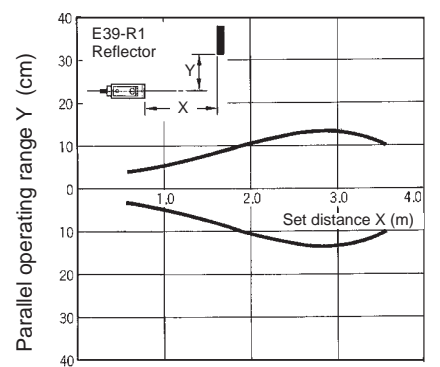

Excess Gain vs. Set Distance (Typical)

E3S-CT□1

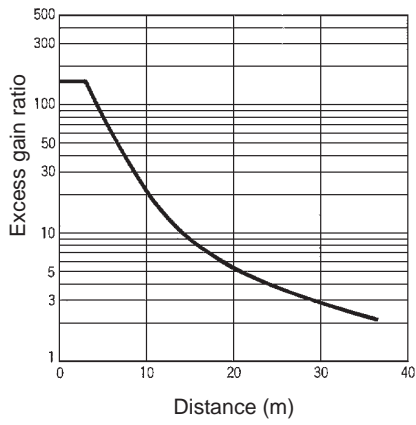

E3S-CR□1 (E39-R1 Reflector)

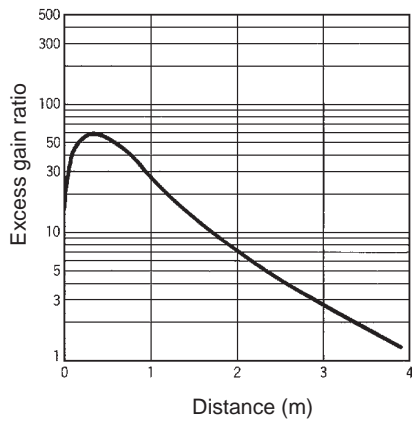

E3S-CD□1

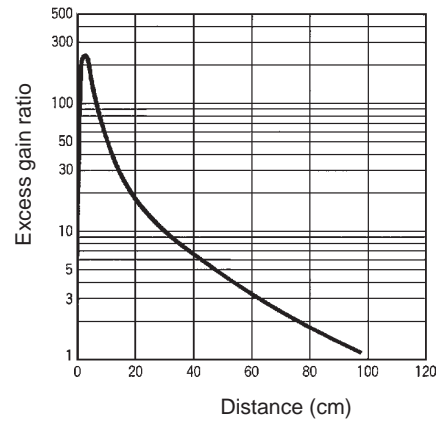

E3S-CD□2

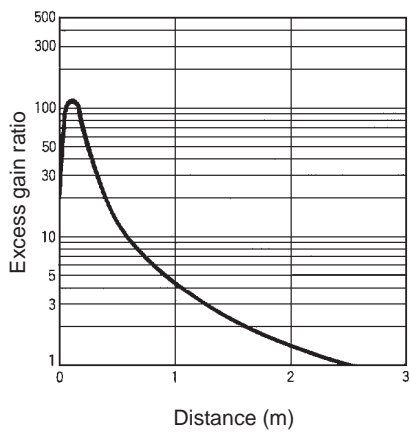

Nomenclature

Horizontal Model

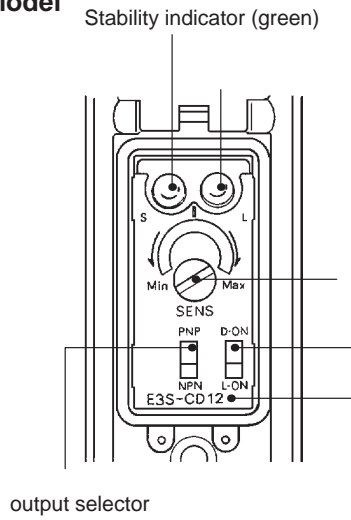

Vertical Model

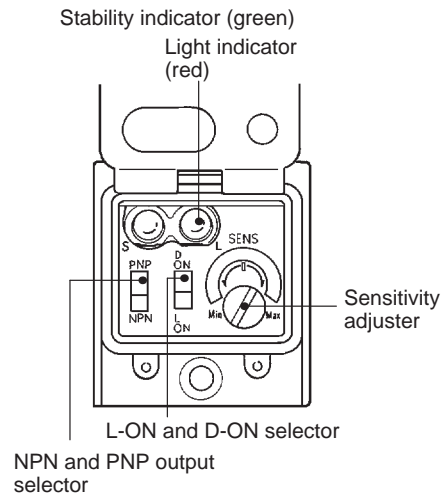

Operation Panel

Use the NPN and PNP output selector on the operation panel to select the type of output transistor.

Use the Light ON and Dark ON selector on the operation panel to select the operation mode of the E3S-C.

Operation

■ Output Circuits

Prewired Models

Output configuration	Mode switch	Output transistor	Output circuits
NPN	Light ON	On when light is received.	
	Dark ON	ON when light is not received.	
PNP	Light ON	On when light is received.	
	Dark ON	ON when light is not received.	

Junction Connector Models

Output configuration	Mode switch	Output transistor	Output circuits
NPN	Light ON	On when light is received.	<p>Reflective Type and Receiver</p> <p>ZD : $V_Z = 39\text{ V}$ Note: Set the NPN and PNP output selector to NPN.</p> <p>Emitter</p> <p>Connector Pin Arrangement</p>
	Dark ON	ON when light is not received.	
PNP	Light ON	On when light is received.	<p>Reflective Type and Receiver</p> <p>ZD : $V_Z = 39\text{ V}$ Note: Set the NPN and PNP output selector to PNP.</p> <p>Emitter</p> <p>Connector Pin Arrangement</p>
	Dark ON	ON when light is not received.	

I/O Connector Plug

NPN Output

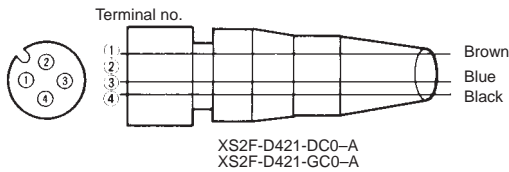



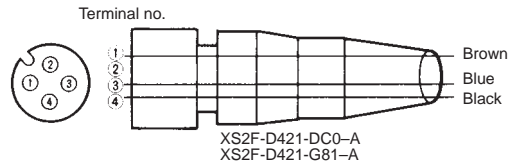









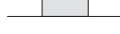

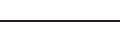





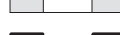









PNP Output

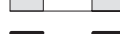
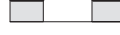

NPN output				PNP output			
Type	Conductor	Connector pin	Application	Type	Conductor	Connector pin	Application
DC	Brown	1	Power supply (+V)	DC	Brown	1	Power supply (+V)
	Black	4	Output		Black	4	Output
	Blue	3	Power supply (0 V)		Blue	3	Power supply (0 V)

■ Timing Chart

Prewired

Output configuration	Mode switch	Output transistor	Timing chart
NPN	Light ON	On when light is received.	Light received  Light not received  Light indicator (Red) ON  OFF  Output transistor ON  OFF  Load (relay) Operate  Release  (Between brown and black)
	Dark ON	ON when light is not received.	Light received  Light not received  Light indicator (Red) ON  OFF  Output transistor ON  OFF  Load (relay) Operate  Release  (Between brown and black)
PNP	Light ON	On when light is received.	Light received  Light not received  Light indicator (Red) ON  OFF  Output transistor ON  OFF  Load (relay) Operate  Release  (Between blue and black)
	Dark ON	ON when light is not received.	Light received  Light not received  Light indicator (Red) ON  OFF  Output transistor ON  OFF  Load (relay) Operate  Release  (Between blue and black)

■ Fuzzy Mutual Interference Prevention Function

If reflective Photoelectric Sensors are installed side by side, each reflective Photoelectric Sensor may be influenced by the light emitted from the other Photoelectric Sensors.

The fuzzy mutual interference prevention function of the E3S-C enables the E3S-C to monitor any light interference for a certain period before the E3S-C starts emitting light so that the E3S-C can retrieve the intensity and frequency of the light interference as data. Using this data, the E3S-C estimates with fuzzy inference the risk of the malfunctioning of the E3S-C and controls the timing of the E3S-C's light emission.

When the risk is low:

The E3S-C waits until there is no light interference and emits light.



When the risk is high:

The E3S-C emits light between each light interference moment.

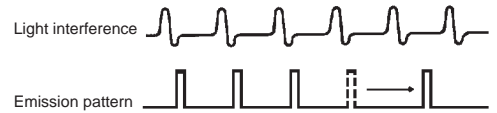

■ Sensitivity Adjustment (Reflective Sensors)

Item	Position A	Position B	Setting
Sensing condition			---
Sensitivity adjustor			
Indicators	OFF <input type="radio"/> STABILITY (green) <input checked="" type="radio"/> ON <input checked="" type="radio"/> LIGHT (red) <input checked="" type="radio"/>	OFF <input type="radio"/> STABILITY (green) <input type="radio"/> OFF <input type="radio"/> LIGHT (red) <input type="radio"/>	OFF <input checked="" type="radio"/> STABILITY (green) <input type="radio"/> ON <input type="radio"/> LIGHT (red) <input type="radio"/>
Procedure	Locate a sensing object at the sensing distance, set the sensitivity adjustor to the minimum scale position, and gradually increase sensitivity by turning the sensitivity adjustor clockwise until the incident light indicator (red LED) is ON. Position A is where the indicator has turned ON. Regard the maximum scale position as Position A if the indicator does not turned ON at full sensitivity.	Remove the sensing object and turn the sensitivity adjustor clockwise until the E3S-C detects the background object and the incident light indicator (red LED) is lit. The moment the red light indicator is lit, stop turning the sensitivity adjustor, the position of which is point B. Turn the sensitivity adjustor counterclockwise to decrease the sensitivity until the red light indicator is OFF, stop turning the sensitivity adjustor, the position of which is point C. If there is no background object, point C is where the sensitivity adjustor is set to maximum.	Set the sensitivity indicator to the position between Positions A and C (in some cases, Positions A and C are opposite of the above example). The photoelectric sensor will then work normally if the stability indicator (green) is lit with and without the sensing object. If it is not lit, stable operation cannot be expected, in which case a different sensing method must be applied.

Unlike conventional photoelectric sensors, the variation in the sensitivity of E3S photoelectric sensors is minimal. This means the sensitivity can be adjusted on only a single photoelectric sensor, and then the adjustors on the other photoelectric sensors can be set to the same scale position. There is no need to adjust the sensitivity of each photoelectric sensor individually.

Dimensions

Note: All units are in millimeters unless otherwise indicated.

E3S-C

E3S-CT11 (Receiver)

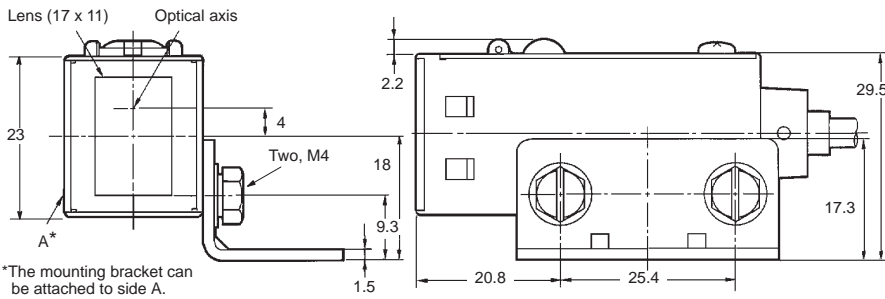
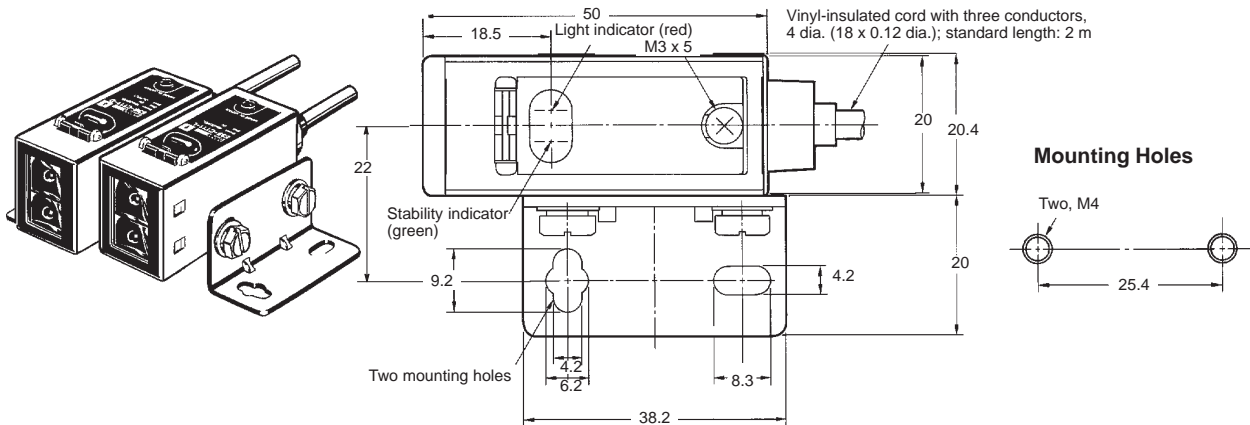

E3S-CT11 (Emitter)

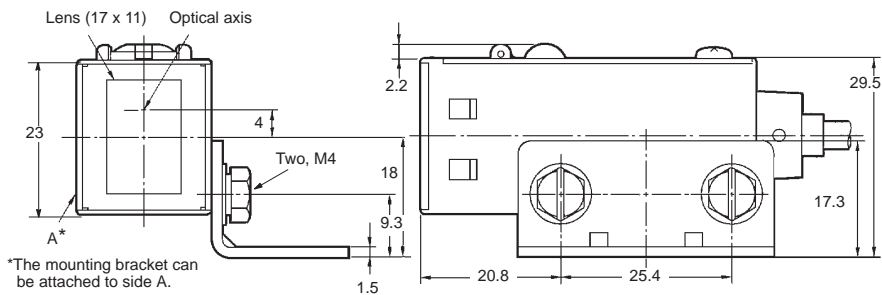
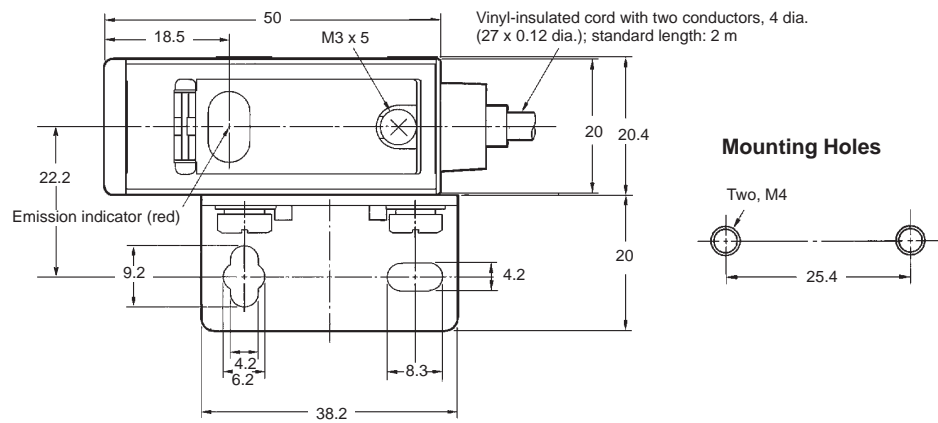

E3S-CR11
E3S-CD11
E3S-CD12

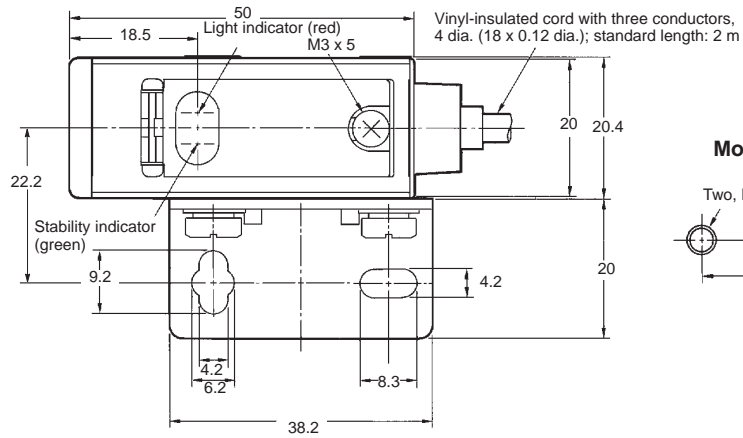
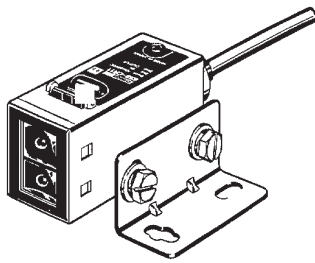

Mounting Holes

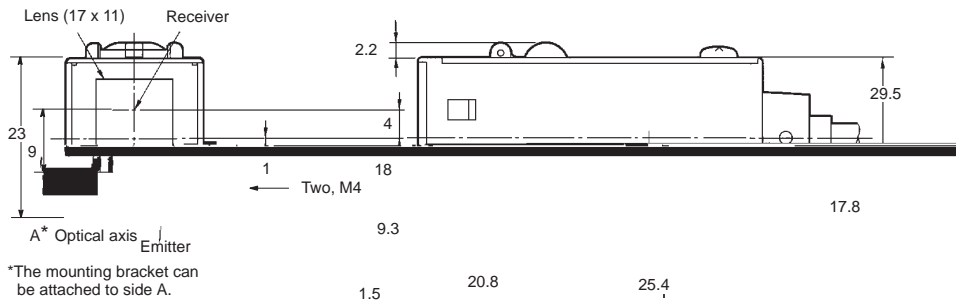
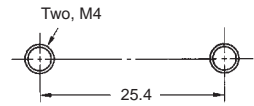

E3S-CT61 (Receiver)

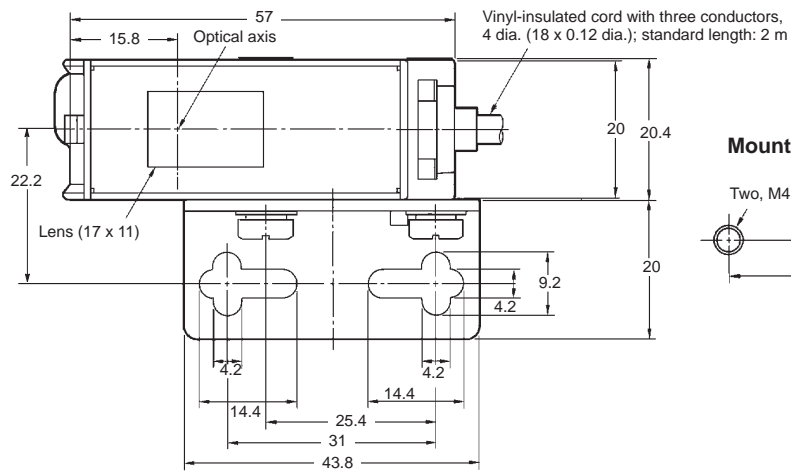
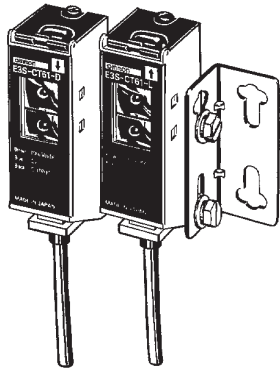

Mounting Holes

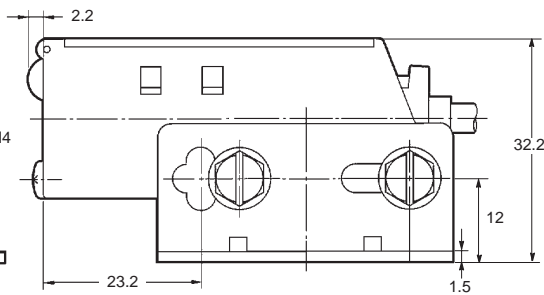
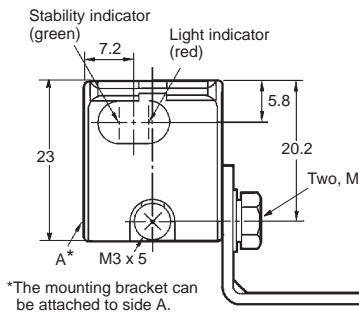
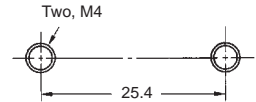

E3S-CT61 (Emitter)

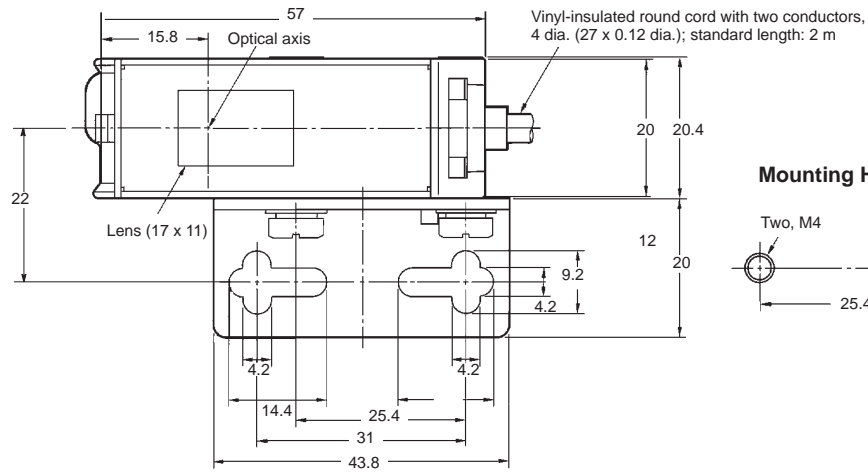

Mounting Holes

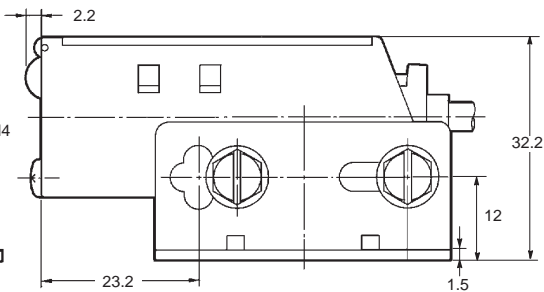
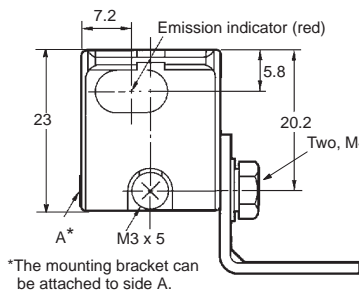
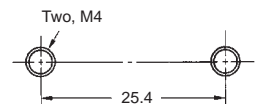

**E3S-CR61
E3S-CD61
E3S-CD62**

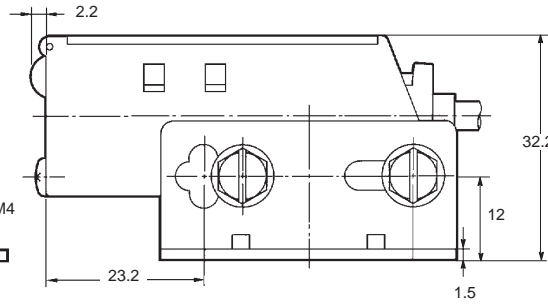
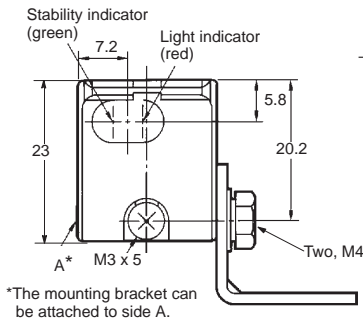
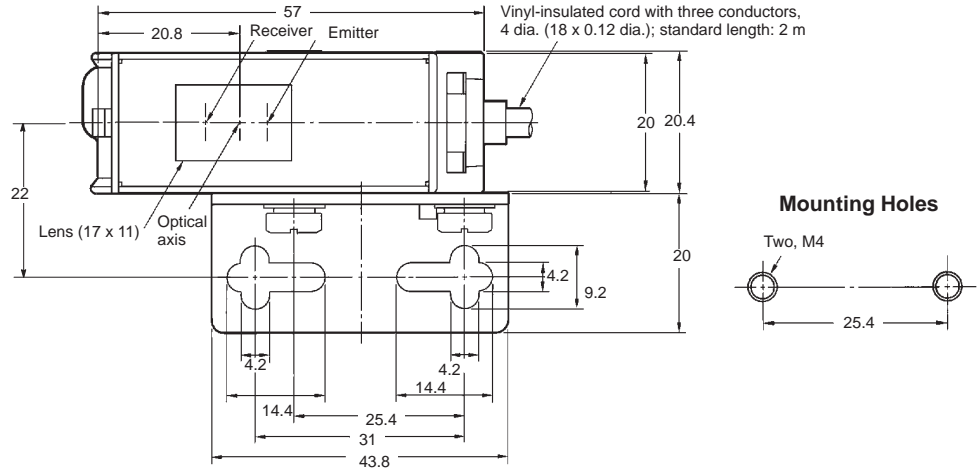
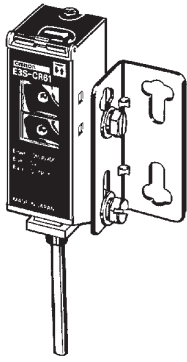

**E3S-C□1□-M1J
(Horizontal)**

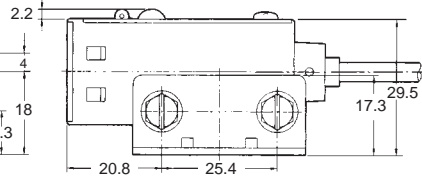
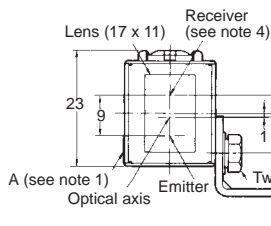
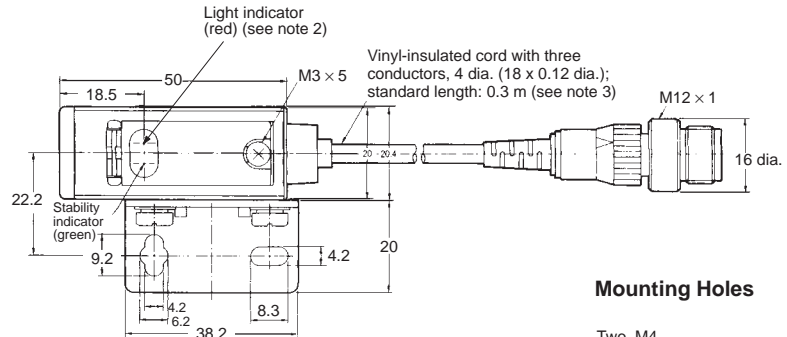
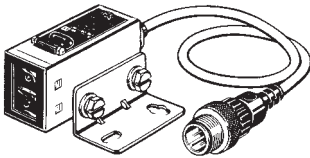

- Note:**
1. The mounting bracket can be attached to side A.
 2. The emitter for through-beam sensors have only the power supply indicator.
 3. The cord for emitters for through-beam sensors is two-conductor, 4 dia. (27 x 12 dia.).
 4. Position of optical axis for through-beam sensors.

**E3S-C□6□-M1J
(Vertical)**

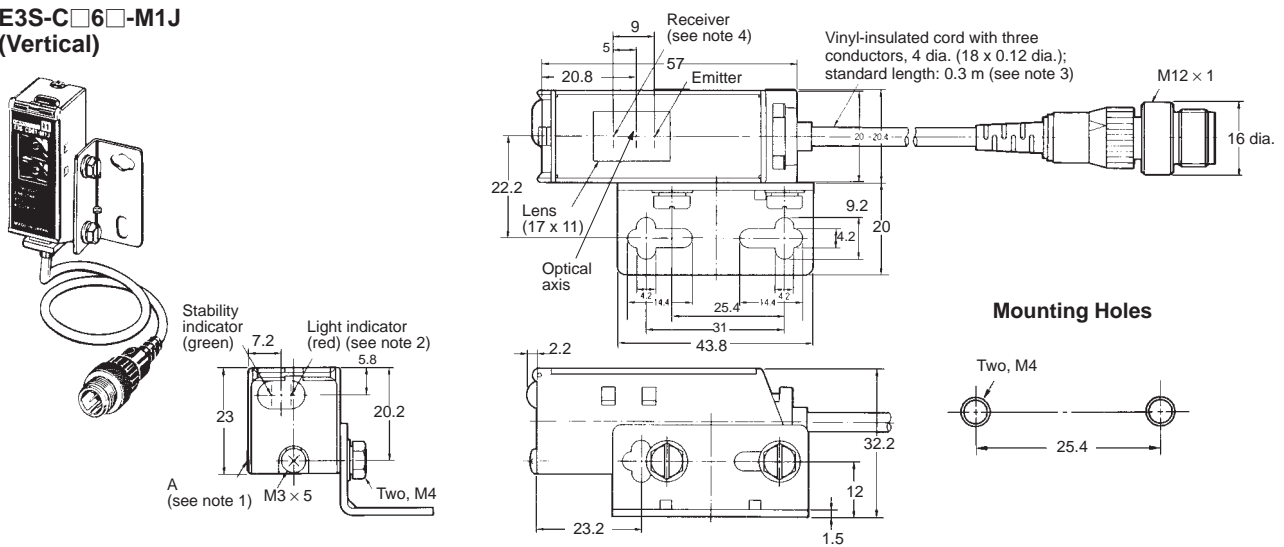

- Note:**
1. The mounting bracket can be attached to side A.
 2. The emitter for through-beam sensors have only the power supply indicator.
 3. The cord for emitters for through-beam sensors is two-conductor, 4 dia. (27 x 12 dia.).
 4. Position of optical axis for through-beam sensors.

Attachments

E39-R1 Retroreflector

(Retroreflective type, provided with the E3S-CR11(-M1J)/CR61(-M1J))

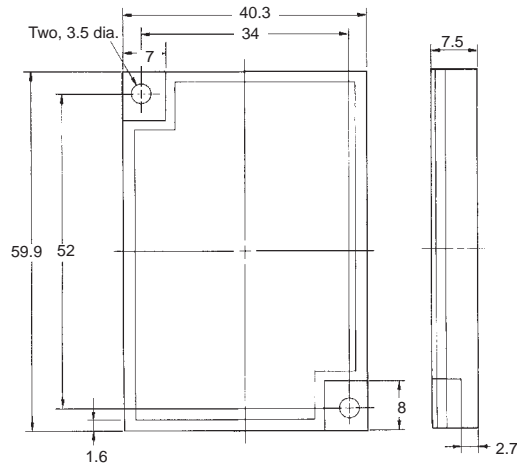
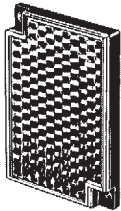

E39-L86 Special Mounting Bracket

(Vertical/E3S-□□□□43 for adjustment of the Photoelectric Sensor's optical axis direction)

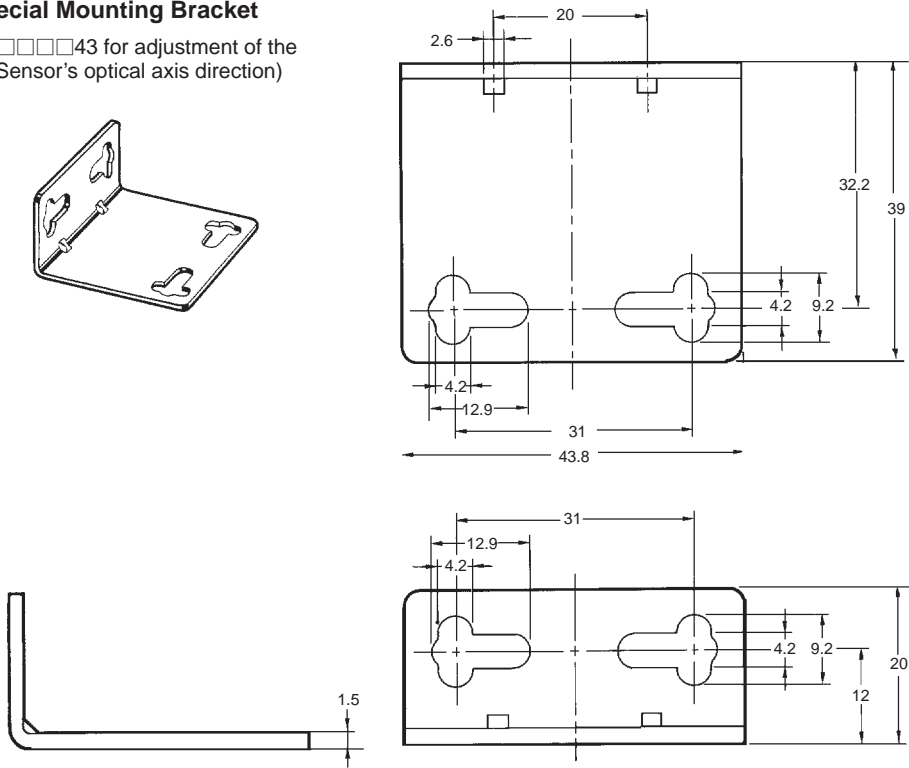

Sensing Face Direction of the E3S Series

Through-beam

E3S-5E43

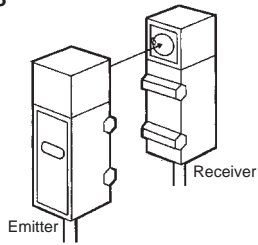

Retroreflective/Diffuse Reflective

E3S-DS30E43

E3S-R2E43

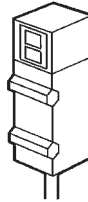

E39-L87 Special Mounting Bracket

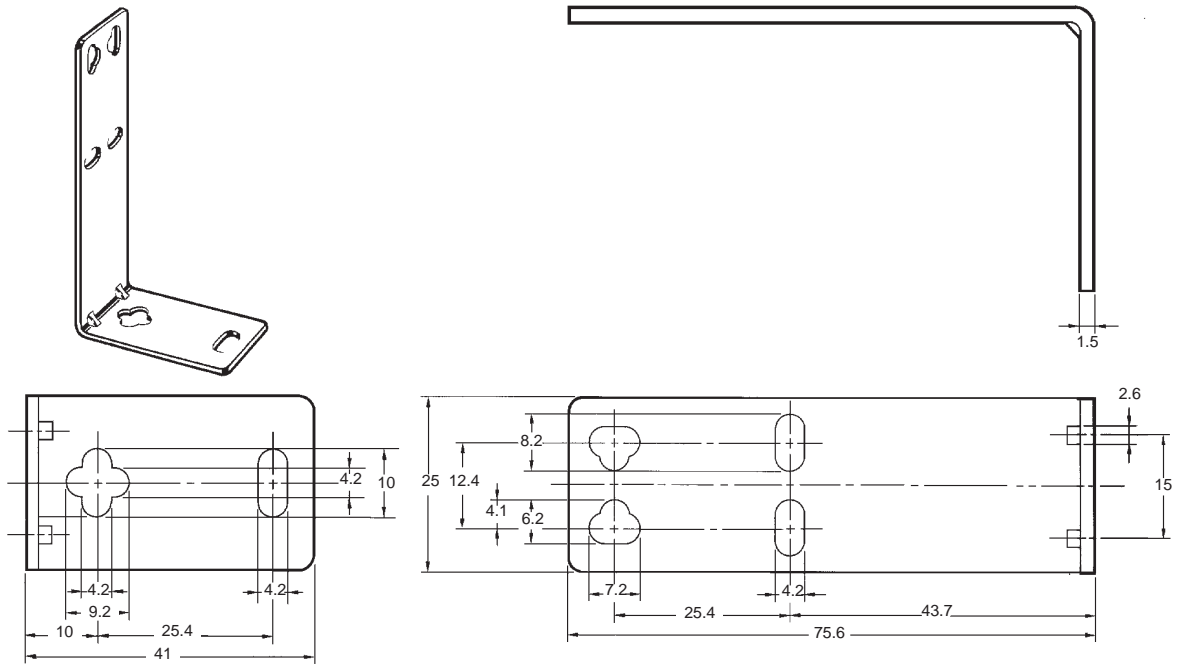

E39-S61 Slit for E3S-C

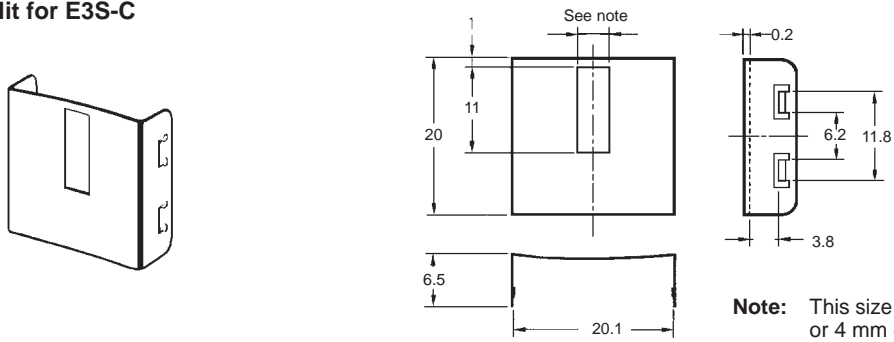

Note: This size is 0.5 mm, 1 mm, 2 mm, or 4 mm depending on the type.

Installation

■ Connections

Load (Relay)

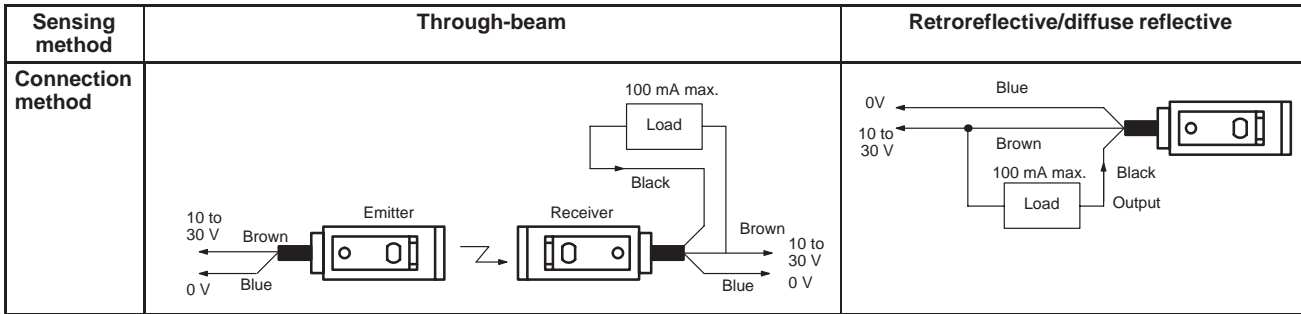

Note: If the load is a relay, insert a surge absorbing diode between the coils of the relay.
The connection examples are for sensors with the NPN output.

With Sensor Controller (S3D2)

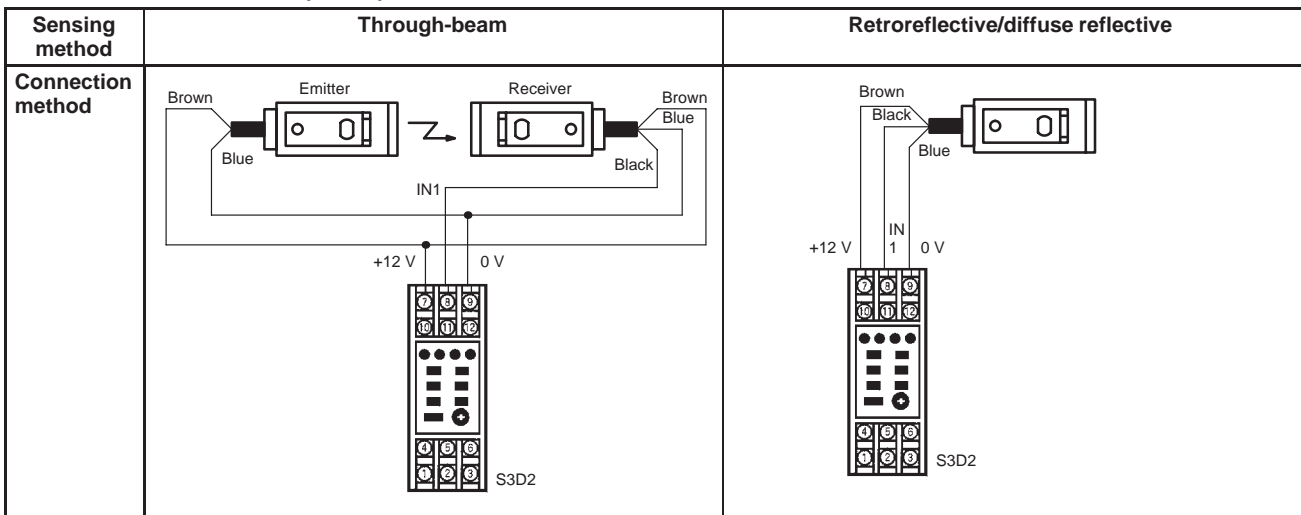

Precautions

Connection

If the input/output lines of the photoelectric sensor are placed in the same conduit or duct as power lines or high-voltage lines, the photoelectric sensor could be induced to malfunction, or even be damaged, by electrical noise. Either separate the wiring, or use shielded lines as input/output lines to the photoelectric sensor.

The cord connected to the E3S-C can be extended up to 100 m provided that the diameter of each wire of the cord is 0.3 mm² minimum.

Startup Operation

A maximum of 100 ms is required from the time power is turned on until the E3S-C is able to detect objects. If power is supplied to the loads and the E3S-C from different sources, turn on power to the E3S-C first.

Power Supply

If a standard switching regulator is used as a power supply, the frame ground (FG) terminal and the ground (G) terminal must be grounded, or otherwise the E3S-C may malfunction, due to the switching noise of the power supply.

Water Resistivity

Do not use the E3S-C in water, in the rain, or outdoors.

To ensure the water resistivity of the E3S-C, tighten the screws of the operation panel cover to a torque of 3.5 to 5.5 kgf • cm (0.34 N • m to 0.54 N • m).

Oil and Chemical Resistivity

Do not use the E3S-C in oils or liquid chemicals.

Although the E3S-C is oil-resistive, refer to the following table before using the E3S-C in places where oil may be sprayed on the E3S-C.

Tests were carried out with the following oils and it was certified that the E3S-C resists these oils.

Oil	JIS classification	Product name	Kinematic viscosity (mm ² /s (cst)) at 40°C	PH
Lubricating oil	---	Velocite No.3	2.02	---
Water insoluble machining oil	No. 5, type 2	Daphnecut	10 min. and less than 50	
	No. 11, type 2	Yushiron Oil No. 2 ac	Less than 10	
Water soluble machining oil	No. 1, type W1	Yushiroken EC50T-3	---	7 to 9.5
		Yushiron Lubic HWC68		7 to 9.9
	No. 2, type W1	Griton 1700D		7 to 9.2
	No. 1, type W2	Yushiroken S50N		7 to 9.8

- Note:**
- The E3S-C maintained a minimum insulation resistance of 100 MΩ after the E3S-C was dipped in all the above oils at a temperature of 50°C for 240 hours.
 - When using the E3S-C in a place where an oil other than the ones listed above is sprayed on the E3S-C, refer to the above kinematic viscosity and pH values. The location may be suitable for the E3S-C if the kinematic viscosity and pH values of the oil are close to the above kinematic viscosity and pH values, but make sure that the oil does not contain any additive that may have a negative influence on the E3S-C.
 - JIS: Japan Industrial Standards

Cable

The E3S-C uses an oil-resistive cord to ensure oil resistivity.

Do not allow the cable to be repeatedly bent during application.

Do not allow the cable to be bent to a radius of less than 25 mm.

Mounting

When mounting the E3S-C, do not hit the E3S-C with a hammer, or the E3S-C will lose watertightness.

Use M4 screws to mount the E3S-C.

The tightening torque of each screw must be 12 kgf • m (1.18 N • m) maximum.

Mounting Bracket

When mounting the E3S-C with the mounting bracket so that sensing objects will be in the direction of the mechanical axis, use the optical axis lock holes.

If it is not possible to mount the E3S-C so that the sensing objects will be in the direction the mechanical axis, move the E3S-C upwards, downwards, to the left, or to the right and secure the E3S-C in the center of the range where the light indicator will be lit, at which time make sure that the stability indicator is lit.

Direct Mounting

Mount the E3S-C as shown in the following illustration.

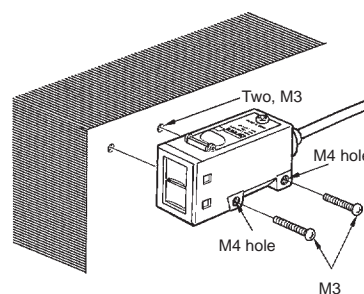
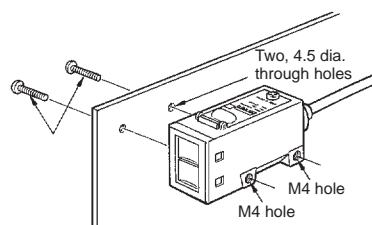

Malfunctioning

If an inverter motor or servomotor is used with the E3S-C, the frame ground (FG) terminal and the ground (G) terminal must be grounded, or otherwise the E3S-C may malfunction.

Optical Axis Adjustment

Direct the mounting axis of the mounting bracket in the direction where sensing objects will be located. The optical axis of the E3S-C coincides with the mounting axis of the mounting bracket, which enables the user to adjust the optical axis of the E3S-C with ease.

Optical Lock Holes

By tightening the optical axis lock holes with screws, the mounting bracket will be in the direction of the optical axis of the E3S-C.

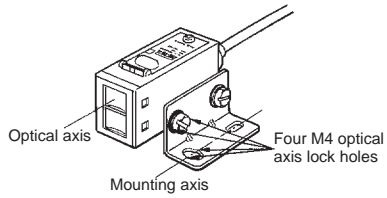

Optical Axis of Through-beam Sensor

The E3S-C through-beam models incorporate two lenses, one of which will be used as shown in the following illustration. When using a slit, the slit must be on the side where the lens to be used is located.

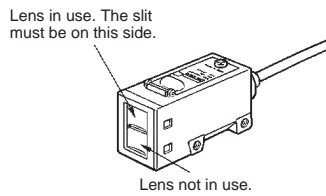

■ Replacing the E3S with the E3S-C

The following is the conversion table for changing from the E3S to the E3S-C.

Models

Conventional models	New models
E3S-5E4/5B4	E3S-CT11
E3S-5E41/5B41	E3S-CT61
E3S-R2E4/R2B4	E3S-CR11
E3S-R2E41/R2B41	E3S-CR61
E3S-DS30E4/DS30B4	E3S-CD11
E3S-DS30E41/DS30B41	E3S-CD61

Comparison

Item	E3S	E3S-C
Sensing distance	Through-beam: 5 m Retroreflective: 2 m (polarized) Diffuse reflective: 30 cm (infrared type)	Through-beam: 30 m Retroreflective: 3 m (polarized) Diffuse reflective: 70 cm/2 m (infrared type)
Response time	Through-beam: 3 ms max. Retroreflective/Diffuse reflective: 1 ms max.	1 ms max. (2 ms for 2-m diffusive models)
Enclosure rating	IP67 (with steel mounting bracket)	IP67, NEMA 6P, and IP67G (with stainless mounting bracket)
Vertical operation panel (sensitivity adjuster) (see note 1)	The sensitivity adjuster and indicator are on the face where the lens is located.	The sensitivity adjuster and indicator are on the top panel.
Outputs (see note 2)	Voltage and current	Open collector
Power supply voltage	12 to 24 VDC $\pm 10\%$	10 to 30 VDC
LED for emitter	Infrared	Infrared (red for retroreflective models)
Variation in sensing distance	Not specified (approx. 150% max.)	30% max.
Difference in direction between optical axis and mounting direction	Not specified (approx. 12° max.)	$\pm 2^\circ$ max.
Dark ON and light ON selection (see note 1)	Selected with the connection of power supply cord	Selector
Dimensions (see note 1)	Through-beam: 23 x 20 x 55 mm Diffuse reflective: 23 x 20 x 55 mm	Horizontal: 23 x 20 x 50 mm Vertical: 57 x 20 x 23 mm
Dimensions with mounting bracket attached (see note 1)	Through-beam/Retroreflective/Diffuse reflective: Horizontal: 55 x 40.2 x 32 mm Vertical: 63 x 40.2 x 32 mm	Through-beam/Retroreflective/Diffuse reflective: Horizontal: 52.6 x 40.2 x 29.5 mm Vertical: 60.6 x 40.2 x 32.2 mm
Mounting bracket	Iron	Stainless steel
Material (lens)	Polycarbonate	Acrylic

Note: 1. Especially take these items into consideration when replacing E3S models with E3S-C models.

- When connecting the E3S-C to a timer or counter with voltage input, be sure to connect a 4.7-k Ω resistor between the output and power supply lines. When the E3S-C is turned ON, a pulse signal may be output from the sensor.

ALL DIMENSIONS SHOWN ARE IN MILLIMETERS.

To convert millimeters into inches, multiply by 0.03937. To convert grams into ounces, multiply by 0.03527.

Cat. No. E229-E1-3 **In the interest of product improvement, specifications are subject to change without notice.**

OMRON Corporation

Systems Components Division H.Q.
28th Fl., Crystal Tower Bldg.
1-2-27, Shiromi, Chuo-ku,
Osaka 540 Japan
Phone: 06-949-6012 Fax: 06-949-6021

Printed in Japan
0397-1M (0194) a