



Housed in smaller, 1.6" x 2" x 0.40" (41 x 51 x 10.2mm) packages carrying the standard 2" x 2" pinout, C&D's new UHE Series DC/DC Converters deliver more current/power (up to 10A/30W) than currently available from either package size.

FEATURES

- The most I_{OUT}/P_{OUT} in this format
- Lower priced than bricks
- Small 1.6" x 2" x 0.4" plastic package with standard 2" x 2" pinout
- Output configurations:
1.2/1.5/1.8/2.5V_{OUT} @ 10 Amps
3.3/5V_{OUT} @ 25 Watts
5/12/15V_{OUT} @ 30 Watts
- Five input ranges from 9-75 Volts
- Efficiencies as high as 91.5%
- Stable no-load operation
- Optional Sense pins for low V_{OUT}
- Thermal shutdown, I/O protected
- 1500 Vdc I/O BASIC Insulation
- UL/EN60950 certified; CE marked for Q48 models
- RoHS compliant

PRODUCT OVERVIEW

The UHE 12-30W Series of high-efficiency, isolated DC/DC's provide output power ranging from 10 Amps @ 1.2V to 2 Amps @ 15V. Offering both 2:1 and 4:1 input voltage ranges, UHE's meet V_{IN} requirements from 9 to 75 Volts.

Taking full advantage of the synchronous-rectifier, forward topology, UHE's boast outstanding efficiency (some models exceed 91%) enabling full-power operation to ambient temperatures as high as +60°C, without air flow. Assembled using fully automated, SMT-on-pcb techniques, UHE's provide stable no-load operation, excellent line (±0.1%) and load (±0.15%) regulation, quick step response (200µsec), and low output ripple/noise (50-100mVp-p). Additionally, the UHE's unique output design eliminates one of the topology's few

shortcomings—output reverse conduction.

All devices feature full I/O fault protection including: input overvoltage and undervoltage shutdown, precise output overvoltage protection (a rarity on low-voltage outputs), output current limiting, short-circuit protection, and thermal shutdown.

All UHE models incorporate a V_{OUT} Trim function and an On/Off Control pin (positive or negative polarity). Low-voltage models (1.2V to 5V) offer optional sense pins facilitating either remote load regulation or current sharing for true N+1 redundancy. All models are certified to the BASIC insulation requirements of UL/EN60950, and 48V_{IN} (75V max.) models carry the CE mark. Selected models are RoHS compliant (Reduction of Hazardous Substances).

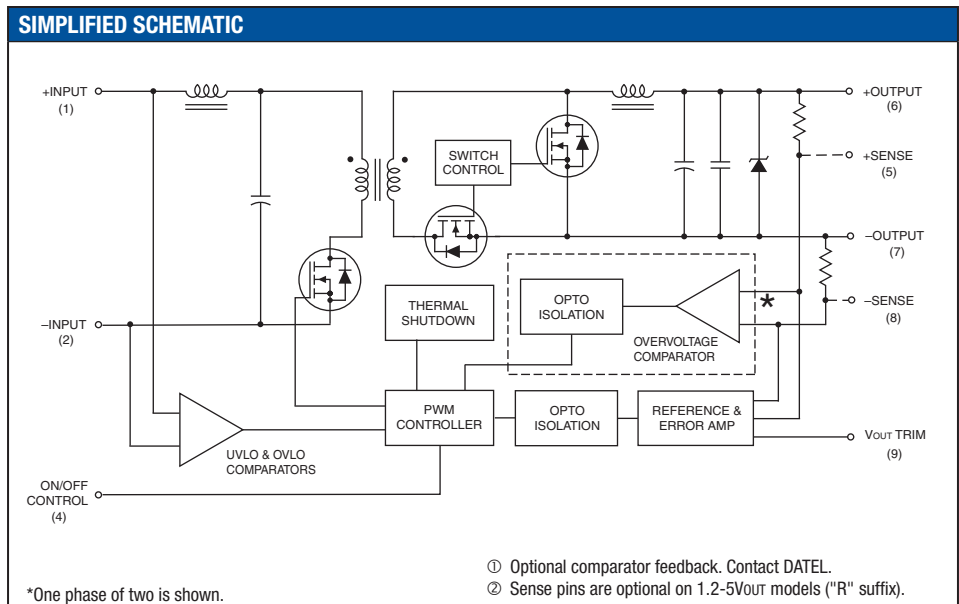

Typical topography is shown.



For full details go to www.cd4power.com/rohs

PERFORMANCE SPECIFICATIONS AND ORDERING GUIDE ①

Model Family (See model numbering on page 13)	Output						Input			Efficiency		Package (Case/ Pinout)
	V _{OUT} (Volts)	I _{OUT} (Amps)	R/N (mVp-p) ^②		Regulation (Max.)		V _{IN} Nom. (Volts)	Range (Volts)	I _{IN} ^③ (mA/A)			
			Typ.	Max.	Line	Load ^④						
UHE-1.2/10000-D12 ⑤	1.2	10	80	120	±0.1%	±0.15/0.625%	12	9-18	35/1.27	80%	82%	C32, P51/52
UHE-1.2/10000-D24 ⑤	1.2	10	80	120	±0.1%	±0.15/0.625%	24	18-36	35/0.63	81%	83%	C32, P51/52
UHE-1.2/10000-D48	1.2	10	80	120	±0.1%	±0.15/0.625%	48	36-75	35/0.31	81%	83%	C32, P51/52
UHE-1.5/10000-D12	1.5	10	55	80	±0.1%	±0.15/0.625%	12	9-18	35/1.56	81%	83%	C32, P51/52
UHE-1.5/10000-D24	1.5	10	55	80	±0.1%	±0.15/0.625%	24	18-36	35/0.76	84%	86%	C32, P51/52
UHE-1.5/10000-D48	1.5	10	55	80	±0.1%	±0.15/0.625%	48	36-75	35/0.38	82%	84%	C32, P51/52
UHE-1.8/10000-D12 ⑤	1.8	10	55	80	±0.1%	±0.15/0.625%	12	9-18	35/1.81	84%	85.5%	C32, P51/52
UHE-1.8/10000-D24	1.8	10	55	80	±0.1%	±0.15/0.625%	24	18-36	35/0.89	85.5%	87%	C32, P51/52
UHE-1.8/10000-D48	1.8	10	50	75	±0.1%	±0.15/0.625%	48	36-75	35/0.46	83.5%	85%	C32, P51/52
UHE-2.5/10000-D12	2.5	10	50	75	±0.1%	±0.15/0.5%	12	9-18	35/2.48	85%	87%	C32, P51/52
UHE-2.5/10000-D24	2.5	10	50	75	±0.1%	±0.15/0.5%	24	18-36	35/1.23	86%	88%	C32, P51/52
UHE-2.5/10000-D48	2.5	10	50	75	±0.1%	±0.15/0.5%	48	36-75	35/0.61	86%	88%	C32, P51/52
UHE-3.3/7500-Q12	3.3	7.5	50	70	±0.1%	±0.15/0.3%	24	9-36	50/1.2	86.5%	88%	C32, P51/52
UHE-3.3/7500-Q48	3.3	7.5	60	90	±0.1%	±0.15/0.3%	48	18-75	38/0.6	87.5%	89.5%	C32, P51/52
UHE-3.3/7500-D48	3.3	7.5	60	90	±0.1%	±0.15/0.3%	48	36-75	35/0.6	88.5%	91%	C32, P51/52
UHE-3.3/7500-D48T	3.3	7.5	80	100	±0.1%	±0.25%	48	36-75	35/0.58	87%	88.5%	C32, P51
UHE-5/5000-Q12	5	5	50	70	±0.1%	±0.15/0.3%	24	9-36	50/1.22	86%	87.5%	C32, P51/52
UHE-5/5000-Q48	5	5	60	90	±0.05%	±0.15/0.3%	48	18-75	35/0.6	87.5%	90%	C32, P51/52
UHE-5/6000-Q12	5	6	50	70	±0.075%	±0.15%	24	9-36	50/1.44	86.5%	87%	C32, P51/52
UHE-5/6000-D48	5	6	80	100	±0.1%	±0.25/0.5%	48	36-75	45/0.73	87.5%	89%	C32, P51/52
UHE-5/6000-D48T	5	6	80	100	±0.1%	±0.25%	48	36-75	45/0.7	87.5%	89%	C32, P51
UHE-5/6000-Q48T	5	6	90	125	±0.1%	±0.45%	48	18-75	38/0.71	86%	87.5%	C32, P51
UHE-12/2500-Q12	12	2.5	100	120	±0.1%	±0.3%	24	9-36	145/1.5	85%	87.5%	C32, P51
UHE-12/2500-D12	12	2.5	65	100	±0.1%	±0.3%	12	9-18	90/2.92	87%	89%	C32, P51
UHE-12/2500-D24	12	2.5	65	100	±0.1%	±0.3%	24	18-36	55/1.44	88%	90%	C32, P51
UHE-12/2500-Q48	12	2.5	100	120	±0.1%	±0.3%	48	18-75	45/0.72	88%	90.5%	C32, P51
UHE-12/2500-D48	12	2.5	60	100	±0.1%	±0.3%	48	36-75	30/0.7	90%	92%	C32, P51
UHE-15/2000-D12	15	2	70	100	±0.1%	±0.3%	12	9-18	110/2.92	87%	89%	C32, P51
UHE-15/2000-Q12	15	2	70	100	±0.1%	±0.5%	24	9-36	50/1.42	86%	88%	C32, P51
UHE-15/2000-D24	15	2	70	100	±0.1%	±0.3%	24	18-36	70/1.44	88%	90%	C32, P51
UHE-15/2000-Q48	15	2	100	150	±0.1%	±0.3%	48	18-75	45/0.72	88%	90.5%	C32, P51
UHE-15/2000-D48	15	2	70	100	±0.1%	±0.3%	48	36-75	35/0.7	90%	92%	C32, P51

① Typical at T_A = +25°C under nominal line voltage and full-load conditions, unless noted.

② Ripple/Noise (R/N) is tested/specified over a 20MHz bandwidth. All models are specified with an external 0.47µF multi-layer ceramic capacitor installed across their output pins.

③ Nominal line voltage, no-load/full-load conditions.

④ Devices have no minimum-load requirements and will regulate under no-load conditions. Regulation specifications describe the output voltage deviation as the line voltage or load (with/without sense option) is varied from its nominal/midpoint value to either extreme.

⑤ Contact C&D for availability.

MECHANICAL SPECIFICATIONS

INPUT/OUTPUT CONNECTIONS		
Pin	Function P51	Function P52
1	+Input	+Input
2	-Input	-Input
3	No Pin	No Pin
4	On/Off Control	On/Off Control
5	No Pin	Sense*
6	+Output	+Output
7	-Output	-Output
8	No Pin	-Sense*
9	Trim	Trim

* Pins 5 and 8 are installed for optional R-suffix versions of 1.2-5V_{OUT} models.

See page 13 for complete Part Number structure & ordering details.

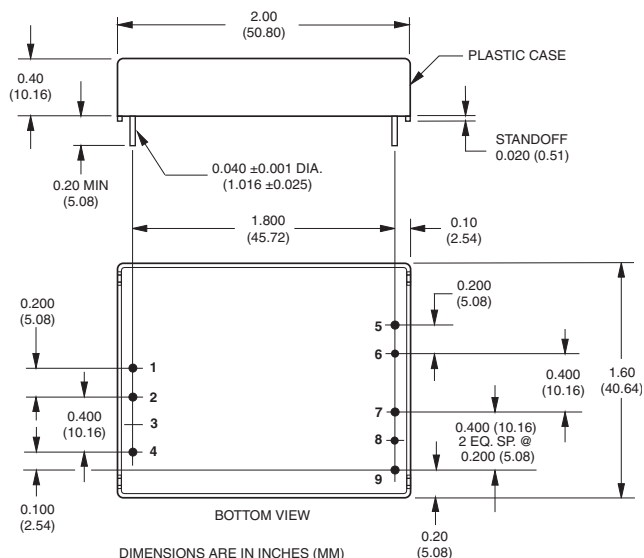

Performance/Functional Specifications

Typical @ T_A = +25°C under nominal line voltage and full-load conditions, unless noted. ⁽¹⁾ ⁽²⁾

Input	
Input Voltage Range:	
D12 Models (start up at 10V max.)	9-18 Volts (12V nominal)
Q12 Models (start up at 10V max.)	9-36 Volts (24V nominal)
D24 Models	18-36 Volts (24V nominal)
Q48 Models	18-75 Volts (48V nominal)
D48 Models	36-75 Volts (48V nominal)
Overvoltage Shutdown:	
D12 Models	18.5-23 Volts
Q12/D24 Models	37-42 Volts
D48/Q48 Models	Not applicable
Start-Up Threshold: ⁽²⁾	
D12/Q12 Models	9.4-10 Volts
D24/Q48 Models	15.5-18 Volts
D48 Models	33.5-36 Volts
Undervoltage Shutdown: ⁽²⁾	
D12/Q12 Models	7.0-8.8 Volts
D24/Q48 Models	15-17 Volts
D48 Models	32-35.5 Volts
Input Current:	
Normal Operating Conditions	See Ordering Guide
Standby Mode (Off, OV, UV)	5mA
Input Reflected Ripple Current ⁽³⁾	10mA _{p-p}
Input Filter Type	LC or Pi type
Reverse-Polarity Protection	Brief duration, 5A maximum
Remote On/Off Control (Pin 4): ⁽⁴⁾	
Positive Logic (Standard)	On = open, open collector, or +13V to V _{IN} applied. I _{IN} = 2.6mA max. Off = pulled low to 0-0.8V. I _{IN} = 2mA max.
Negative Logic ("N" Suffix Models)	On = pulled low to 0-0.8V. I _{IN} = 6mA max. Off = open, open collector or +3.5V to V _{IN} applied. I _{IN} = 1mA max.
Output	
V _{OUT} Accuracy (50% load):	
Initial	±1.5%
Temperature Coefficient	±0.02% per °C
Extreme ⁽⁵⁾	±3%
Minimum Loading for Specification: ⁽²⁾	No load
Ripple/Noise (20MHz BW) ⁽¹⁾	See Ordering Guide
Line/Load Regulation	See Ordering Guide
Efficiency	See Ordering Guide
V _{OUT} Trim Range ⁽⁶⁾	±5% minimum (±10% for T models)
Remote Sense Compensation ⁽²⁾	±5%
Isolation Voltage:	
Input-to-Output	1500Vdc minimum (BASIC)
Isolation Capacitance	650pF
Isolation Resistance	100MΩ
Current Limit Inception (@98%V _{OUT}): ⁽⁷⁾	
10 Amp Models	12-15 Amps
7.5 Amp Models	8.2-11.5 Amps
5/6 Amp Models	6.5-8.5 Amps
2.5 Amp Models	2.6-3.75 Amps
2.0 Amp Models	2.1-3 Amps
Short Circuit Current (Hiccup)	1.5-2.3 Amps

Output	
Overvoltage Protection:	Magnetic feedback
1.2V Outputs	1.5-2.1 Volts
1.5V Outputs	1.8-2.4 Volts
1.8V Outputs	2.2-2.8 Volts
2.5V Outputs	2.8 to 3.2 Volts
3.3V Outputs	4 to 4.8 Volts
5V Outputs	6.1-7.5 Volts
12V Outputs	12.7-13.5 Volts
15V Outputs	15.8-16.2 Volts
Maximum Capacitive Loading:	10,000µF (1.2-5V _{OUT})
(Low ESR capacitor)	2,000µF (12-15V _{OUT})
Dynamic Characteristics	
Dynamic Load Response:	
(50-100% load step to ±3% V _{OUT})	200µsec maximum ⁽⁸⁾
Start-Up Time: ⁽⁸⁾	8msec typical
V _{IN} to V _{OUT} and On/Off to V _{OUT}	15msec maximum
UHE-15/2000-Q12	30mS typ., 50mS max.
Switching Frequency	150-350kHz (model dependent)
Environmental	
MTBF ⁽⁹⁾	TBC million hours
Operating Temperature (Ambient): ⁽¹⁰⁾	
Without Derating	-40 to +65°C (model dependent)
With Derating	To +100°C (see Derating Curves)
Thermal Shutdown	+115°C
Storage Temperature	-55 to +125°C
Flammability	94V-0
Physical	
Dimensions	1.6" x 2" x 0.40" (40.64 x 50.8 x 10.16mm)
Case Material	Diallyl Phthalate
Pin Material	Gold-plated copper alloy
Weight	1.51 ounces (46.9 grams)
Primary to Secondary Insulation Level	Basic

- (1) All models are tested and specified with a single, external, 0.47µF, multi-layer ceramic output capacitor and no external input capacitors, unless otherwise noted. All models will effectively regulate under no-load conditions (with perhaps a slight increase in output ripple/noise).
- (2) See Technical Notes/Performance Curves for additional explanations and details.
- (3) Input Ripple Current is tested/specified over a 5-20MHz bandwidth with an external 33µF input capacitor and a simulated source impedance of 220µF and 12µH. See I/O Filtering, Input Ripple Current and Output Noise for details.
- (4) The On/Off Control is designed to be driven with open-collector (or equivalent) logic or the application of appropriate voltages (referenced to -Input (pin 2)). Applying a voltage to the On/Off Control pin when no input voltage is applied to the converter can cause permanent damage. See Remote On/Off Control for more details.
- (5) Extreme Accuracy refers to the accuracy of either trimmed or untrimmed output voltages over all normal operating ranges and combinations of input voltage, output load and temperature.
- (6) Tie the Output Trim pin (pin 9) to +Output (pin 6) for maximum trim down or to -Output (Output Return/Common, pin 7) for maximum trim up. See Output Trimming for detailed trim equations.
- (7) The Current-Limit-Inception point is the output current level at which the converter's power-limiting circuitry drops the output voltage 2% from its initial value. See Output Current Limiting and Short-Circuit Protection for more details.
- (8) For Start-Up-Time specifications, output settling time is defined as the output voltage having reached ±1% of its final value at maximum load current.
- (9) MTBF's are calculated using TELCORDIA SR-332 Method 1 Case, ground fixed, +25°C ambient air and full-load conditions. Contact C&D for demonstrated life-test data.
- (10) All models are fully operational and meet all published specifications, including "cold start," at -40°C.

Absolute Maximum Ratings

Input Voltage:	
Continuous:	
D12 Models	23 Volts
D24/Q12 Models	42 Volts
D48/Q48 Models	81 Volts
Transient (100msec):	
D12 Models	25 Volts
D24/Q12 Models	50 Volts
D48/Q48 Models	100 Volts
On/Off Control (pin 4) Max. Voltages	
Referenced to -Input (pin 2)	
No Suffix	+VIN
"N" Suffix	+7 Volts
Input Reverse-Polarity Protection	Current must be <5 Amps. Brief duration only. Fusing recommended.
Output Current	Current limited. Devices can withstand sustained output short circuits without damage.
Case Temperature	+100°C
Storage Temperature	-55 to +125°C
Lead Temperature (soldering, 10 sec.)	+300°C

These are stress ratings. Exposure of devices to any of these conditions may adversely affect long-term reliability. Proper operation under conditions other than those listed in the Performance/Functional Specifications Table is not implied.

TECHNICAL NOTES

Input Fusing

Certain applications and/or safety agencies may require the installation of fuses at the inputs of power conversion components. Fuses should also be used if the possibility of sustained, non-current-limited, input-voltage polarity reversals exists. For DATEL UHE 12-30 Watt DC/DC Converters, you should use slow-blow type fuses, installed in the ungrounded input supply line, with values no greater than the following.

Model Output/Input	Fuse Values in Amps				
	D12	Q12	D24	Q48	D48
1.2 V _{OUT}	3	--	2	--	1
1.5 V _{OUT}	4	--	2	--	1
1.8 V _{OUT}	5	--	2.5	--	1
2.5 V _{OUT}	5	--	2.5	--	1
3.3 V _{OUT}	--	7.5	-	3	1.5
5 V _{OUT}	--	5	-	3	2
12 V _{OUT}	6	3	3	5	2
15 V _{OUT}	6	3	3	5	2

All relevant national and international safety standards and regulations must be observed by the installer. For system safety agency approvals, the converters must be installed in compliance with the requirements of the end-use safety standard, e.g. IEC/EN/UL60950.

Input Undervoltage Shutdown and Start-Up Threshold

Under normal start-up conditions, devices will not begin to regulate until the ramping-up input voltage exceeds the Start-Up Threshold Voltage. Once operating, devices will not turn off until the input voltage drops below the Undervoltage Shutdown limit. Subsequent re-start will not occur until the input is brought back up to the Start-Up Threshold. This built in hysteresis prevents any unstable on/off situations from occurring at a single input voltage.

Start-Up Time

The V_{IN} to V_{OUT} Start-Up Time is the interval of time between the point at which the ramping input voltage crosses the Start-Up Threshold and the fully loaded output voltage enters and remains within its specified accuracy band. Actual measured times will vary with input source impedance, external input/output capacitance, and load. The UHE Series implements a soft start circuit that limits the duty cycle of its PWM controller at power up, thereby limiting the input inrush current.

The On/Off Control to V_{OUT} start-up time assumes the converter has its nominal input voltage applied but is turned off via the On/Off Control pin. The specification defines the interval between the point at which the converter is turned on and the fully loaded output voltage enters and remains within its specified accuracy band. Similar to the V_{IN} to V_{OUT} start-up, the On/Off Control to V_{OUT} start-up time is also governed by the internal soft start circuitry and external load capacitance.

The difference in start up time from V_{IN} to V_{OUT} and from On/Off Control to V_{OUT} is therefore insignificant.

Input Overvoltage Shutdown

All D12/Q12 and D24 Models of the UHE DC/DC converters are equipped with Input Overvoltage Protection. Input voltages exceeding the input overvoltage shutdown specification listed in the Performance/Functional Specifications will cause the device to shutdown. A built-in hysteresis for all models will not allow the converter to restart until the input voltage is sufficiently reduced.

All 48V_{IN} models have this overvoltage shutdown function disabled because of requirements for withstanding brief input surges to 100V for up to 100msec without output voltage interruption.

Please contact DATEL to have input overvoltage shutdown for D48/Q48 models enabled.

Input Source Impedance

UHE converters must be driven from a low ac-impedance input source. The DC/DC's performance and stability can be compromised by the use of highly inductive source impedances. The input circuit shown in Figure 2 is a practical solution that can be used to minimize the effects of inductance in the input traces. For optimum performance, components should be mounted close to the DC/DC converter. If the application has a high source impedance, low V_{IN} models can benefit of increased external input capacitance.

I/O Filtering, Input Ripple Current, and Output Noise

All models in the UHE 12-30 Watt DC/DC Converters are tested/specified for input reflected ripple current and output noise using the specified external input/output components/circuits and layout as shown in the following two figures.

External input capacitors (C_{IN} in Figure 2) serve primarily as energy-storage elements, minimizing line voltage variations caused by transient IR drops in conductors from backplane to the DC/DC. Input caps should be selected for bulk capacitance (at appropriate frequencies), low ESR, and high rms-ripple-current ratings. The switching nature of DC/DC converters requires that dc voltage sources have low ac impedance as highly inductive source impedance can affect system stability. In Figure 2, C_{BUS} and L_{BUS} simulate a typical dc voltage bus. Your specific system configuration may necessitate additional considerations.

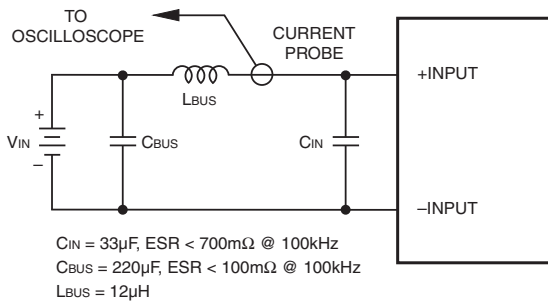

Figure 2. Measuring Input Ripple Current

In critical applications, output ripple/noise (also referred to as periodic and random deviations or PARD) may be reduced below specified limits using filtering techniques, the simplest of which is the installation of additional external output capacitors. These output caps function as true filter elements and should be selected for bulk capacitance, low ESR and appropriate frequency response. All external capacitors should have appropriate voltage ratings and be located as close to the converter as possible. Temperature variations for all relevant parameters should also be taken carefully into consideration.

The most effective combination of external I/O capacitors will be a function of line voltage and source impedance, as well as particular load and layout conditions. Our Applications Engineers can recommend potential solutions and discuss the possibility of our modifying a given device's internal filtering to meet your specific requirements. Contact our Applications Engineering Group for additional details.

In Figure 3, the two copper strips simulate real-world pcb impedances between the power supply and its load. In order to minimize measurement errors, scope measurements should be made using BNC connectors, or the probe ground should be less than 1/2 inch and soldered directly to the fixture.

Floating Outputs

Since these are isolated DC/DC converters, their outputs are "floating" with respect to their input. Designers will normally use the -Output (pin 7) as the ground/return of the load circuit. You can, however, use the +Output (pin 6) as ground/return to effectively reverse the output polarity.

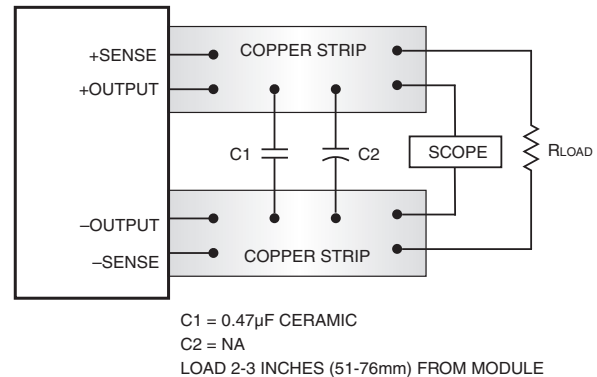

Figure 3. Measuring Output Ripple/Noise (PARD)

Minimum Output Loading Requirements

UHE converters employ a synchronous-rectifier design topology and all models regulate within spec and are stable under no-load to full load conditions. Operation under no-load conditions however might slightly increase the output ripple and noise.

Thermal Shutdown

These UHE converters are equipped with thermal-shutdown circuitry. If environmental conditions cause the internal temperature of the DC/DC converter to rise above the designed operating temperature, a precision temperature sensor will power down the unit. When the internal temperature decreases below the threshold of the temperature sensor, the unit will self start. See Performance/Functional Specifications.

Output Overvoltage Protection

UHE output voltages are monitored for an overvoltage condition via magnetic feedback. The signal is coupled to the primary side and if the output voltage rises to a level which could be damaging to the load, the sensing circuitry will power down the PWM controller causing the output voltages to decrease. Following a time-out period the PWM will restart, causing the output voltages to ramp to their appropriate values. If the fault condition persists, and the output voltages again climb to excessive levels, the overvoltage circuitry will initiate another shutdown cycle. This on/off cycling is referred to as "hiccup" mode.

Contact DATEL for an optional output overvoltage monitor circuit using a comparator which is optically coupled to the primary side thus allowing tighter and more precise control.

Current Limiting

As soon as the output current increases to 10% to 50% above its rated value, the DC/DC converter will go into a current-limiting mode. In this condition, the output voltage will decrease proportionately with increases in output current, thereby maintaining somewhat constant power dissipation. This is commonly referred to as power limiting. Current limit inception is defined as the point at which the full-power output voltage falls below the specified tolerance. See Performance/Functional Specifications. If the load current, being drawn from the converter, is significant enough, the unit will go into a short circuit condition as specified under "Performance."

Short Circuit Condition

When a converter is in current-limit mode, the output voltage will drop as the output current demand increases. If the output voltage drops too low, the magnetically coupled voltage used to develop primary side voltages will also drop, thereby shutting down the PWM controller. Following a time-out period, the PWM will restart causing the output voltages to begin ramping to their appropriate values. If the short-circuit condition persists, another shutdown cycle will be initiated. This on/off cycling is referred to as "hiccup" mode. The hiccup cycling reduces the average output current, thereby preventing internal temperatures from rising to excessive levels. The UHE is capable of enduring an indefinite short circuit output condition.

FEATURES AND OPTIONS

On/Off Control

The input-side, remote On/Off Control function (pin 4) can be ordered to operate with either polarity:

Standard models are equipped with Positive-polarity (no part-number suffix) and these devices are enabled when pin 4 is left open (or is pulled high, applying +13V to +VIN with respect to -Input, pin 2) as per Figure 4. Positive-polarity devices are disabled when pin 4 is pulled low (0 to 0.8V with respect to -Input).

Optional Negative-polarity devices ("N" suffix) are off when pin 4 is left open (or pulled high, applying +3.5V to +VIN), and on when pin 4 is pulled low (0 to 0.8V) with respect to -VIN as shown in Figure 5.

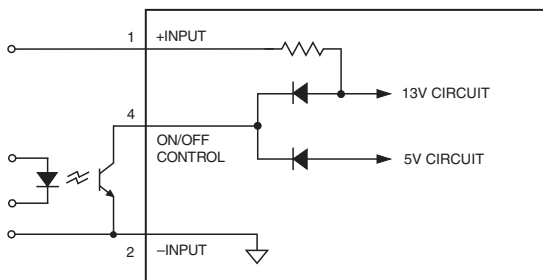

Figure 4. Driving the Positive Polarity On/Off Control Pin

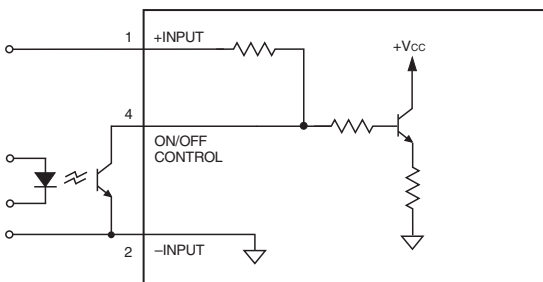

Figure 5. Driving the Negative Polarity On/Off Control Pin

Dynamic control of the remote on/off function is best accomplished with a mechanical relay or an open-collector/open-drain drive circuit (optically isolated if appropriate). The drive circuit should be able to sink appropriate current (see Performance Specs) when activated and withstand appropriate voltage when deactivated. Applying an external voltage to pin 4 when no input power is applied to the converter can cause permanent damage to the converter.

Trimming Output Voltage

UHE converters have a trim capability (pin 9) that allows users to adjust the output voltages $\pm 5\%$ of V_{OUT} ($\pm 10\%$ for T models). Adjustments to the output voltages can be accomplished via a trim pot (Figure 6) or a single fixed resistor as shown in Figures 7 and 8. A single fixed resistor can increase or decrease the output voltage depending on its connection. The resistor should be located close to the converter and have a TCR less than 100ppm/ $^{\circ}C$ to minimize sensitivity to changes in temperature. If the trim function is not used, leave the trim pin floating.

A single resistor connected from the Trim (pin 9) to the +Output (pin 6), or +Sense where applicable, will decrease the output voltage for all models with the exception of the 1.2V models, which will increase the output voltage in this configuration. A resistor connected from the Trim (pin 9) to the -Output (pin 7), or -Sense where applicable, will increase the output voltage for all models with the exception of the 1.2V models, which will decrease the output voltage in this configuration.

Trim adjustments greater than the specified $\pm 5\%$ can have an adverse affect on the converter's performance and are not recommended. Excessive voltage differences between V_{OUT} and Sense, in conjunction with trim adjustment of the output voltage, can cause the overvoltage protection circuitry to activate (see Performance Specifications for overvoltage limits). Power derating is based on maximum output current and voltage at the converter's output pins. Use of trim and sense functions can cause output voltages to increase, thereby increasing output power beyond the converter's specified rating or cause output voltages to climb into the output overvoltage region. Therefore:

$$(V_{OUT \text{ at pins}}) \times (I_{OUT}) \leq \text{rated output power}$$

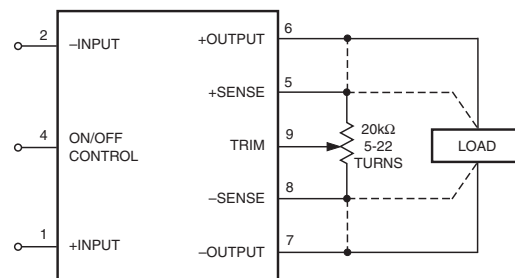

Figure 6. Trim Connections Using A Trimpot

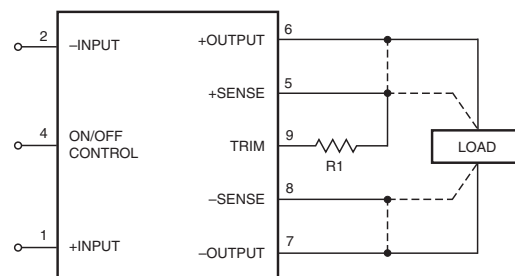

Figure 7. Trim Connections To Decrease Output Voltages Using a Fixed Resistor (for all models except 1.2V models which will increase V_{OUT})

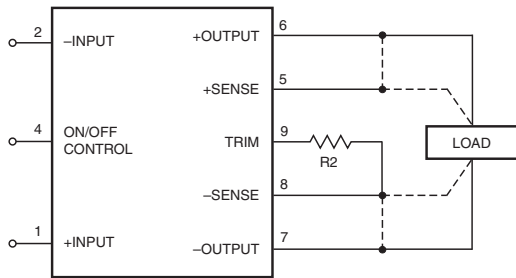

Figure 8. Trim Connections To Increase Output Voltages (for all models except 1.2V models which will decrease V_{out})

Trim Equations

Trim Up	Trim Down
UHE-1.2/10000-D12, -D24, -D48	
$R1 (k\Omega) = \frac{1.308(V_o - 0.793)}{V_o - 1.2} - 1.413$	$R2 (k\Omega) = \frac{1.037}{1.2 - V_o} - 1.413$
UHE-1.5/10000-D12, -D24, -D48	
$R1 (k\Omega) = \frac{0.459(V_o - 0.7096)}{1.5 - V_o} - 3.169$	$R2 (k\Omega) = \frac{0.3232}{V_o - 1.5} - 3.169$
UHE-1.8/10000-D12, -D24, -D48	
$R1 (k\Omega) = \frac{1.027(V_o - 0.9352)}{1.8 - V_o} - 7.596$	$R2 (k\Omega) = \frac{0.9647}{V_o - 1.8} - 7.596$
UHE-2.5/10000-D12, -D24, -D48	
$R1 (k\Omega) = \frac{2.226(V_o - 0.9625)}{2.5 - V_o} - 7.503$	$R2 (k\Omega) = \frac{2.142}{V_o - 2.5} - 7.503$
UHE-3.3/7500-Q12, -Q24, -D48	
$R1 (k\Omega) = \frac{3.21(V_o - 1.759)}{3.3 - V_o} - 22.42$	$R2 (k\Omega) = \frac{5.65}{V_o - 3.3} - 22.42$
UHE-5/5000-Q12, -Q48, UHE-5/6000-D48, -Q48	
$R1 (k\Omega) = \frac{2.15(V_o - 2.592)}{5 - V_o} - 15.52$	$R2 (k\Omega) = \frac{5.58}{V_o - 5} - 15.52$
UHE-12/2500-D12, -D24, -D48, -Q12, -Q48	
$R1 (k\Omega) = \frac{10(V_o - 2.5)}{12 - V_o} - 34.8$	$R2 (k\Omega) = \frac{29.5}{V_o - 12} - 34.8$
UHE-15/2000-D12, -D24, -D48, -Q12, -Q48	
$R1 (k\Omega) = \frac{13.3(V_o - 2.5)}{15 - V_o} - 43.3$	$R2 (k\Omega) = \frac{37.875}{V_o - 15} - 43.3$

UHE-3.3/7500-D48T (Quantity order only)

Trim Up $R1 (k\Omega) = (2.54/y - 4.08)/2$ where $y = (3.3 - V_o)/3.3$
 Trim Down $R2 (k\Omega) = 1.55/2y$ where $y = (V_o - 3.3)/3.3$

UHE-5/6000-Q48T, -D48T (Quantity order only)

Trim Up $R1 (k\Omega) = 1.25/y - 2.69$ where $y = (5 - V_o)/5$
 Trim Down $R2 (k\Omega) = 1.25/y$ where $y = (V_o - 5)/5$

Note: Resistor values are in $k\Omega$. Adjustment accuracy is subject to resistor tolerances and factory-adjusted output accuracy. V_o = desired output voltage.

Remote Sense (Optional on 1.2-5V_{out} models)

Note: The Sense and V_{out} lines are internally connected through 10Ω resistors. Nevertheless, if the sense function is not used for remote regulation the user should connect the +Sense to + V_{out} and -Sense to - V_{out} at the DC/DC converter pins.

UHE series converters have a sense feature to provide point of use regulation, thereby overcoming moderate IR drops in pcb conductors or cabling. The remote sense lines carry very little current and therefore require minimal cross-sectional-area conductors. The sense lines are used by the feedback control-loop to regulate the output. As such, they are not low impedance points and must be treated with care in layouts and cabling. Sense lines on a pcb should be run adjacent to dc signals, preferably ground. In cables and discrete wiring applications, twisted pair or other techniques should be implemented.

UHE series converters will compensate for drops between the output voltage at the DC/DC and the sense voltage at the DC/DC provided that:

$$|V_{out(+)} - V_{out(-)}| - [Sense(+)] - Sense(-)] \leq 5\% V_{out}$$

Output overvoltage protection is monitored at the output voltage pin, not the Sense pin. Therefore, excessive voltage differences between V_{out} and Sense in conjunction with trim adjustment of the output voltage can cause

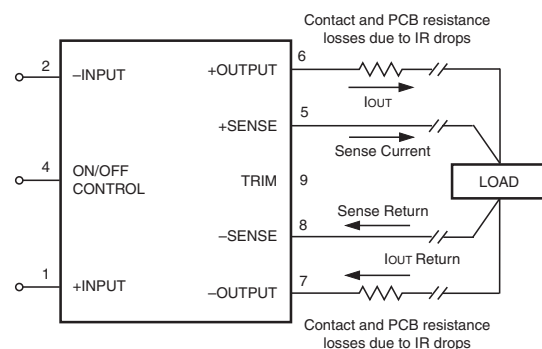
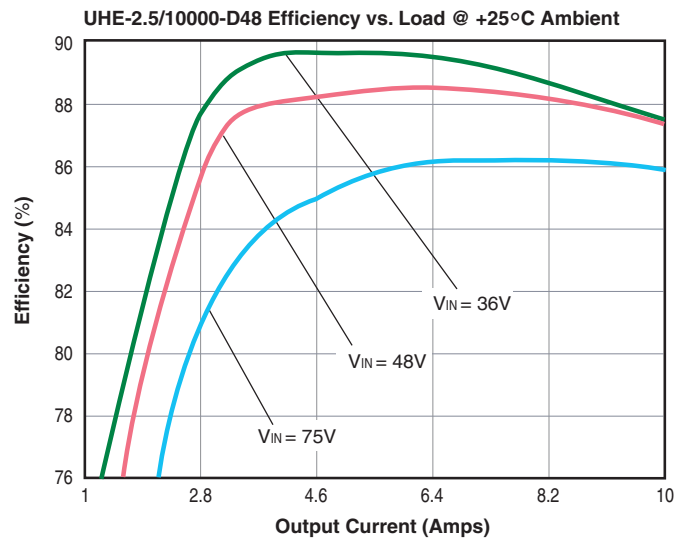
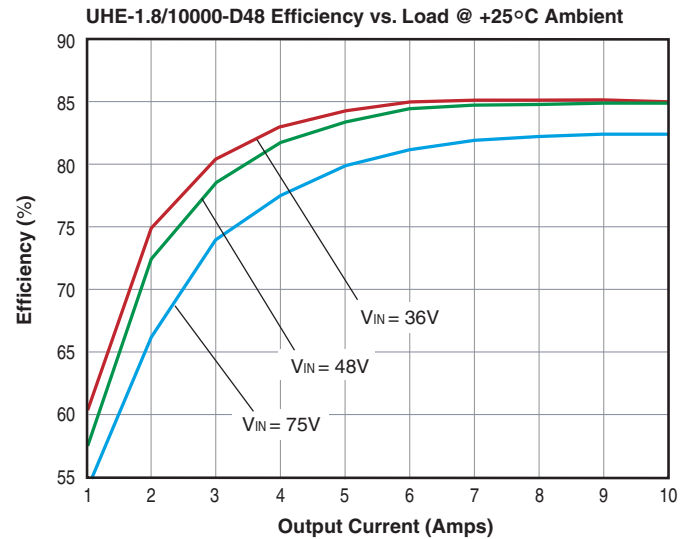
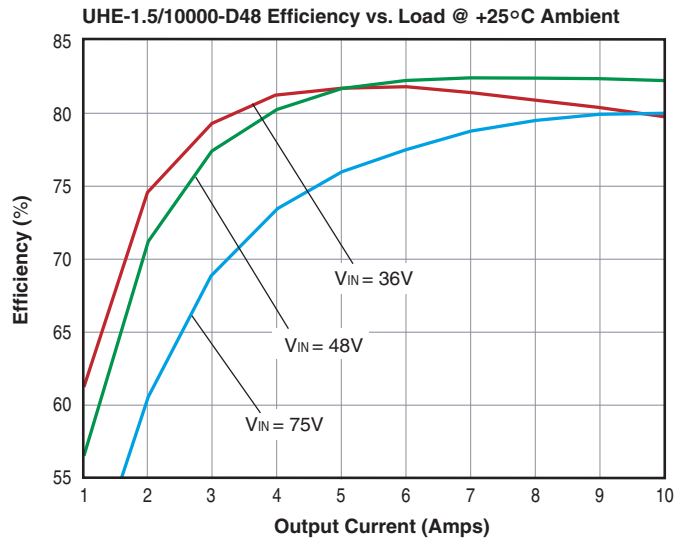
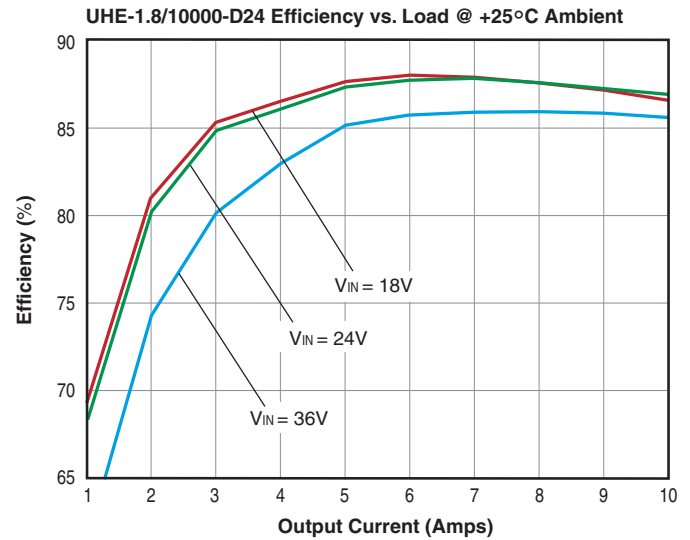
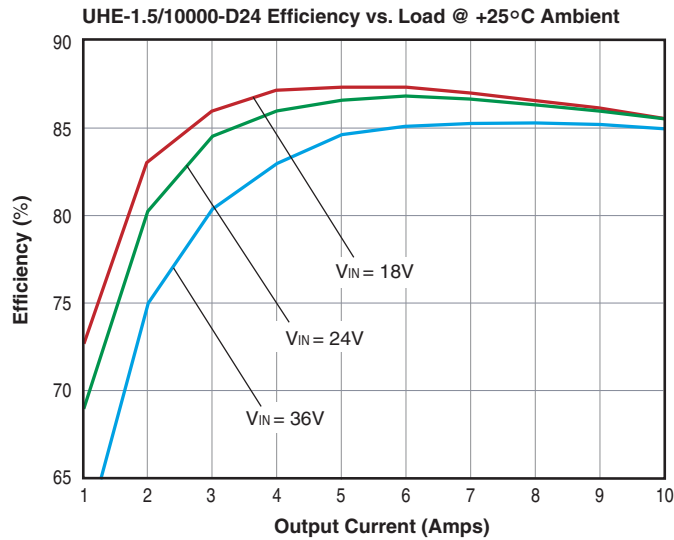

Figure 9. Remote Sense Circuit Configuration

the overvoltage protection circuitry to activate (see Performance Specifications for overvoltage limits). Power derating is based on maximum output current and voltage at the converter's output pins. Use of trim and sense functions can cause output voltages to increase thereby increasing output power beyond the UHE's specified rating or cause output voltages to climb into the output overvoltage region. Therefore, the designer must ensure:

$$(V_{out \text{ at pins}}) \times (I_{out}) \leq \text{rated output power}$$

TYPICAL PERFORMANCE CURVES



UHE-3.3/7500-Q12 Efficiency vs. Load @ +25°C Ambient

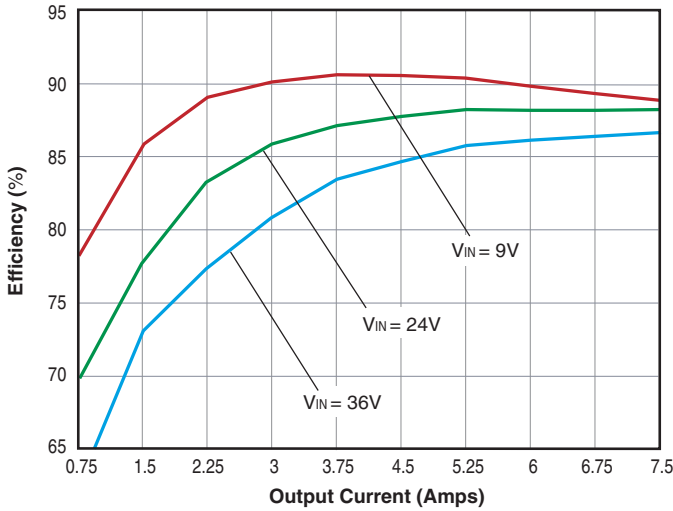

UHE-5/5000-Q12 Efficiency vs. Load @ +25°C Ambient

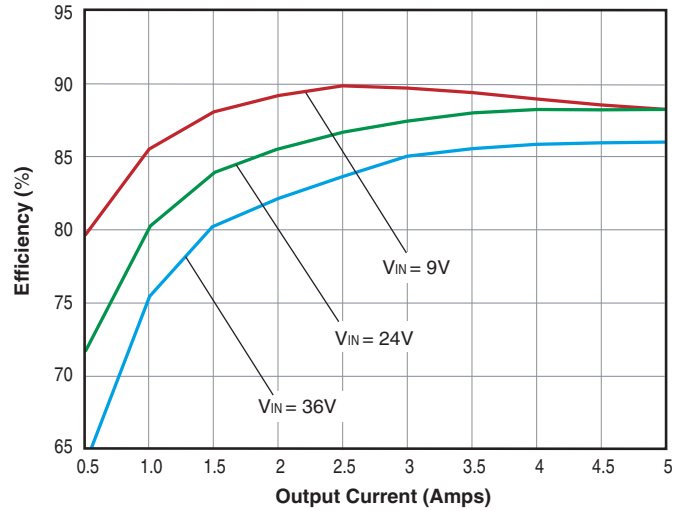

UHE-3.3/7500-Q48 Efficiency vs. Load @ +25°C Ambient

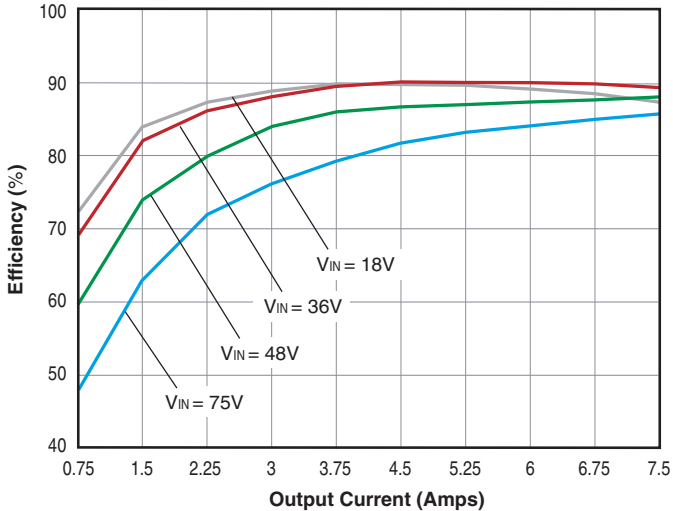

UHE-5/5000-Q48 Efficiency vs. Load @ +25°C Ambient

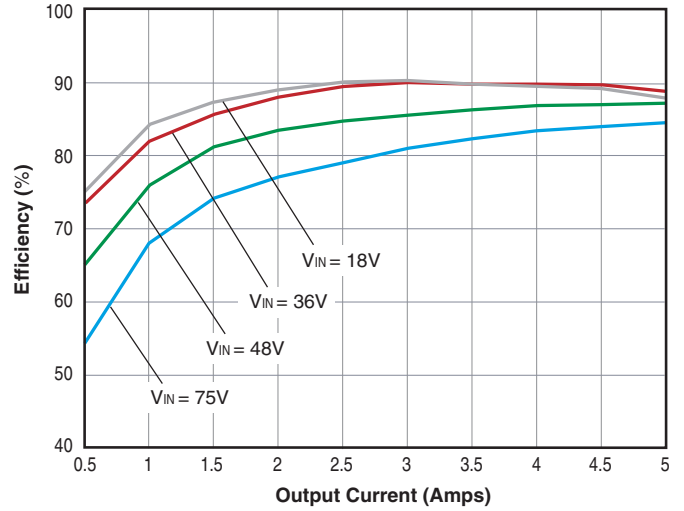

UHE-3.3/7500-D48 Efficiency vs. Load @ +25°C Ambient

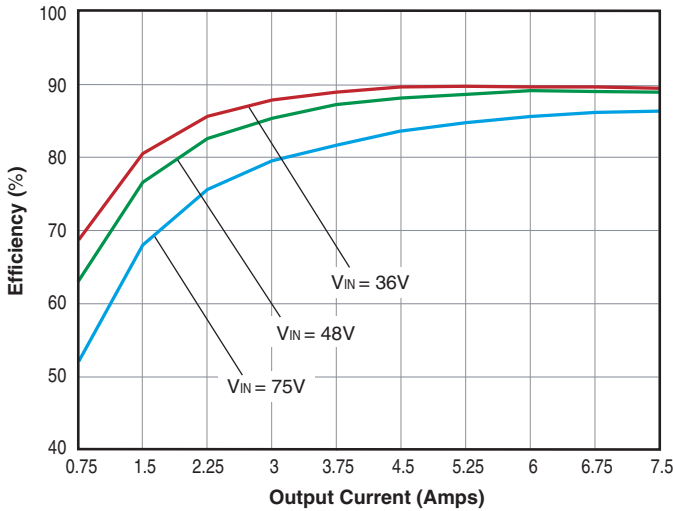

UHE-5/6000-D48 Efficiency vs. Load @ +25°C Ambient

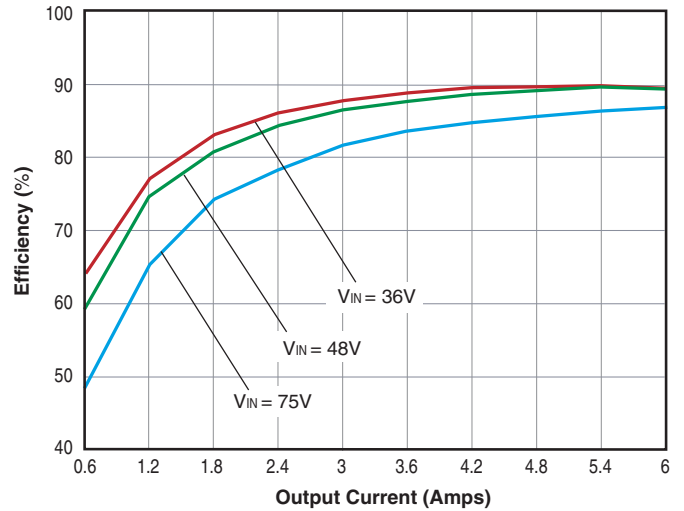

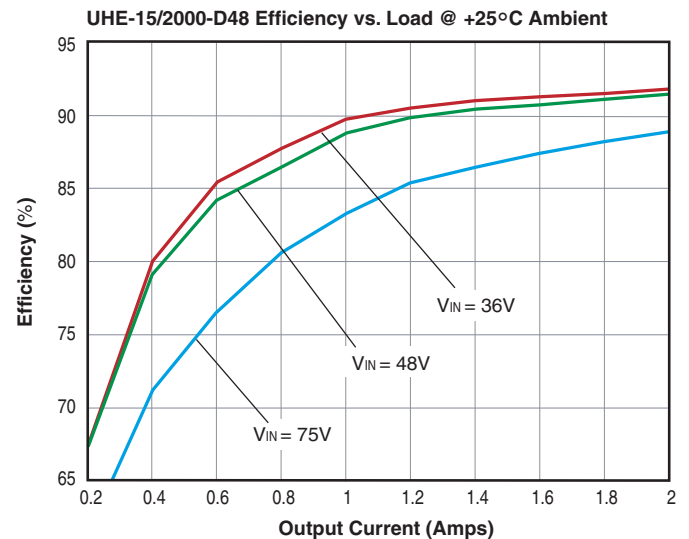
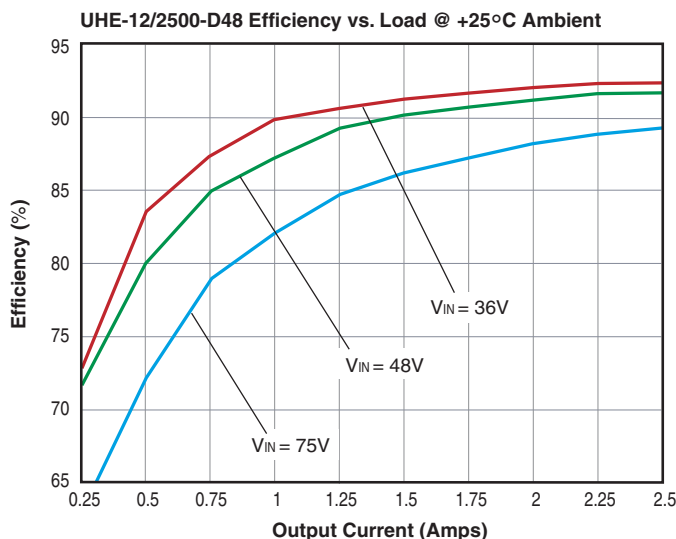
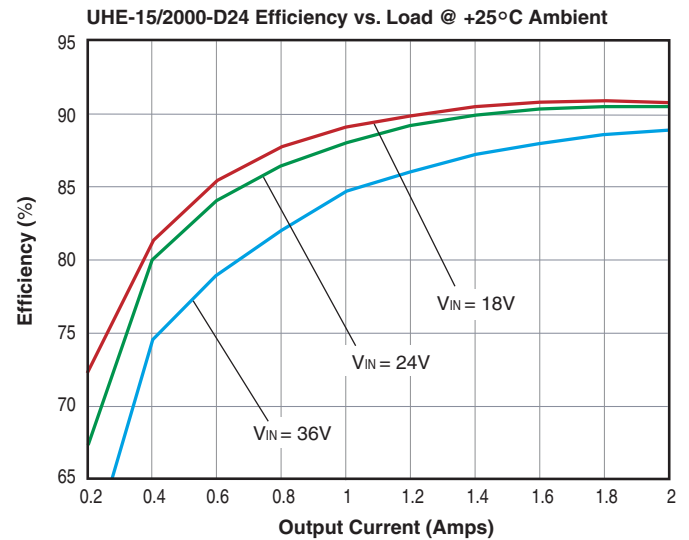
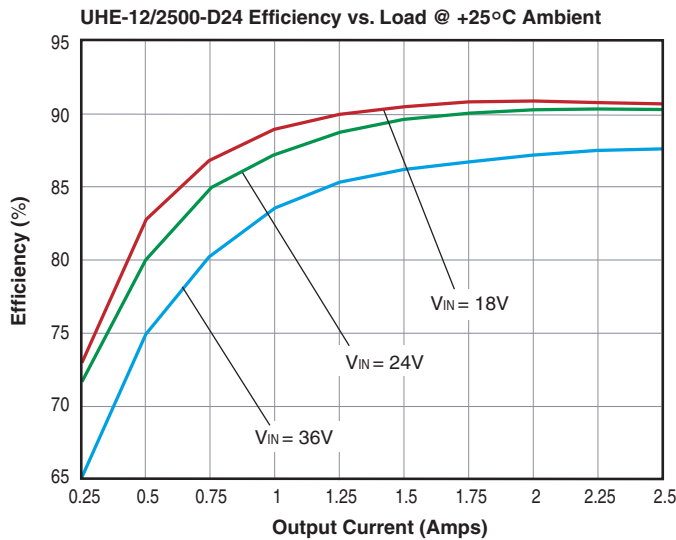
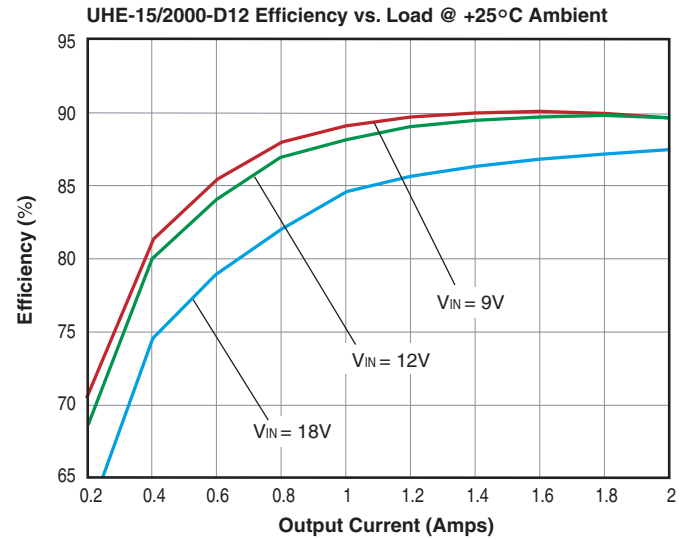
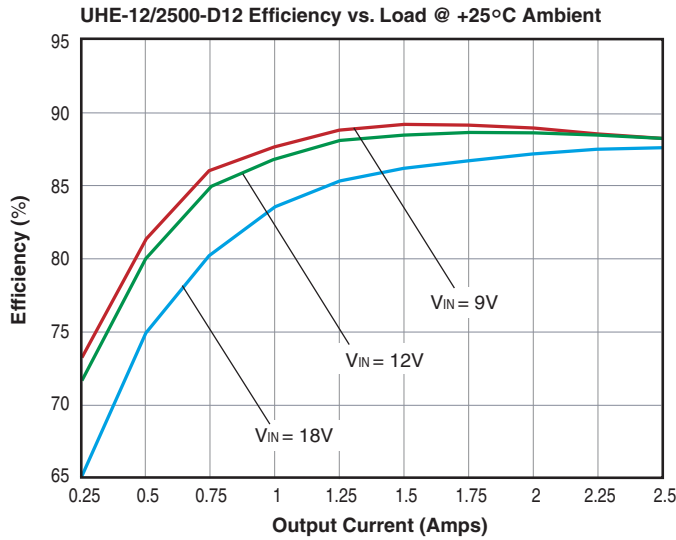

UHE-12-2500-Q48 Efficiency vs. Load @ +25°C Ambient

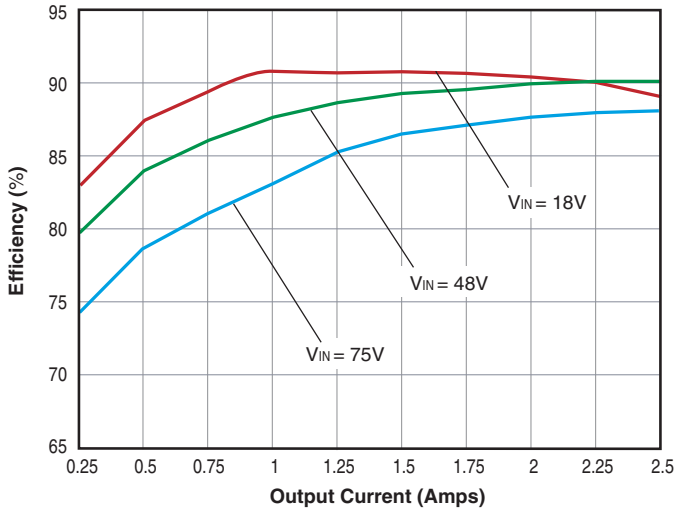

UHE-15-2000-Q48 Efficiency vs. Load @ +25°C Ambient

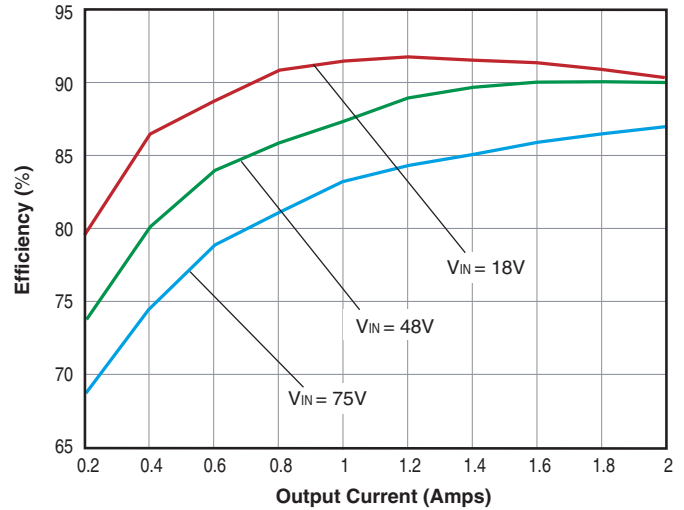

UHE-1.2/10000-D24 and UHE-1.5/10000-D24 Temperature Derating

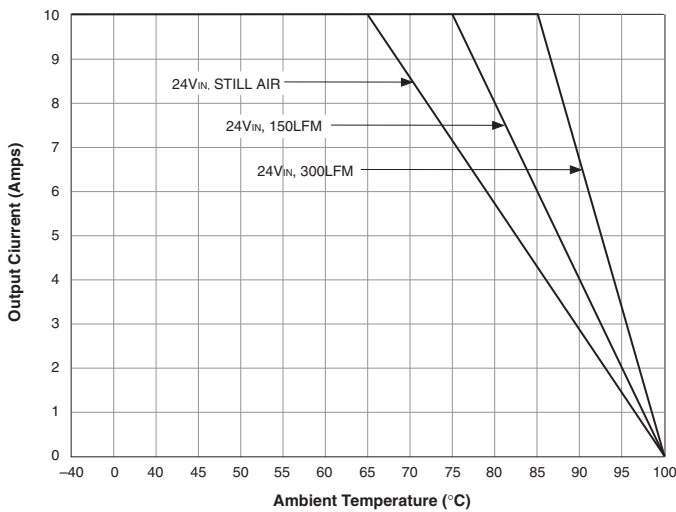

UHE-1.8/10000-D24 Temperature Derating

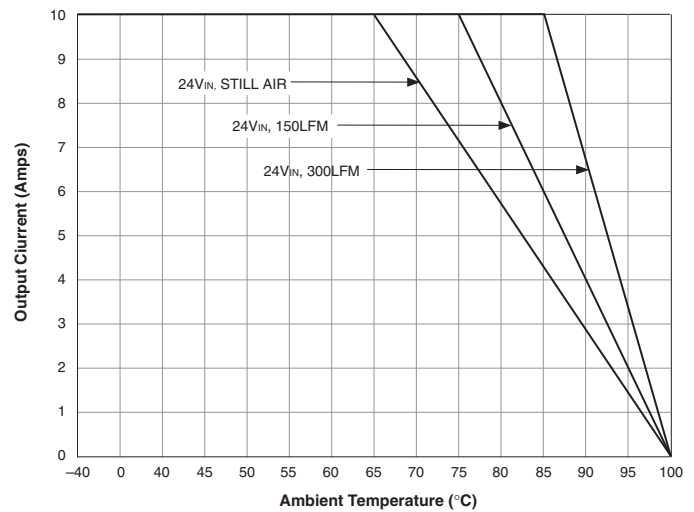

UHE-1.2/10000-D48 and UHE-1.5/10000-D48 Temperature Derating

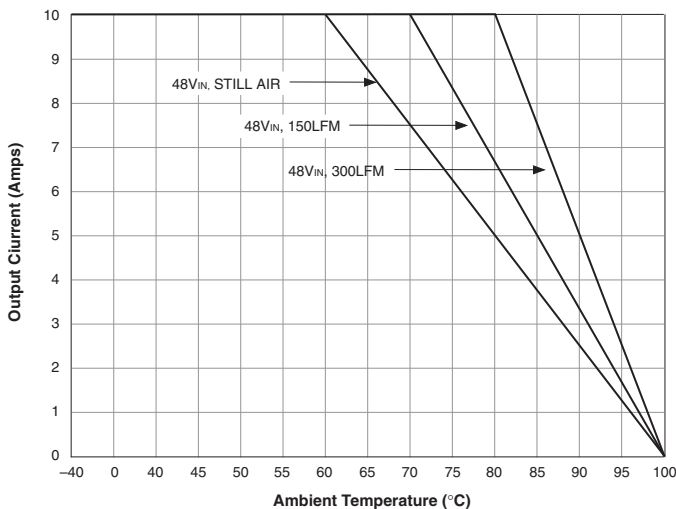

UHE-1.8/10000-D48 Temperature Derating

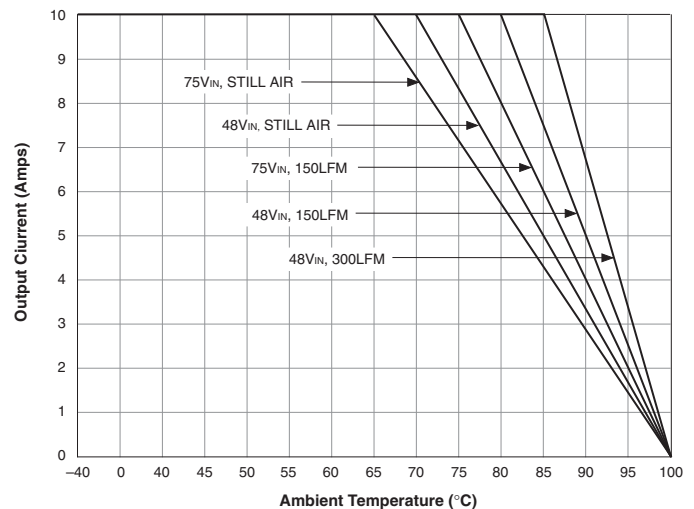

UHE-2.5/10000-D48 Temperature Derating

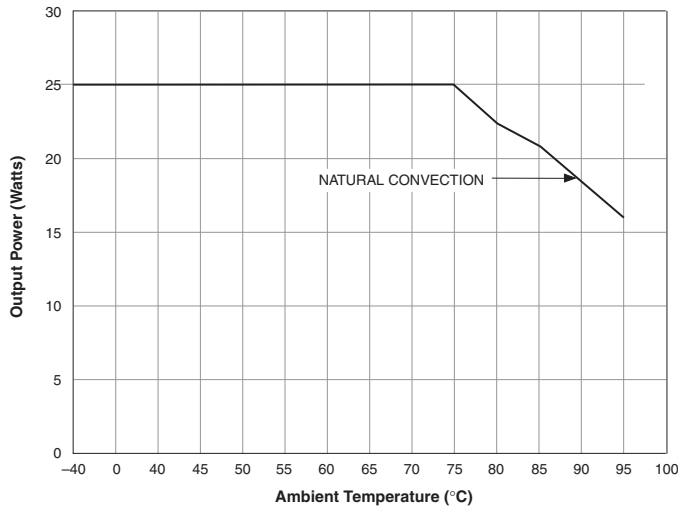

UHE-5/5000-Q12 Temperature Derating

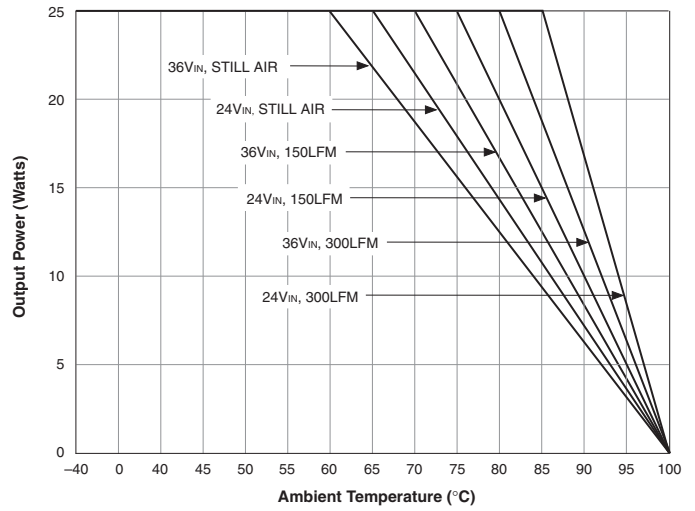

UHE-3.3/7500-Q12 Temperature Derating

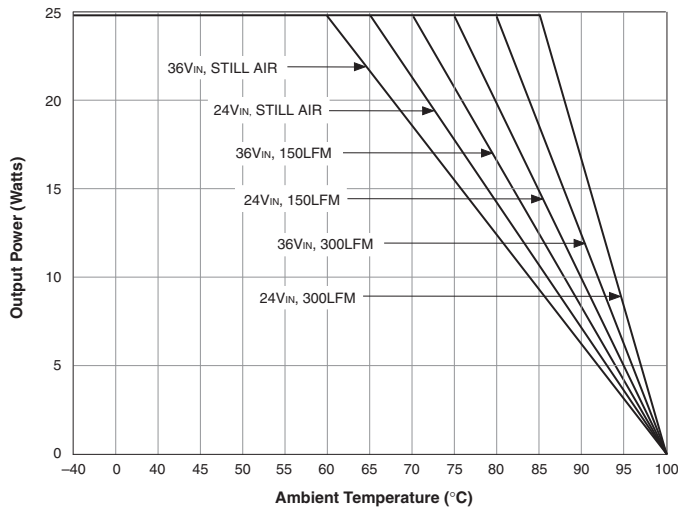

UHE-5/6000-D48 Temperature Derating

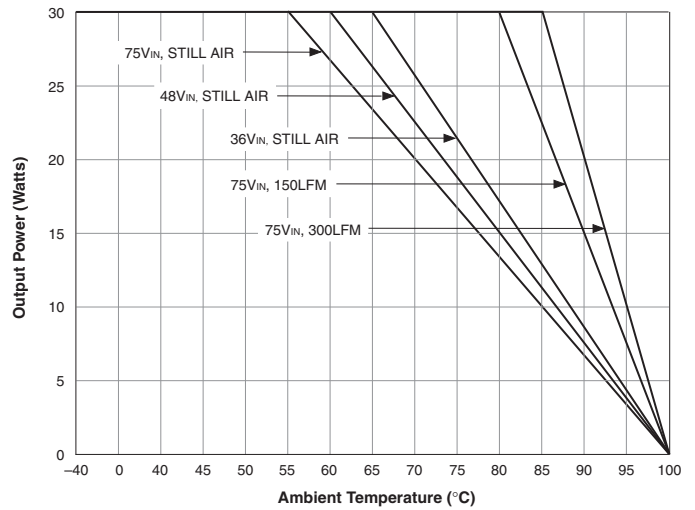

UHE-3.3/7500-D48 Temperature Derating

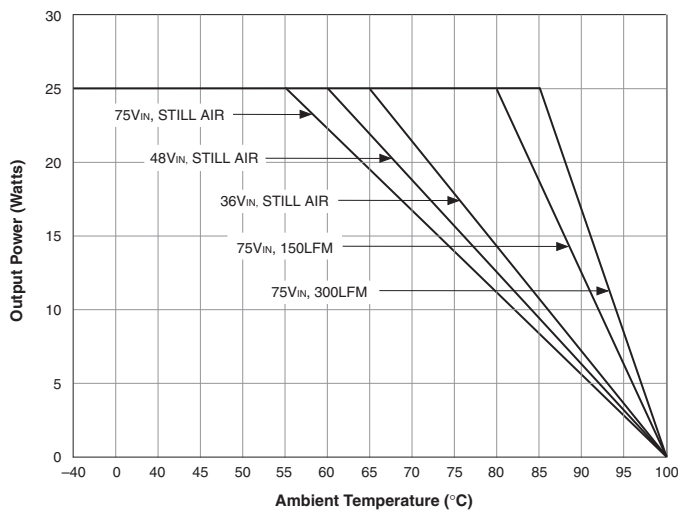

UHE-12/2500 and UHE-15/2000 (All Models) Temperature Derating

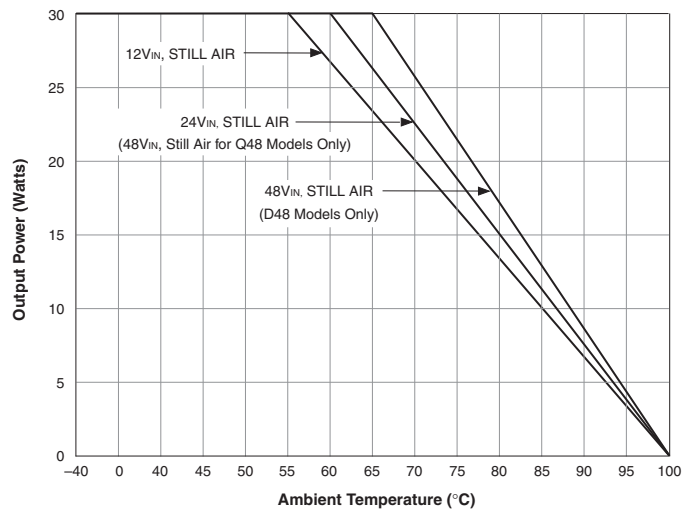

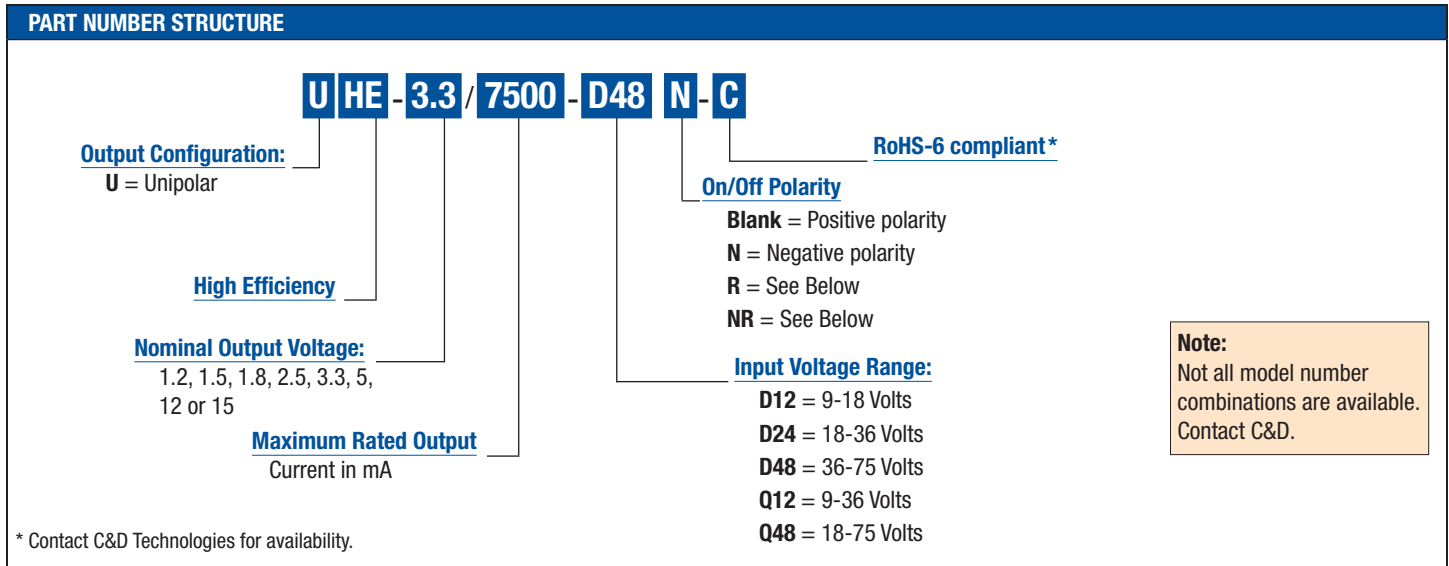

OPTIONS AND ADAPTATIONS

Optional Functions and Part Number Suffixes

The versatile UHE, 12-30W DC/DC converters offer numerous electrical and mechanical options. Per the Ordering Guide on page 2, the trailing DXX or QXX (where XX stands for 12, 24 or 48VIN) in each part number pertains to the base part number. Part-number suffixes are added after this input identification, indicating the selection of standard options. The resulting part number is a "standard product" and is available to any customer desiring that particular combination of options.

The On/Off Control function on pin 4 employs a positive polarity (on = open or "high," no suffix). To request a negative polarity on this pin/function, add an "N" suffix to the part number. Standard models have no pins in the pins 5 and 8 positions. For 5-10A models (1.2-5VOUT), ±Sense pin/functions can be added to these positions (see pinout P52) by adding an "R" suffix. An "NR" suffix can be added for both negative-polarity and sense-pin options. See below.

Suffix Description

- Blank** Positive polarity On/Off Control function (pin 4), VOUT trim (pin 9), no Sense pins, pin length 0.2 inches (5.08 mm).
- N** Add Negative polarity on the On/Off Control function, VOUT trim (pin 9), no Sense pins.
- R** Positive polarity on the On/Off Control function, VOUT trim (pin 9), ±Sense pins in the pin 5 and pin 8 positions (available for low VOUT models only). Available under special order.
- NR** Negative polarity on the On/Off Control function, VOUT trim (pin 9), +/-Sense pins in the pin 5 and pin 8 positions (available for low VOUT models only). Available under special order.

Alternate pin lengths are available under special order

Suffix Description

- T** Alternate trim configuration. Special order only.
- C** Full RoHS-6 compliance (no lead).
- Y** RoHS-5 hazardous substance compliance with lead exception.

Adaptations

There are various additional configurations available on UHE, 12-30W DC/DC's. Because designating each of them with a standard part-number suffix is not always feasible, such are designated by DATEL in assigning a 5-digit "adaptation code" after the part-number suffixes. Once a configuration has been requested by a customer and created by DATEL, the resulting product is available to any customer as a standard off-the-shelf product. Contact DATEL directly if you are interested in your own set of options/adaptations. Our policy for minimum order quantities may apply. Consequently, the following product is offered for sale:

- [UHE-5/6000-D48N-30749](#)
- [UHE-5/6000-D48N-30749-Y \(RoHS-5\)](#)

Standard product, 48VIN, 5V/6A output with negative polarity on the On/Off Control function, modified Trim function (5% trim up = 9.09kΩ, 5% trim down = 3.83kΩ, compatible with UEP-30750), integrated soft start and with input OVP and thermal shutdown removed.

RoHS-5 compliance refers to the exclusion of the six hazardous substances in the RoHS specification with the exception of lead. C&D Technologies' RoHS-5 products use all the conforming RoHS materials, however our solders contain lead. **RoHS-6 compliance** (6 substance) also deletes lead.



C&D Technologies, Inc.

11 Cabot Boulevard, Mansfield, MA 02048-1151 U.S.A.

Tel: (508) 339-3000 (800) 233-2765 Fax: (508) 339-6356

www.cd4power.com email: sales@cdtechno.com

ISO 9001 REGISTERED

DS-0501B 07/24/07

© 2007 C&D Technologies, Inc.

C&D Technologies, Inc. makes no representation that the use of its products in the circuits described herein, or the use of other technical information contained herein, will not infringe upon existing or future patent rights. The descriptions contained herein do not imply the granting of licenses to make, use, or sell equipment constructed in accordance therewith. Specifications are subject to change without notice.

USA: Tucson (Az), Tel: (800) 547 2537, email: sales@cdtechno.com
Canada: Toronto, Tel: (866) 740 1232, email: toronto@cdtechno.com
UK: Milton Keynes, Tel: +44 (0)1908 615232, email: mk@cdtechno.com
France: Montigny Le Bretonneux, Tel: +33 (0)1 34 60 01 01, email: france@cdtechno.com
Germany: München, Tel: +49 (0)89-544334-0, email: ped.munich@cdtechno.com
Japan: Tokyo, Tel: 3-3779-1031, email: sales_tokyo@cdtechno.com
Osaka, Tel: 6-6354-2025, email: sales_osaka@cdtechno.com
Website: www.cd4power.jp
China: Shanghai, Tel: +86 215 027 3678, email: shanghai@cdtechno.com
Guangzhou, Tel: +86 208 221 8066, email: guangzhou@cdtechno.com