

Display, Operate, Switch, Control, Regulate and Communicate



xSystem

Automation products, system solutions and services. The recognised brand name all around the PLC, enhancing the performance of machines and systems.

- PC based HMI-PLC and PLC
- Embedded HMI-PLC
- Modular PLC
- Compact PLC
- HMI
- Remote I/O
- Operator- and control relays**

Product Information

easy500, 700, 800 Control Relays
MFD-Titan® Multi-Function Display

MOELLER



Think future. Switch to green.

Easy Operation With Maximum Benefits



easy control relays provide many basic functions that users could previously only implement with conventional devices that were individually installed and wired. In addition to this, the MFD-Titan multi-function display offers powerful visualization functions as well.

Thanks to the extensive range of the device series you are always sure of finding the right device for your specific requirements. This range extends from the compact stand-alone control relay with a few timing relays and a time switch to large-scale networked applications, processing several hundreds of

I/O with local and remote expansion modules and graphic visualization. The demand for user-friendly operation and programming is consistently met and forms the basis of the outstanding features of easy and MFD-Titan, with particular importance being placed on simple circuit diagram input.

Easy really is easy and, in conjunction with MFD-Titan, offers everything you require from a state-of-the-art automation system: flexible networking, local and remote expansion modules, visualization, scalability, customised inscriptions etc...

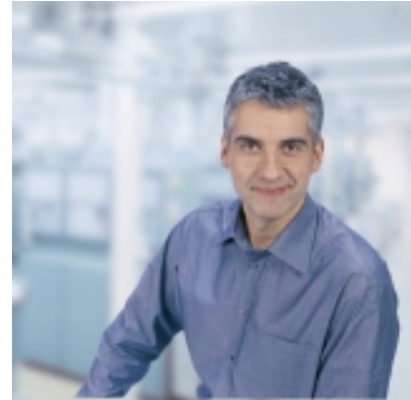

Simplicity as a concept

The easy and MFD-Titan device series stands out with its user-friendly operation and programming, with particular importance being placed on simple circuit diagram input. Every rung or circuit connection is wired in the same way as it was taught in schools and colleges: Contact – Contact – Contact – Coil; Done! The devices allow the “wiring” of 128 or 256 rungs or circuit connections for this purpose. Series and parallel connections, which normally make up the major part of a control circuit, can be created easily without any particular programming knowledge. Ready-to-use function blocks that are simply integrated in the wiring with coils and contacts are also provided for additional functions.

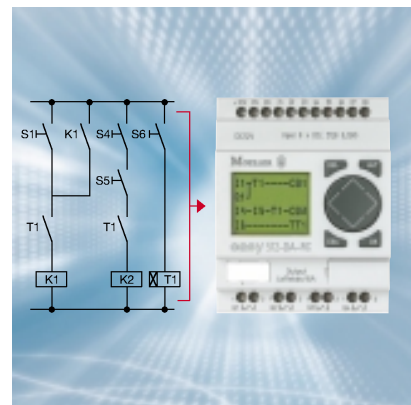

Everything on board

Depending on the device selected, easy and MFD-Titan devices can provide users with timing relays, flash relays, counters, comparators, time switches and many other ready-to-use function blocks, right up to powerful PID controllers. The circuit diagram display of series and parallel connections, unlike the display of AND and OR operations in FBD, offers the user a considerably more manageable display of the circuit. Every easy control relay and MFD-Titan features an integrated power flow display that ensures the safe operation of the circuit diagram during commissioning and helps to identify errors in the circuit diagram initially created. This clearly highlights every energized rung and dims those which are not energized.

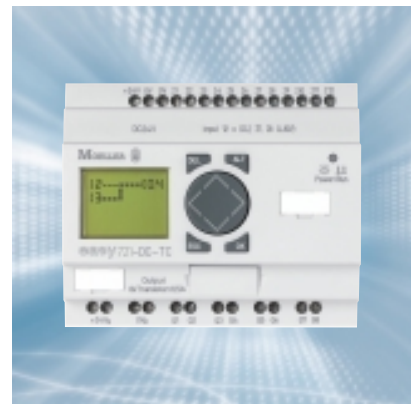

Safety means safety

The finished circuit diagram is stored internally (retentively) and can also be saved externally on a memory module (EEPROM) together with all set parameters, for transport, security and backup. A multi-level password protection secures your circuit diagram against unauthorised viewing, editing, copying or deleting as required. easy or MFD-Titan offer menu-driven interactive operation which can be carried out in ten different languages. The very large operating temperature range from -25 to +55°C for all easy and MFD-Titan control relays means that the devices can be run in a wide range of machines and systems.

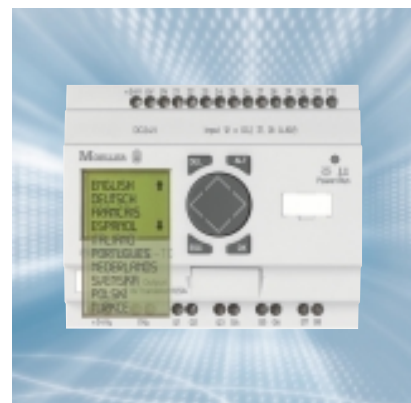





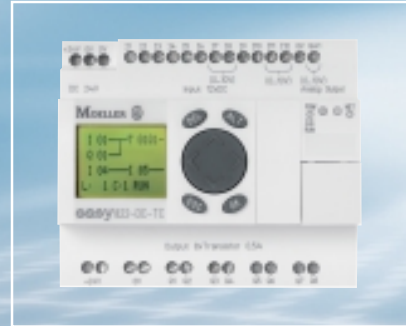
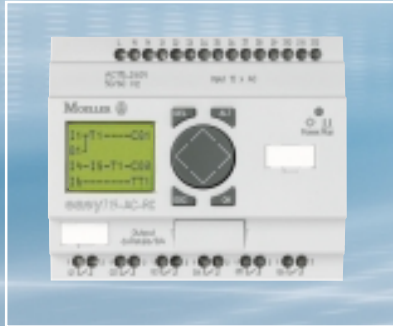

Technical Overview

The Right Device for Every Application











easy500 control relay

For controlling small applications with up to 12 input/output signals

-  • 8 digital inputs
-  • 4 digital relay outputs or optionally
-  • 4 transistor outputs
-  • 128 rungs of 3 contacts and 1 coil each
-  • 16 operating and message texts
-  • 2 analog inputs (10-bit) optional (not with 230 V AC)
-  • 2/2 high-speed inputs, 1 kHz (only DC devices)











easy700 control relay

For controlling medium-sized applications with up to 40 input/output signals

-  • 12 digital inputs
-  • 6 digital relay outputs or optionally
-  • 8 transistor outputs
-  • 128 rungs of 3 contacts and 1 coil each
-  • 16 operating and message texts
-  • 4 analog inputs (10-bit) optional (not with 230 V AC)
-  • 2/2 high-speed inputs, 1 kHz (only DC devices)
-  • 1 digital expansion or network connection

easy800 control relay





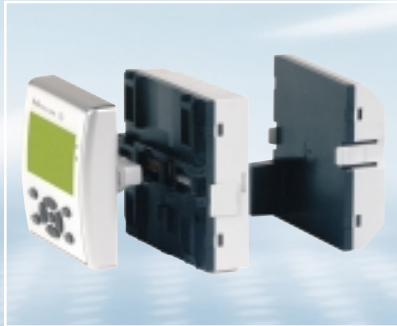





For controlling large-scale applications with up to 300 input/output signals

-  • 12 digital inputs
-  • 6 digital relay outputs or optionally
-  • 8 transistor outputs
-  • 256 rungs of 4 contacts and 1 coil each
-  • 32 operating and message texts
-  • 4 analog inputs (10-bit) optional (not with 230 V AC)
-  • 4 high-speed inputs, 3/5 kHz (only DC devices)
-  • 1 digital expansion or network connection
-  • Networkable via easy-NET with up to 8 stations
-  • 1 analog input (10 bit)



MFD-Titan multi-function display

For controlling large-scale applications with powerful visualization functions

- 
 - 12 digital inputs
- 
 - 4 digital relay outputs or optionally
- 
 - 4 transistor outputs
- 
 - 256 rungs of 4 contacts and 1 coil each
- 
 - 24 KB mask memory on a fully graphical, backlit display (64 x 132 pixels)
- 
 - 4 analog inputs (10-bit) optional (not with 230 V AC)
- 
 - 4 high-speed inputs, 3/5 kHz (only DC devices)
- 
 - 1 digital expansion or network connection
- 
 - Networkable via easy-NET with up to 8 stations
- 
 - 1 analog input (10 bit)

easy800 control relay and MFD-Titan

The easy800 control relay and MFD-Titan combine virtually all the features of a PLC with the user-friendly operating features of the well-known Easy product line. Thanks to their integrated networking capability for up to eight devices, applications with over 300 I/O points can be implemented. The control system can be designed either using a single local program or using several programs on the different distributed devices. Up to 1000 metres can be covered by the network. The control relays can also be integrated easily in higher-level automation networks thanks to the networking modules available (for PROFIBUS DP, CANopen, DeviceNet, AS-Interface).

MFD-Titan multi-function display

The MFD-Titan supports all the functions of the easy800 and also provides a fully graphical display. It replaces 7 segment displays and can indicate fault messages and operating steps graphically or in plain text. The function buttons on the MFD-Titan can be used for displaying and modifying setpoints during operation. High-speed signal counting, frequency measurement, incremental encoder processing can all be implemented with easy800 and MFD-Titan without any problems. Maths functions, data storage or communication via the NET network – all simply easy.

MFD-AC-CP8 and MFD-AC-R16

A new addition to the MFD-Titan family! The MFD-AC-CP8 power supply and CPU modules now also provide users with 230 V AC versions for their applications. As with the already known 24 V DC version, a power supply/CPU module is available without easy-NET (MFD-AC-CP8-ME) and with easy-NET (MFD-AC-CP8-NT). If users also require 230 V AC inputs for their MFD-Titan applications, Moeller can now offer the MFD-AC-R16 I/O module in combination with the two MFD-AC-CP8 power supply/CPU modules. This therefore provides 12 inputs and 4 relay outputs.

easy-NET Communication Made easy



The easy800 control relay and the MFD-Titan® can be networked simply and inexpensively.

This is made possible thanks to the integrated easy-NET network, which allows up to eight stations, consisting of easy800 or MFD-Titan devices, to communicate with each other over a distance of up to 1000 metres. Whether the devices involved are running their own programs or are only used as remote input/output modules is of no importance.

Furthermore, all stations can be expanded locally using the easy Link interface. This enables easy control relays and MFD-Titan devices to be used seamlessly in automation applications involving 12 to over 300 I/O points. The MFD-Titan also features the

possibility of a simple point-to-point connection with an easy800 or another MFD-Titan via the serial interface.

Communication modules allow the device to be connected to AS-Interface, PROFIBUS-DP, CANopen and DeviceNet bus systems.

The MFD-Titan is used as a display, operating, programming and parameter device.

The operator can observe the entire network via the PC. In this case, the PC can be connected to any station using the serial programming interface.



Universal Fieldbus Modules easy in Automation Interaction

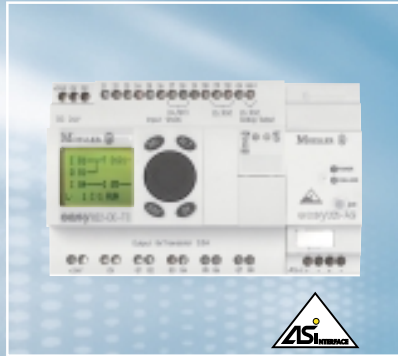

1200 metres. The EASY204-DP bus gateway makes easy control relays even more flexible and powerful, since entire parameter sets of easy can be read or exchanged via this bus connection. If, for example, other recipes require different parameter sets to be transferred to easy, these times, clock times, counter states, setpoints and actual values can be controlled by a suitable bus master on this powerful fieldbus system.

Connection to world standard fieldbus systems

As described in the previous section "Transferring complex data", the EASY221-CO bus coupler for CANopen and EASY222-DN for DeviceNet likewise offer the same functions.

With a fieldbus connection to the production process

Commanding, signalling, monitoring and controlling on bit level

A bus connection is worthwhile even for simple operating steps as found in production processes. The Actuator-Sensor Interface, or AS-i for short, can provide 31 slaves simultaneously with 248 binary data items. For machine building applications, AS-i is definitely the right bus connection, since input/output data can be transferred with particularly fast reaction times of only 5 ms. This makes it possible, for example, to start up several motors simultaneously in a materials handling application.

The EASY205-ASI communication module makes this bus connection particularly easy. It can be connected

centrally via easy-Link to all expandable easy basic units, i.e. the easy700 and easy800 series as well as MFD-Titan. The two-wire AS-i cable is simply wired up to the module – that's it! Data exchange is then organised via a higher-level AS-i master.

Transferring complex data

More powerful fieldbus systems such as Profibus-DP are used for complex automation tasks involving the transport of large data sets, such as several analog values, setpoints, counter states or time parameters. With Profibus-DP up to 20 bytes of data per station can be transferred with each bus cycle, and up to 126 bus stations can be linked together over a distance of up to

Easy offers us the flexibility we need. The expansions can be ideally adapted to the task at hand, so that you never have to pay for more than you need.



“Stand-Alone” easy Display with High Degree of Protection



easy product series now with stand-alone display to IP65

With the new MFD-CP4-500 / MFD-CP4-800 supply and communication module, Moeller is offering a stand-alone display with IP65 protection for all easy500/700 and easy800 applications.

1 2a Plug & work

The plug & play technology allows users to connect the MFD-Titan display (MFD-80 or MFD-80-B) to the easy control relay via the MFD-CP4 supply and communication module. With this in mind, the MFD-CP4 module is factory shipped with five metres of serial connection cable that can be cut to any required length, thus allowing the display to be run up to five metres away from the control relay.

The benefits of this are multiple. No software or drivers are needed for the connection since MFD-CP4 is a genuine plug & play device. The I/O wiring can be kept in the control panel, and mounting the display is also easy thanks to the 2 x 22.5 mm fixing holes provided. The display is protected to IP65, comes with a backlight and offers optimum legibility.

Two versions are available for the easy control relays: MFD-CP4-500 is used with all easy500/700s, MFD-CP4-800 with all easy800 and MFD-CP8 devices.

1 2b 3 MFD-Titan the HMI-Control

When fitted with a power supply/CPU module and optional input/output modules, the display can also be expanded into a compact HMI control device that then combines the complete functionality of an easy800 with powerful visualization functions. The two modules are simply plugged together. Plug & work



1



2a



2b

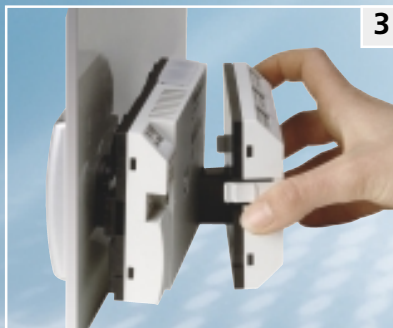

3

More Input/Output Signals Central and Decentralised Expansion Made easy



1

The expandable basic units of the easy700, easy800 series and MFD-Titan® enable central and decentralised I/O expansions to be implemented.

- 1 Together with the EASY618-AC-RE, EASY618-DC-RE or EASY620-DC-TE expansion modules, you can form a unit with 24 inputs and up to 16 outputs. These three expansion modules are simply fitted onto the basic unit directly and connected via the easy Link interface.
- 2 Alternatively, a connection can be set up using the EASY200-EASY coupling module and up to 30 metres of two-wire cable, enabling also extensive or expanded configurations to be set up.
- 3 If that isn't enough, the EASY202-RE expansion module provides two additional relay outputs.



1



2



3

Labeleditor The New Flexibility



Simple and Customised Inscription

Moeller's new Labeleditor offers customers the ideal solution for laser inscribing symbols, company logos, text or graphics, individual characters, Asian, Cyrillic, Greek or Roman letters on a device, even in combination.

The new Labeleditor inscription software guides users directly through their labelling task in the program. Moeller can then laser inscribe the device exactly to customer requirements.

Whether the customised inscription is for the RMQ-Titan control circuit device (22.5 mm range), the MFD-Titan multi-function display or the easy control relay, customers simply use the Labeleditor to create their inscription file and send it with a few clicks of the mouse.

The software shows directly on screen exactly how the laser inscription will look on the device in question.

The software includes well over 400 symbols, for example, for emergency-stop marking, jog mode, klaxon, clamp, release, and many others in several languages.

Moeller enables us to inscribe our own markings on the operator units. The devices are already cleanly and perfectly inscribed on delivery without us having to do the work.

Basic Units

Overview and Selection



EASY512-AC-RC



EASY512-DC-TCX



EASY512-DC-RC

Basic units	500 basic units									
Application	Stand-alone operation									
Type Order No.	EASY512-AB-RC Z7A101	EASY512-AB-RCX Z7A102	EASY512-AC-R Z7A103	EASY512-AC-RC Z7A104	EASY512-AC-RCX Z7A105	EASY512-DA-RC Z7A106	EASY512-DA-RCX Z7A107	EASY512-DC-R Z7A108	EASY512-DC-RC Z7A109	EASY512-DC-RCX Z7A110
Supply voltage	24 V AC			100 - 240 V AC			12 V DC			
Heat dissipation	5 VA			5 VA			2 W			
Inputs, digital	8	8	8	8	8	8	8	8	8	
Inputs, analog 0 - 10 V (optional)	2	2	-	-	-	2	2	2	2	
Outputs, digital (R=relay,T=trans.)	4R	4R	4R	4R	4R	4R	4R	4R	4R	
Outputs, analog 0 - 10 V	-	-	-	-	-	-	-	-	-	
LCD display / keypad	Yes / Yes	- / -	Yes / Yes	Yes / Yes	- / -	Yes / Yes	- / -	Yes / Yes	Yes / Yes	
7-day / year time switch	Yes / Yes	Yes / Yes	- / -	Yes / Yes	Yes / Yes	Yes / Yes	Yes / Yes	Yes / Yes	- / -	
Continuous current outputs [1]	8 A	8 A	8 A	8 A	8 A	8 A	8 A	8 A	8 A	
Short-circuit proof with power factor 1	Line protection B16, 600 A									
Short-circuit proof with power factor 0.7... 0.7	Line protection B16, 900 A									
Connection cables	0.2 - 4.0 mm ² (AWG 22-12), solid 0.2 - 2.5 mm ² (AWG 22-12), flexible									
Degree of protection	IP 20									
RFI suppression	EN 55011, EN 55022 Class B, IEC 61000-6-1, 2, 3, 4									
Ambient operating temperature	- 25 °C ... + 55 °C									
Transport and storage temperature	- 40 °C ... + 70 °C									
Certification, standards	EN 50178, IEC/EN 60947, UL, CSA									
Mounting	On top-hat rail to DIN 50022, 35 mm or screw mounting with ZB4-101-GF1 fixing brackets									
Dimensions (W x H x D) mm	71.5 x 90 x 58 mm									

[1] Relay = 8 A (10 A to UL) with resistive load, 3 A with inductive load/transistor outputs = 0.5 A / 24 V DC, max 4 outputs switchable in parallel

[2] With backlight in continuous operation - 10 °C ... 0 °C

[3] In stand-alone operation the MFD...CP8... CPU slices can also be mounted on a DIN 50022 top-hat rail, 35 mm or as screw mounting with ZB4-101-GF1 fixing brackets



12-DA-RC



EASY719-AC-RCX



EASY721-DC-TC



EASY819-AC-RC

700 basic units												
Expandable (EASY2... , EASY6...)												
EASY512-DC-RC 2741109	EASY512-DC-RCX 2741110	EASY512-DC-TC 2741111	EASY512-DC-TCX 2741112	EASY719-AB-RC 2741113	EASY719-AB-RCX 2741114	EASY719-AC-RC 2741115	EASY719-AC-RCX 2741116	EASY719-DA-RC 2741117	EASY719-DA-RCX 2741118	EASY719-DC-RC 2741119	EASY719-DC-RCX 2741120	EASY721-DC-TC 2741121
24 V DC				24 V AC		100 - 240 V AC		12 V DC		24 V DC		
2 W				7 VA		10 VA		3.5 W		3.5 W		
8	8	8	8	12	12	12	12	12	12	12	12	12
2	2	2	2	4	4	-	-	4	4	4	4	4
4R	4R	4T	4T	6R	6R	6R	6R	6R	6R	6R	6R	8T
-	-	-	-	-	-	-	-	-	-	-	-	-
Yes / Yes	- / -	Yes / Yes	- / -	Yes / Yes	- / -	Yes / Yes	- / -	Yes / Yes	- / -	Yes / Yes	- / -	Yes / Yes
Yes / Yes	Yes / Yes	Yes / Yes	Yes / Yes	Yes / Yes	Yes / Yes	Yes / Yes	Yes / Yes	Yes / Yes	Yes / Yes	Yes / Yes	Yes / Yes	Yes / Yes
8 A	8 A	0.5 A	0.5 A	8 A	8 A	8 A	8 A	8 A	8 A	8 A	8 A	0.5 A
		-	-	Line protection B16, 600 A								-
		-	-	Line protection B16, 900 A								-
0.2 - 4.0 mm ² (AWG 22-12), solid 0.2 - 2.5 mm ² (AWG 22-12), flexible												
IP 20												
EN 55011, EN 55022 Class B, IEC 61000-6-1, 2, 3, 4												
-25 °C ... +55 °C												
-40 °C ... +70 °C												
EN 50178, IEC/EN 60947, UL, CSA												
On top-hat rail to DIN 50022, 35 mm or screw mounting with ZB4-101-GF1 fixing brackets												
107.5 x 90 x 58 mm												



EASY822-DC-TC

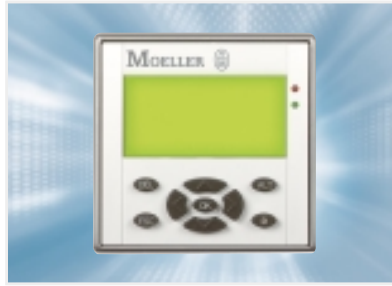

MFD-80-B



MFD-CP4

800 basic units												MFD-Titan	
Expandable (EASY2... , EASY6...), networkable (easy-NET)												Display	
EASY721-DC-TCX 274122	EASY819-AC-RXC 256267	EASY819-AC-RCX 256268	EASY819-DC-RXC 256269	EASY819-DC-RCX 256270	EASY820-DC-RXC 256271	EASY820-DC-RCX 256272	EASY821-DC-TC 256273	EASY821-DC-TCX 256274	EASY822-DC-TC 256275	EASY822-DC-TCX 256276	MFD-80 265230	MFD-CP4	
100 - 240 V AC			24 V DC									Supply via ...	
10 VA			3.4 W									3 W	
12	12	12	12	12	12	12	12	12	12	12	-	-	
4	-	-	4	4	4	4	4	4	4	4	-	-	
8T	6R	6R	6R	6R	6R	6R	8T	8T	8T	8T	-	-	
-	-	-	-	-	1	1	-	-	1	1	-	-	
- / -	Yes / Yes	- / -	Yes / Yes	- / -	Yes / Yes	- / -	Yes / Yes	- / -	Yes / Yes	- / -	Yes / -	Yes / -	
Yes / Yes	Yes / Yes	Yes / Yes	Yes / Yes	Yes / Yes	Yes / Yes	Yes / Yes	Yes / Yes	Yes / Yes	Yes / Yes	Yes / Yes	- / -	- / -	
0.5 A	8 A	8 A	8 A	8 A	8 A	8 A	0.5 A	0.5 A	0.5 A	0.5 A	-	-	
-	Line protection B16, 600 A						-	-	-	-	-	-	
-	Line protection B16, 900 A						-	-	-	-	-	-	
0.2 - 4.0 mm ² (AWG 22-12), solid 0.2 - 2.5 mm ² (AWG 22-12), flexible												-	-
IP 20												IP 65	
EN 55011, EN 55022 Class B, IEC 61000-6-1, 2, 3, 4													
- 25 °C ... + 55 °C												Clearly legible - 5 °C ... + 50 °C	
- 40 °C ... + 70 °C													
EN 50178, IEC/EN 60947, UL, CSA													
On top-hat rail to DIN 50022, 35 mm or screw mounting with ZB4-101-GF1 fixing brackets												Front mounting 22.5 mm standard c	
107.5 x 90 x 72 mm												86.5 x 86,5 x 20	



MFD-CP8-NT



MFD-R16



MFD-TA17

	Power supply / Coupling		Power supply / CPU				Inputs / outputs				
	MFD-CP4-500 274094	MFD-CP4-800 274095	MFD-CP8-ME 267164	MFD-CP8-NT 265233	MFD-AC-CP8-ME 274091	MFD-AC-CP8-NT 274092	MFD-AC-R16 274093	MFD-R16 265254	MFD-RA17 265364	MFD-T16 265255	MFD-TA17 265256
CP...	24 V DC			100 - 240 V AC			Supply via ...-CP8-...				
	1.5 W		3 W		8 VA		0.5 W				
-	-	-	-	-	-	-	12	12	12	12	12
-	-	-	-	-	-	-	-	4	4	4	4
-	-	-	-	-	-	-	4R	4R	4R	4T	4T
-	-	-	-	-	-	-	-	-	1	-	1
es / Yes	- / -	- / -	- / -	- / -	- / -	- / -	- / -	- / -	- / -	- / -	- / -
- / -	- / -	- / -	Yes / Yes	Yes / Yes	Yes / Yes	Yes / Yes	- / -	- / -	- / -	- / -	- / -
-	-	-	-	-	-	-	8 A	8 A	8 A	0.5 A	0.5 A
-	-	-	-	-	-	-	Line protection B16, 600 A			-	-
-	-	-	-	-	-	-	Line protection B16, 900 A			-	-
-	0.2 - 4.0 mm ² (AWG 22-12), solid 0.2 - 2.5 mm ² (AWG 22-12), flexible										
	IP 20										
	EN 55011, EN 55022 Class B, IEC 61000-6-1, 2, 3, 4										
at [2]	- 25 °C ... + 55 °C										
	- 40 °C ... + 70 °C										
	EN 50178, IEC/EN 60947, UL, CSA										
in 2 x drill holes	n/a [3] (snap fitted on MFD-80...)					n/a (snap fitted on MFD-...CP8-...)					
mm	78 x 58 x 36.2 mm		107.5 x 90 x 29.5 mm				88.1 x 90 x 25 mm				

EASY-SOFT

The User-Friendly Circuit Diagram Input

EASY-SOFT makes things particularly easy for users. The graphical editor shows the circuit diagram immediately in the display format required. Selection menus and drag & drop functions simplify circuit diagram creation. Simply select contacts and coils and connect with the mouse – that's it!

In addition to the editing functions available for the user on the devices themselves, the scaled software packages EASY-SOFT-BASIC, EASY-SOFT and EASY-SOFT-PRO are available for straightforward circuit diagram input.

The user-friendly menus and Help screens of EASY-SOFT can be called up in six different languages.

EASY-SOFT offers the following display formats for viewing, editing and printing out your program:

- IEC format with contact and coil symbols of the international standard
- easy circuit diagram, a 1:1 representation of the display in easy
- ANSI format, in compliance with the American standard

EASY-SOFT supports you in configuring, programming and defining parameters for easy control relays, and in creating visualization functions for the MFD-Titan. If control relays are connected to easy-NET, all connected devices can be accessed and their programs loaded from a single control relay.

The integrated offline simulation tool allows the user to test the correct functioning of the circuit diagram before commissioning, without the need for a connected device. The comment function for contacts, coils and function blocks helps to provide a

clear overview of the circuit diagram. A cover sheet with a customised company logo and different text fields, as well as the cross-reference list with comments, can turn printouts into the perfect documentation for your application.

easy is maintenance-free

The finished program is stored for ever in easy's non-volatile memory or until it is modified. Additional auxiliary power or a battery are not required. The control relays are thus entirely maintenance-free.

Not only circuit diagrams and parameters are saved in the event of a power failure. easy also makes a note of switch positions or values. For example, the actual values of operating hours meters, counters and timing relays can be processed further once power is restored. The retentive function for the different function blocks and data is available with all performance classes of the easy series.

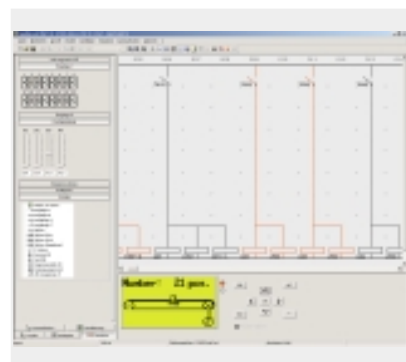
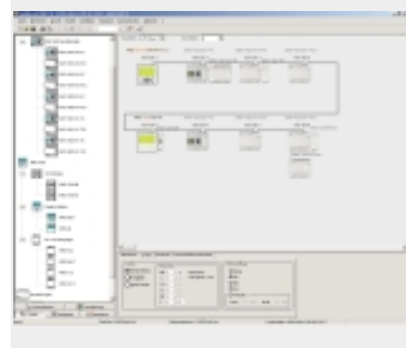

Accessories

Overview and Selection



EASY618-DC-RE

EASY202-RE



EASY204-DP

EASY200-EASY

Accessories	Expansion modules				Expansion modules	
Application	Digital inputs / outputs				Communication	
Type Order No.	EASY202-RE 232186	EASY618-AC-RE 212314	EASY618-DC-RE 232112	EASY620-DC-TE 212313	EASY200-EASY 212315	EASY204-DP 212316
Supply voltage	-	100 - 240 V AC	24 V DC		-	24 V AC
Heat dissipation	1 W	10 VA	4 W		1 W	2 W
Inputs, digital	-	12	12	12	-	-
Inputs, analog 0 - 10 V (optional)	-	-	-	-	-	-
Outputs, digital (R=relay,T=trans.)	2R	6R	6R	8T	-	-
Outputs, analog 0 - 10 V	-	-	-	-	-	-
LCD display / keypad	-/-	-/-	-/-	-/-	-/-	-
7-day / year time switch	-/-	-/-	-/-	-/-	-/-	-
Continuous current outputs [1]	8 A	8 A	8 A	0.5 A	-	-
Short-circuit proof with power factor 1	Line protection B16, 600 A			-	-	-
Short-circuit proof with power factor 0.7... 0.7	Line protection B16, 900 A			-	-	-
Connection cables	0.2 - 4.0 mm ² (AWG 22-12), solid 0.2 - 2.5 mm ² (AWG 22-12), flexible				0.2 - 4.0 mm ² (AWG 22-12), solid 0.2 - 2.5 mm ² (AWG 22-12), flexible	
Degree of protection	IP 20				IP 20	
RFI suppression	EN 55011, EN 55022 Class B, IEC 61000-6-1, 2, 3, 4				EN 55011, EN 55022 Class B, IEC 61000-6-1, 2, 3, 4	
Ambient operating temperature	- 25 °C ... + 55 °C				- 25 °C ... + 55 °C	
Transport and storage temperature	- 40 °C ... + 70 °C				- 40 °C ... + 70 °C	
Certification, standards	EN 50178, IEC/EN 60947, UL, CSA				EN 50178, IEC/EN 60947, UL, CSA	
Mounting	On top-hat rail to DIN 50022, 35 mm or screw mounting with ZB4-101-GF1 fixing brackets				On top-hat rail to DIN 50022, 35 mm or screw mounting with ZB4-101-GF1 fixing brackets	
Dimensions (W x H x D) mm	35.5 x 90 x 58 mm	107.5 x 90 x 58 mm			107.5 x 90 x 58 mm	

[1] Relay = 8 A (10 A to UL) with resistive load, 3 A with inductive load/transistor outputs = 0.5 A / 24 V DC, max 4 outputs switchable in parallel



205-ASI EASY221-CO EASY222-DN

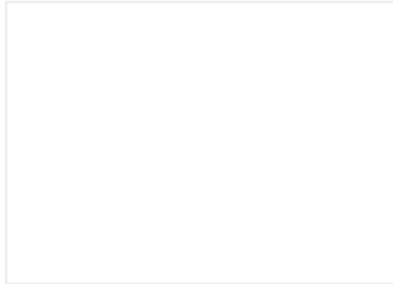

EASY200-POW EASY400-POW

EASY205-ASI 221598	EASY221-CO 233539	EASY222-DN 233540
-	24 V AC	24 V AC
1 W	1 W	1 W
-	-	-
-	-	-
-	-	-
-	-	-
-	-	-
-	-	-
-	-	-
-	-	-
-	-	-
1.0 mm ² (AWG 22-12), solid 5 mm ² (AWG 22-12), flexible		
IP 20		
55022 Class B, IEC 61000-6-1, 2, 3, 4		
- 25 °C ... + 55 °C		
- 40 °C ... + 70 °C		
178, IEC/EN 60947, UL, CSA		
hat rail to DIN 50022, 35 mm ing with ZB4-101-GF1 fixing brackets		
35.5 x 90 x 58 mm		

Accessories	Switched-mode power supply units	
Application		
	EASY200-POW 229424	EASY400-POW 212319
Supply voltage	100 - 240 V AC	
Maximum range	85 - 264 V AC	
Output voltage	24 V DC (+/- 3%)	
Output current (rated value)	0.25 A	1.25 A
Overcurrent limitation from	0.3 A	1.4 A
Short-circuit proof (secondary)	Yes	Yes
Overload proof	Yes	Yes
Potential isolation (prim./sec.)	Yes, SELV (to EN 600950, VDE 805)	
Others	Additional output voltage 12 DC, 20 mA	-
Connection cables	0.2 - 4.0 mm ² (AWG 22-12), solid 0.2 - 2.5 mm ² (AWG 22-12), flexible	
Degree of protection	IP 20	
RFI suppression	EN 55011, EN 55022 Class B, IEC 61000- 6-1, 2, 3, 4	
Ambient operating temperature	- 25 °C ... + 55 °C	
Transport and storage temperature	- 40 °C ... + 70 °C	
Certification, standards	EN 50178, IEC/EN 60947, UL, CSA	
Mounting	On top-hat rail to DIN 50022, 35 mm or screw mounting with ZB4-101-GF1 fixing brackets	
Dimensions (W x H x D) mm	35.5 x 90 x 58 mm	71.5 x 90 x 58 mm

easy in Application



EASY 800: high pressure cleaning and renovating

Falch Hochdruckstrahlssysteme GmbH is a company based in Merklingen in Southwest Germany. With approximately 65 employees, the company produces high pressure washers for working pressures from 100 to 2000 bar. Its latest system, the TS20, operates with a water jet speed of over 2100 km/h and a pressure of up to 2000 bar, with an operating weight of nearly 1800 kg. These mobile high pressure jet systems are primarily used for cleaning and renovating. State-of-the-art control technology is used for controlling and monitoring the desired working pressure and provides up-to-date status information about the system. Falch carries out the development, engineering and assembly of the systems on its own. Service-friendly designs and a worldwide service are just as fundamental a requirement at Falch as an extensive range of system accessories.

Easy 820 controls the working pressure of mobile high pressure washers

Water jets offer an economical and environmentally-friendly alternative. Water jet cleaning using Falch's high-pressure technology is used wherever new application fields are involved, in which the cutting performance of conventional machines is insufficient or where the performance in manual

operation is uneconomical. It is primarily used for cleaning and renovating.

Cleaning

- Paint removal from metals,
- Rust removal from steel surfaces without the use of blasting agents,
- Industrial cleaning, such as the cleaning of tanks and tubes.

Renovating

- Fast and careful removal of old paint coatings on concrete
- Cleaning of concrete surfaces,
- Concrete removal, such as for bridge renovations,
- Concrete refurbishment, such as for exposing steel reinforcements.

The tasks listed can all be carried out with water jets in an environmentally-friendly and economical way. Furthermore, this is possible without any auxiliary media and chemical additives as is otherwise required with other processes.

The working pressure required varies between 100 or 2000 bar, depending on the application at hand. The working pressure and flow rate are proportional to the speed of the high pressure pump, which is driven by a diesel engine. The 400 litre water tank integrated in the TS20 makes it possible to treat test surfaces without the connection of an external water or power source.

The pump speed is controlled by Moeller's EASY820-DC-RC control relay with an EASY720-DC-TE expansion unit. The required working pressure can be set directly on the device via the integrated operator and display elements. From the preset value and available parameters the control relay calculates the speed setpoint for the control device of the diesel engine. The actual pressure value is measured in the high pressure section of the system and is fed back to the control relay for controlling the speed. All the signals are analog 0...10 V signals. The control relay likewise monitors limit values such as maximum and minimum pressure and switches off the system if necessary with the appropriate error message. The text display integrated in the control relay provides the user with information about the set and actual pressure, the flow rate per minute, the current engine speed, which is measured via high-speed counter inputs, and the operating hours of the systems. The program section also monitors the switching elements of the high pressure pistol and evaluates the relevant monitoring signals of the motor control device. If an error is detected in the activation of the high pressure pistol, such as a cable break, an earth fault or short-circuit, or if it detects one in the motor control, it automatically switches off the system with the appropriate error message. This increases operational safety and reduces downtimes. An additional frost protection program is provided to protect the pump section from damage caused by freezing.



MFD-Titan® in Application

New operating and control concept for textile machines with MFD-Titan

The continuous pressure to develop innovative products and reduce prices, together with increased demands with regard to machine operation and control are causing textile machines manufacturers to seek out new ideas. Maschinenfabrik Herbert Meyer, one of the largest manufacturers of textile machines, is taking up these challenges with Moeller's new MFD-Titan multi-function display.

The MFD-Titan is a device for the new generation of automation devices that combines control and visualization functions in one device. It only requires one software for the control functions, the visualization and the networking, thus considerably reducing the time required for engineering and programming.

To meet customers requirements for the operation and control of the new generation of fusing machines, Maschinenfabrik Herbert Meyer chose Moeller's MFD-Titan multi-function display. The full-featured graphic display and a customised user interface ensure a high level of user-friendliness in operating the machine. Other requirements that could be met included four closed-loop controllers for two temperature control systems, a pressure and speed control, as well as the activation of a frequency inverter. The MFD-Titan can not only meet these requirements entirely but can also provide special closed-loop control functions, such as pulse width modulation for regulating heater circuits.

Customised inscription

The MFD-Titan can also be provided with customised inscriptions on the outside of the HMI as required. This not only allows a machine manufacturer to inscribe a distinctive logo, but also specific markings for clear operator guidance. In addition to company markings or other identification features, the integrated keypad and the two status LEDs can be customised for every device.

User-friendly visualization

The visualization functions allow users to create their own masks with a wide range of MFD tools and display elements which can be assigned different attributes. Elements are available for static texts, message texts, graphics, numerical value or date displays in different formats, as well as value entries or bit displays. The variable attributes of an element can be set as visible, invisible, flashing, static and also inverse display. The text management function supports multi-lingual visualization.

For

this, the mask overview allows you to enter or select texts for several languages, including static texts and message texts.

This type of language management is the hallmark of a mature visualization system. The functions provided by the button editor and mask control also reduce the configuration requirements for the automation, since visualization and control are implemented on the same hardware and software platform. All the variables of the control device are thus directly available for the visualization and can be used for controlling the display elements, for outputs and data inputs. Value entries are not made via the integrated control device but via configuration windows for entering step widths and other data entry attributes and value displays.

Parameter definition not programming

An "easy" control device, called easy-inside, is integrated in the MFD-Titan multi-function display. The core of this is an easy800 with an extended range of function blocks such as PID controllers, signal smoothing filters, pulse width modulation and many more. The processor allows 32-bit operations, and the cycle time can be set to fixed values between 1 and 1000 ms or via the software. A number of variables can be used as cycle time setpoints.

This enables machine builders to implement a wide range of solutions for complex closed-loop control tasks.



easy and MFD-Titan[®] in Application

Profiling system

for manufacturing timber profiles and boards thanks to **easy**

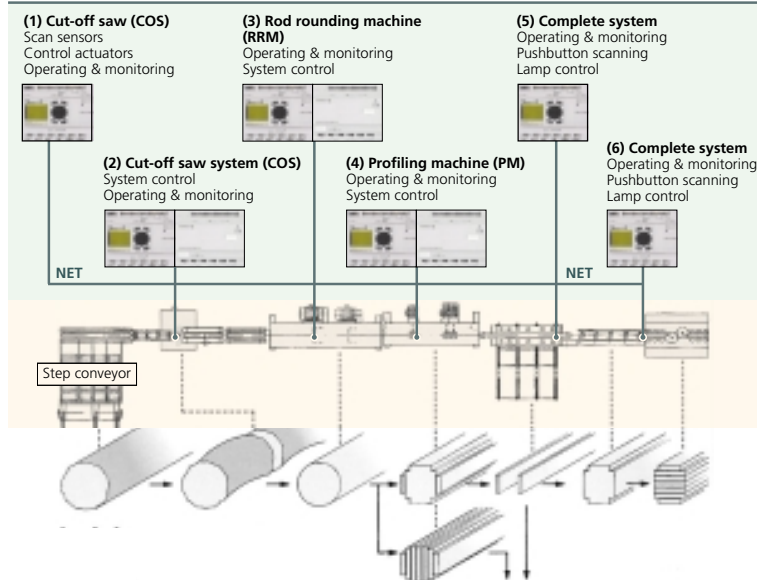

Modular control concept for woodworking systems

State-of-the-art machine concepts call for flexible and economic HMI and control solutions. A device concept consisting of a multi-function display and flexible control device allows a broad range of requirements to be fulfilled.

Inexpensive decentralised networking and expandability also make other additional applications possible, clearly demonstrated by this application for woodworking machines.

Wema Probst, based in Freigericht, Germany, uses the power of MFD-Titan and easy800 for the control of its new profiling system. Moeller's multi-function display provides networking already on board, from which not only the machine builders but also their end customers can benefit. The machines and systems from Wema Probst are designed for the field of small timber processing.

For example, the profiling system is used for the production of boards for making pallets, the production of wood for fences or also in the field of timber construction or laminated wood. In other words, these complete systems for processing small timber must also be adaptable. The profiling system itself consists of three system sections: firstly the wood feed and cut-off saw system (KSA), secondly the rod rounding machine (RHM), and thirdly the profiling machine (PSM).

A key function in the system concept

The Wema Probst automation concept requires that every system section is equipped with its own stand-alone control system. When supplying a complete system, the individual control systems should then be networked to control the entire system. The system should then be operated and monitored from a central control panel. "We can't and must not develop new system controls for each customer.

We want to be able to continually create new complete systems from existing elements," explained Peter Huber, who is responsible for purchasing and electrical engineering. Moeller's MFD-Titan multi-function display and the easy800 control relay are ideal for implementing this demanding control concept. The automation concept of the entire profiling system was developed as a modular structure.

The NET network is the basic foundation of the decentralised structure. It is a CAN-based network and is optimised for the data exchange of up to eight networked easy800 or MFD-Titan devices. Baud rates of up to 1 Mbit/sec can be run on the network, depending on the length of the cables installed. Each station can read the inputs and outputs of another station, without having to send complicated declarations beforehand. The control



relay passes on status changes automatically to the network. For example, in order to process input 1 of station 5 in the program of station 3, you just have to place the station address in front of the operand designation (I for input), i.e. 5 I1. Even user-friendly function blocks are also available for sending and receiving entire data areas.

Programming Example for a Sales Room and Shop Window Lighting

The control program is available
for downloading from:

<http://easy.moeller.net>

in the Download area

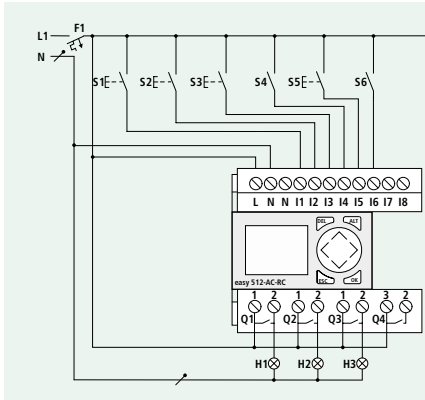

- S1-S3 Light switches for sales room lighting
- S4 Switch contact for twilight switch
- S5 Light switch for shop window lighting
- S6 Switch contact for alarm system
- H1 Outdoor neon sign
- H2 Shop window lighting
- H3 Sales room lighting
- F1 Miniature circuit-breaker, 16 A, Char. B

Task definition

The sales room lighting, shop window lighting and the outdoor neon sign of a shop have to be switched automatically. This control should process the day of the week, the time and the signals from a twilight switch. The switching times for the shop window lighting should be adjustable. It must be possible to switch all lights on and off manually. In the event of an alarm the sales room and shop window lighting should switch on.

Function description

→ Outdoor neon sign:
(time switch 1)
MO-SU 06:00 - 23:00

The outdoor neon sign is affected by the twilight switch and is switched off at dawn and switched on at dusk. It must be possible to switch the neon sign on and off manually at any time. The P2 (Up arrow) and P4 (Down arrow) function buttons on the "easy" are used for this purpose.

Note:

Use of the P buttons is enabled in the System menu. This menu is reached by pressing ALT and DEL simultaneously. Refer to the User Guide AWB 2528-1508.

→ Shop window lighting:
(time switch 2)
MO-FR 08:00 - 22:00
SA 08:00 - 23:00
SU 10:00 - 22:00

The shop window lighting is also controlled by the twilight switch: at dawn it is switched off; at dusk it is switched on. Pushbutton S5 is to be used to manually switch the shop window lighting on and off outside of the times set in the program. In the event of an alarm, the isolated contact S6 of the alarm system should switch on the shop window lighting. Even if a password was activated in the System menu, the switching times can be modified using the enabled time switch 2. The time switch is enabled by means of the "+" symbol in programming.

→ Sales room lighting:
(time switch 3)
MO-FR 08:55 - 13:05
13:55 - 18:35
SA 08:55 - 14:05

The flush-mounted pushbuttons S1, S2, S3 are used to activate the sales room lighting outside of the times set in the program. In the event of an alarm, the isolated contact S6 of the alarm system should switch on the sales room lighting.

Benefits

- Implemented functions:
3 x time switches, single-channel with week and day program
List price approx. 150 €
3 x impulse relays
List price approx. 30 €
- Less wiring required
- Less space required compared to conventional solution
- Password function for protection against unauthorised access

Programming Example for a Belt Sequence Control for 3 Conveyor Belts

The control program is available for downloading from:

<http://easy.moeller.net>

in the Download area

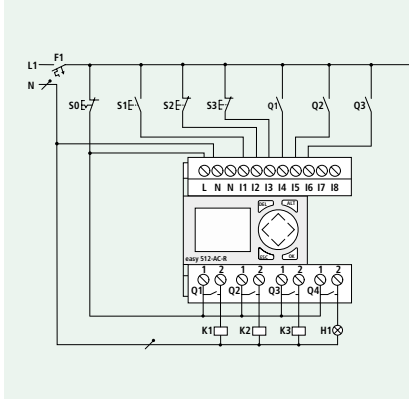
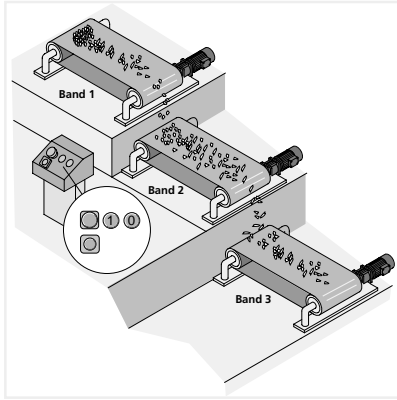

- S0** Emergency-stop
- S1** START pushbutton actuator
- S2** STOP pushbutton actuator
- S3** Quick STOP pushbutton actuator
- Q1 - Q3** Trip-indicating auxiliary contacts for motor 1 – 3
- K1 - K3** Motor for belt 1 – 3
- H1** Indicator light
- F1** miniature circuit-breaker, 16 A, Char. B

Task definition

Three conveyor belts are to start up and run down at staggered intervals. There are three operating modes: "Staggered Startup", "Staggered Run Down", and "Quick Stop". The motor-protective circuit-breakers of the belt drives are monitored; in the event of tripping, a controlled stop is initiated on the conveyor system. The cause of the fault should also be reported by means of a flashing light.

Function description

The three conveyor belts for a bulk material conveyor system are to start up and run down with staggered times in order to ensure safe and trouble-free material transport.

→ Startup:

This is initiated by the S1 START pushbutton actuator. The belts start up at fixed time intervals of five seconds each. Belt 3 starts up first.

→ Switch off:

After pushbutton actuator S2 STOP is pressed, the belts are to run down in reverse order starting with belt 1. This ensures that the belts are run empty and that a belt is not started up when it is under load. There should be a delay of

5 seconds between the pressing of the pushbutton actuator and the switching off of belt 1. The subsequent belts should then likewise switch off after 5 seconds. It should be possible to modify the time via the "easy" control relay; for this purpose, the "+" must be set in the function block programming. The "Quick Stop" pushbutton actuator S3 should switch off all three belts without a time delay.

→ Motor failure:

The trip-indicating auxiliary contact (PKZ) should open in the event of a motor failure. The fault is indicated with a flashing light and should cause the automatic initiation of the STOP procedure. This means that in the event of a fault, the belts downstream of the failed drive should be run empty for 5 seconds and then switched off.

The belts upstream of the failed drive should be switched off immediately.

Benefits

- Implemented functions:
 - 2 x timing relays, on-delayed
List price approx. 70 €
 - 2 x timing relays, off-delayed
List price approx. 120 €
 - 1 x flash relay
List price approx. 60 €
 - 2 x contactor relays
List price approx. 40 €
- Less wiring required
- Less space required compared to conventional solution
- Password function for protection against unauthorised access

Load current circuit

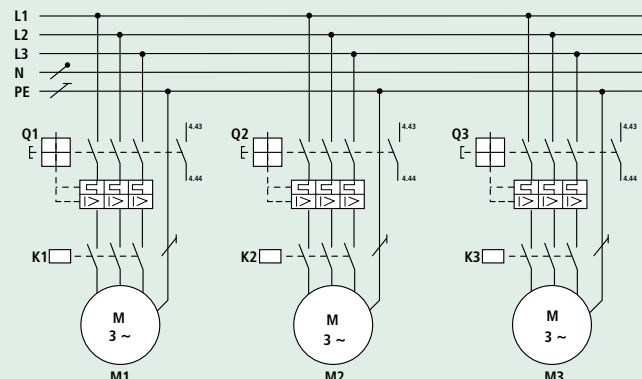

Programming Example

Booster Pumps

The control program is available for downloading from:

<http://easy.moeller.net>

in the Download area

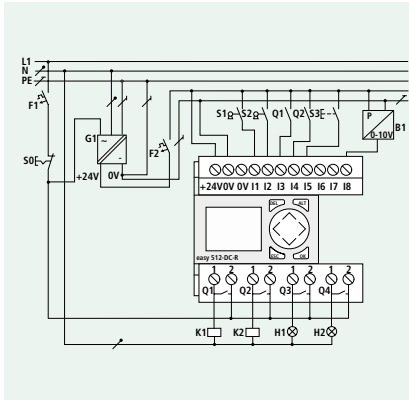
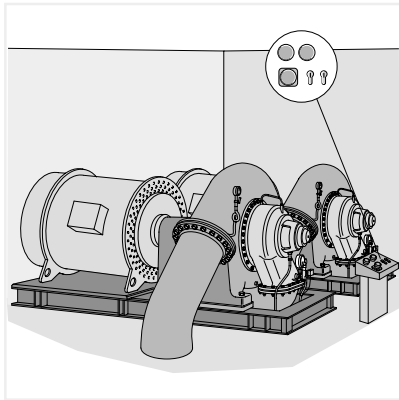

- B1 Pressure sensor
- F1 Miniature circuit-breaker, 16 A, Char. B
- F2 Miniature circuit-breaker (optional)
- G1 Power supply unit 230 V AC/24 V DC
- H1 Indicator light for pump 1
- H2 Indicator light for pump 2
- K1 Contactor for pump P1
- K2 Contactor for pump P2
- Q1 Trip-indicating auxiliary contact for pump 1
- Q2 Trip-indicating auxiliary contact for pump 2
- S0 Emergency-stop
- S1 Keyswitch for pump 1
- S2 Keyswitch for pump 2
- S3 Acknowledge button

Task definition

Two pumps provide the water supply to a system. Their function is to be monitored. The two pumps are to operate alternately in order to save wear. System operating states and faults are to be signalled by means of two indicator lights. It must be possible to set the pressure-dependent switching points as required for activating the pumps.

Function description

→ Pump operation:

The pump station provides the water supply to a system. In this process, the pressure should not go below a specified minimum pressure. The two booster pumps P1 and P2 are provided and, in the event of low pressure, one of them is activated by means of pressure sensor B1. In order to maintain an even utilisation and wearing of the pumps, they are run alternately every forty-eight hours. The two indicator lights H1 and H2 are used to indicate which of the two pumps is currently in operation. If "easy" is disconnected from the power supply, the counting of operating hours is restarted, and pump 1 is activated first of all. If the pumps are to be switched over before or after the set time, the counters C1 and C2 are to

switch to new comparison values according to the following equation:

Required changeover time in hours
 $\times 60 = \text{Comparison value}$

Preset:

48 hours $\times 60 = 2880$

→ Faults:

The failure of a pump motor is detected by means of the trip-indicating auxiliary contact of motor-protective circuit-breaker Q1 and Q2. The pump that is still functional is activated. If a pump is faulty, the resulting low pressure should be detected. The other pump should be activated after time T4 has elapsed. Both types of faults are indicated by means of the corresponding H1 and H2 indicator lights.

→ Low pressure:

The system is monitored for low pressure. Low pressure is indicated after

time T5 has elapsed by the alternate flashing of H1 and H2. It must be possible to enter the limit value for low pressure on the "easy".

→ Acknowledgement:

All fault messages shall be indicated until they are acknowledged via pushbutton actuator S3.

→ Maintenance:

It must be possible to switch pump P1 directly using keyswitch S1 and pump P2 using keyswitch S2.

Benefits

- Implemented functions:
 - 1 x flash relay
 - List price approx. 60 €
 - 2 x timing relays, on-delayed
 - List price approx. 70 €
 - 1 x operating hours counter
- Pressure value processing (analog value)
- Variable switching points and operating hours changeover
- Less wiring required
- Less space required compared to conventional solution

Load current circuit

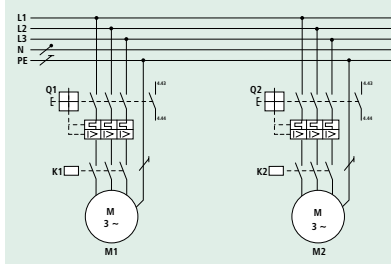

Moeller addresses worldwide:
www.moeller.net/address
E-Mail: info@moeller.net

© 2004 by Moeller GmbH
Subject to alterations
W2528-7557GB MDS/DM 04/04
Printed in the Federal Republic of Germany (06/04)
Article No.: 284718



Xtra Combinations

Xtra Combinations from Moeller offers a range of products and services, enabling the best possible combination options for switching, protection and control in power distribution and automation.

Using Xtra Combinations enables you to find more efficient solutions for your tasks while optimising the economic viability of your machines and systems.

It provides:

- flexibility and simplicity
- great system availability
- the highest level of safety

All the products can be easily combined with one another mechanically, electrically and digitally, enabling you to arrive at flexible and stylish solutions tailored to your application – quickly, efficiently and cost-effectively. The products are proven and of such excellent quality that they ensure a high level of operational continuity, allowing you to achieve optimum safety for your personnel, machinery, installations and buildings.

Thanks to our state-of-the-art logistics operation, our comprehensive dealer network and our highly motivated service personnel in 80 countries around the world, you can count on Moeller and our products every time. Challenge us! We are looking forward to it!

MOELLER 

Think future. Switch to green.