

RKT

Aktor-/Sensor-Anschlussleitung, M12-Kupplung mit selbstsicherndem Schraubverschluss und angespritztem Kabel
 8-6-polig: zum Anschluss an steckbaren Miniatur-Sensor-Verteiler Typ SBS
 12-polig: zum Anschluss an steckbaren Aktor-Sensor-Verteiler Typ ASBSM

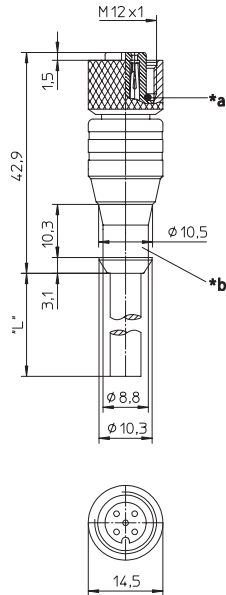

Actuator/sensor cordset, single-ended, M12 female connector with self-locking threaded joint and molded cable
 8-6-poles: to connect at plug-gable miniature sensor distribution box type SBS
 12 poles: to connect at plug-gable miniature actuator/sensor distribution box type ASBSM



*a O-Ring
 O-ring
 *b Schutzschlauchmontage
 hose mounting

RKWT

Aktor-/Sensor-Anschlussleitung, M12-Winkelkupplung mit selbstsicherndem Schraubverschluss und angespritztem Kabel
 8-6-polig: zum Anschluss an steckbaren Miniatur-Sensor-Verteiler Typ SBS

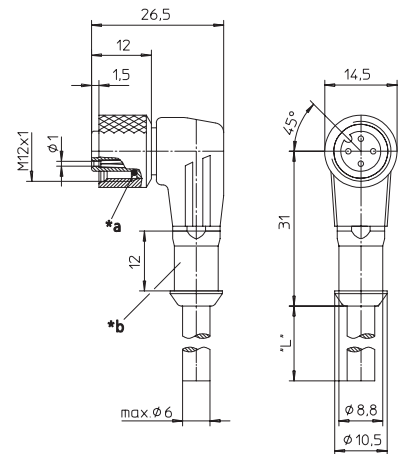

*a O-Ring
 O-ring
 *b Schutzschlauchmontage
 hose mounting

Pinbelegung Pin assignment

3-polig 3 poles



1 = braun / brown
 2 = n.c.
 3 = blau / blue
 4 = schwarz / black

4-polig 4 poles



1 = braun / brown
 2 = weiß / white
 3 = blau / blue
 4 = schwarz / black

5-polig 5 poles



1 = braun / brown
 2 = weiß / white
 3 = blau / blue
 4 = schwarz / black
 5 = grün/gelb / green/yellow
 (RK(W)T 5-56/...M = grau/grey)

6-polig 6 poles



1 = weiß / white
 2 = grün / green
 3 = gelb / yellow
 4 = grau / grey
 5 = braun / brown
 6 = n.c.
 7 = blau / blue
 8 = n.c.

8-polig 8 poles



1 = weiß / white
 2 = braun / brown
 3 = grün / green
 4 = gelb / yellow
 5 = grau / grey
 6 = rosa / pink
 7 = blau / blue
 8 = Schirm / shield





















































12-polig 12 poles



1 = braun / brown
 2 = blau / blue
 3 = weiß / white
 4 = grün / green
 5 = rosa / pink
 6 = gelb / yellow
 7 = schwarz / black
 8 = grau / grey
 9 = rot / red
 10 = violett / violet
 11 = grau/rosa / grey/pink
 12 = rot/blau / red/blue

Anschlussleitungen für Aktoren, Sensoren und Verteiler Cordsets, single-ended, for actuators, sensors and distribution boxes

Technische Daten		Technical data	
Umgebungstemperatur	-25°C / +80°C	Operating temperature range	-25°C / +80°C
Werkstoffe		Materials	
Gehäuse / Griffkörper	TPU	Housing / Molded body	TPU
Kontaktträger	TPU	Insert	TPU
Kontakt	CuSn (12-polig: CuZn), unternickelt und 0,3 µm vergoldet	Contact	CuSn (12 poles: CuZn), pre-nickelated and 0.3 microns gold-plated
Gewindebuchse / Rändelschraube/-mutter / Sechskantschraube/-mutter / Hülse	CuZn, vernickelt	Receptacle shell / knurled screw/nut / hexagon screw/nut / sleeve	CuZn, nickel-plated
O-Ring	FKM	O-ring	FKM
Mechanische Daten		Mechanical data	
Schutzart	IP 67 Nur im verschraubten Zustand mit den dazugehörigen Gegenständen.	Degree of protection	IP 67 Only in locked position with its proper counterparts.
Elektrische Daten		Electrical data	
Durchgangswiderstand	≤ 5 mΩ	Contact resistance	≤ 5 mΩ
Nennstrom bei 40°C	3- bis 5-polig 4 A, 6- bis 12-polig 2 A	Nominal current at 40°C	3-5 poles 4 A, 6-12 poles 2 A
Nennspannung	3- bis 4-polig 240 V, 5-polig 60 V, 6- bis 12-polig 30 V	Nominal voltage	3-4 poles 240 V, 5 poles 60 V, 6-12 poles 30 V
Bemessungsspannung	3- bis 4-polig 250 V, 5-polig 63 V, 6- bis 12-polig 36 V	Rated voltage	3-4 poles 250 V, 5 poles 63 V, 6-12 poles 36 V
Prüfspannung	3- bis 4-polig 2,0 kV eff. / 60 s 5- bis 8-polig 1,5 kV eff. / 60 s 12-polig 0,5 kV eff. / 60 s	Test voltage	3-4 poles 2.0 kV eff. / 60 s 5-8 poles 1.5 kV eff. / 60 s 12 poles 0.5 kV eff. / 60 s
Isolationswiderstand	> 10 ⁹ Ω	Insulation resistance	> 10 ⁹ Ω
Verschmutzungsgrad	3	Pollution degree	3

Bestellbezeichnung Designation		Polzahl Poles	Mantel Outer jacket	
RKT 4-3-06/... M	RKWT 4-3-06/... M		PVC	 
RKT 4-3-224/... M	RKWT 4-3-224/... M	3	PUR halogenfrei / halogen free	   
RKT 4-3-260/... M	RKWT 4-3-260/... M		PUR halogenfrei / halogen free schweißfunkenfest / welding spark proof	   
RKT 4-07/... M	RKWT 4-07/... M		PVC	 
RKT 4-225/... M	RKWT 4-225/... M	4	PUR halogenfrei / halogen free	   
RKT 4-251/... M	RKWT 4-251/... M		PUR halogenfrei / halogen free schweißfunkenfest / welding spark proof	   
			PUR halogenfrei / halogen free schweißfunkenfest / welding spark proof	   
RKT 5-56/... M	RKWT 5-56/... M		PVC	 
RKT 5-226/... P89 <small>(Pin 2 und 4 nicht belegt / Pin 2 and 4 not connected)</small>		5	PUR halogenfrei / halogen free	   
RKT 5-228/... M	RKWT 5-228/... M		PUR halogenfrei / halogen free	   
RKT 5-259/... M			PUR halogenfrei / halogen free schweißfunkenfest / welding spark proof	   
RKT 8-6-268/... M	RKWT 8-6-268/... M	6	PUR halogenfrei / halogen free schweißfunkenfest / welding spark proof	   
RKT 8-6-337/... M	RKWT 8-6-337/... M		PUR halogenfrei / halogen free	   
RKT 8-282/... M	RKWT 8-282/... M	8	PUR	   
RKT 12-348/... M	RKWT 12-348/... M	12	PUR halogenfrei / halogen free	  
Standardlängen: 2 M / 5 M / 10 M Andere Kabellängen oder Leitungsaufbauten auf Anfrage.			Standard lengths: 2 M / 5 M / 10 M Other cable lengths or cable specifications on request.	

RKT / RST 3-, 4-, 5- 6- and 12-Pole

Micro (M12), Single Ended Cordset, Female and Male Straight, 3-, 4-, 5-, 6-, 8-, and 12-pole, 24, 22 and 20 AWG, Halogen Free Lumflex black PUR cable, EURO DC Color Code, IP 67 and NEMA 6P rated.

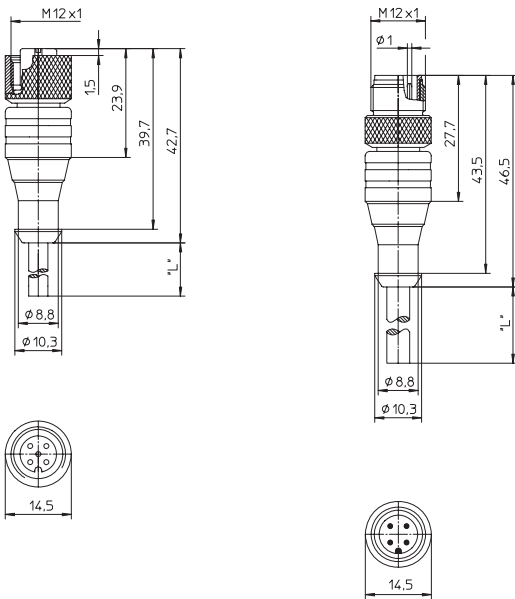

RKWT / RSWT 3-, 4-, 5- 6- and 12-Pole

Micro (M12), Single Ended Cordset, Right Angle Female and Male, 3-, 4-, 5-, 6-, 8-, and 12-pole, 24, 22 and 20 AWG, Halogen-Free Lumflex black PUR cable, EURO DC Color Code, IP 67 and NEMA 6P rated.

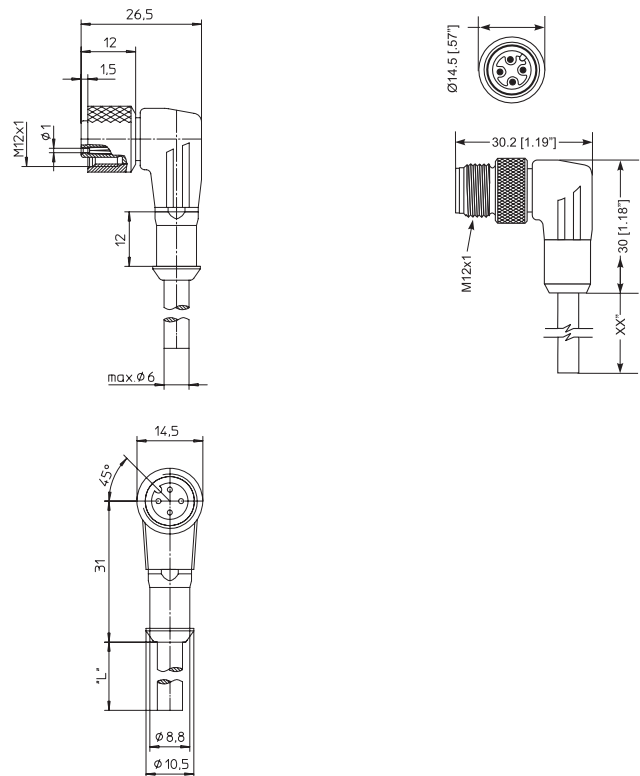

Pin Assignment

Micro (M12) Female / Male

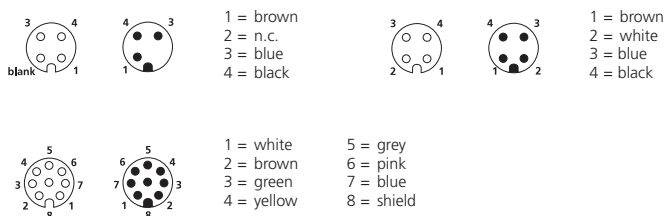

Micro (M12) Female

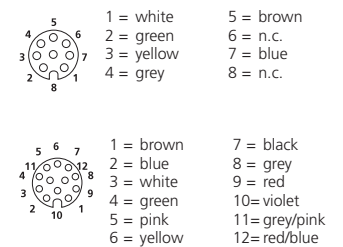

PUR

halogen-free

Euro DC Color Code

UL Type: AWM style 21198 or 20549

Gauge: 26 / 24 / 22 / 20

Cable Specifications				
Cable Number	Outer Jacket	Conductor Size	Color	Outside Diameter
224	PUR, halogen-free	22 AWG	Black	.169" (4.3 mm)
225	PUR, halogen-free	22 AWG	Black	.185" (4.7 mm)
228	PUR, halogen-free	20 AWG	Black	.213" (5.4 mm)
282	PUR, halogen-free	24 AWG	Black	.236" (6.0 mm)
337	PUR, halogen-free	22 AWG	Black	.236" (6.0 mm)
348	PUR, halogen-free	10 x 26 AWG 2 x 24 AWG	Black	.236" (6.0 mm)

Mating Receptacles			
Part Number	Male Receptacle	Part Number	Female Receptacle
RKT 4-3-224/...M RKWT 4-3-224/...M	RSF 3/0.5 M	RST 3-224/...M RSWT 3-224/...M	RKF 4-3/0.5 M
RKT 4-225/...M RKWT 4-225/...M	RSF 4/0.5 M	RST 4-225/...M RSWT 4-225/...M	RKF 4/0.5 M
RKT 5-228/...M RKWT 5-228/...M	RSF 5/0.5 M	RST 5-228/...M	RKF 5/0.5 M
RKT 8-282/...M RKWT 8-282/...M	RSF 8/0.5M	RST 8-282/...M	RKF 8/0.5 M

Part Number	Female Straight	Male Straight	Female Right Angle	Male Right Angle	Poles	
RKT 4-3-224/...M	RST 3-224/...M	RKWT 4-3-224/...M	RSWT 3-224/...M	3		
RKT 4-225/...M	RST 4-225/...M	RKWT 4-225/...M	RSWT 4-225/...M	4		
RKT 5-228/...M	RST 5-228/...M	RKWT 5-228/...M		5		
RKT 8-6-337/...M		RKWT 8-6-337/...M		6		
RKT 8-282/...M	RST 8-282/...M	RKWT 8-282/...M		8		
RKT 12-348/...M		RKWT 12-348/...M		12		

Standard cable lengths: 2 M / 5 M / 10 M
Other cable lengths or cable specifications on request.

Technical Data

Degree of protection IP 67 / NEMA 6P
Operating temperature range -25°C (-13°F) / +80°C (+176°F)

Mechanical

Insert TPU, self-extinguishing
Molded body TPU, self-extinguishing
Contact Brass, pre-nickel and 0.3 microns gold-plated

Coupling nut Brass, nickel-plated
O-ring FKM

Electrical

Contact resistance ≤5mΩ
Voltage rating 3-4 poles: 240 V
5 poles: 60 V
6-12 poles: 30 V

Current rating 3-5 poles: 4 A
6-8 poles: 2 A
12 poles: 1.5A

Mini

Micro (M12)

Micro (1/2"-20)

Pico (M8)

Din Valve Connectors

References