

BJ Series

Compact and Long sensing distance/Micro spot type

■ Features

■ Long distance sensing type

- Long sensing distance with high quality lens
- Detects up to 15m (Transmitted beam type)
- Long sensing distance : Diffuse reflective type 1m, Polarized reflective type 3m (MS-2A)
- M.S.R (Mirror Surface Rejection) function (Polarized retroreflective type)

■ Transparent glass sensing type / Micro spot type

- Stable detection for transparent object (LCD, PDP, glass etc) by BJJ30-DDT.
- Easy to check sensing location with Red LED
- Suitable for sensing small objects (Min. sensing object: $\varnothing 0.2\text{mm}$ pure copper wire)

⚠ Please read "Caution for your safety" in operation manual before using.

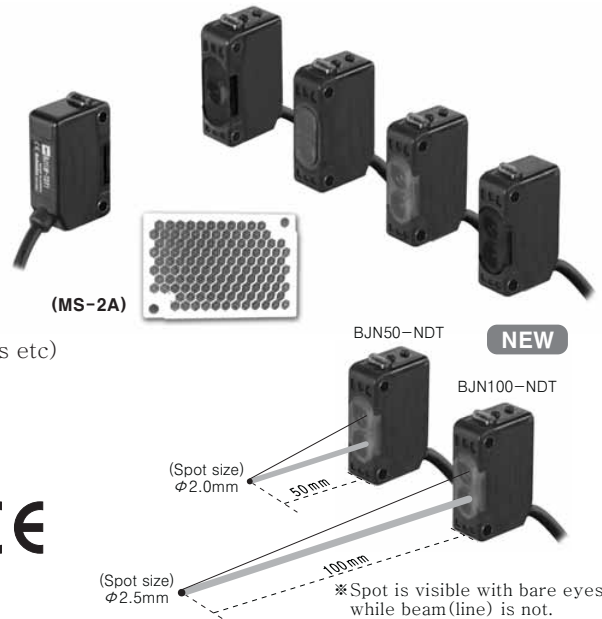

■ Specifications

Model	NPN Open collector output	BJ15M-TDT	BJ10M-TDT	BJ7M-TDT	BJ3M-PDT	BJ1M-DDT	BJ300-DDT	BJ100-DDT	
	PNP Open collector output	BJ15M-TDT-P	BJ10M-TDT-P	BJ7M-TDT-P	BJ3M-PDT-P	BJ1M-DDT-P	BJ300-DDT-P	BJ100-DDT-P	
Sensing type	Through-beam				Polarized retroreflective	Diffuse reflective			
Sensing distance	0~15m	0~10m	0~7m	(★)0.1~3m (MS-2A)	1m (Non-glossy white paper 300×300mm)	300mm (Non-glossy white paper 100×100mm)	100mm (Non-glossy white paper 100×100mm)		
Sensing target	Opaque material over $\varnothing 12\text{mm}$		Opaque material over $\varnothing 8\text{mm}$	Opaque material over $\varnothing 75\text{mm}$	Translucent, Opaque materials				
Hysteresis	—				Max. 20% at rated setting distance				
Response time	Max. 1ms								
Power supply	12~24VDC $\pm 10\%$ (Ripple P-P: Max.10%)								
Current consumption	Emitter/Receiver : Max. 20mA				Max. 30mA				
Light source	Infrared LED (850nm)	Red LED (660nm)	Red LED (Point light source 650nm)	Red LED (660nm)	Infrared LED (850nm)	Red LED (660nm)	Infrared LED (850nm)		
Sensitivity adjustment	Built-in VR								
Operation mode	Light ON/Dark ON mode selectable								
Control output	NPN open collector output								
	• Load voltage : Max. 26.4VDC • Load current : Max. 100mA • Residual voltage : Max. 1V PNP open collector output • Load voltage : Max. 26.4VDC • Load current : Max. 100mA • Residual voltage : Min. (Power supply-2.5V)								
Protection circuit	Reverse polarity protection, Output short-circuit protection			Reverse polarity protection, Interference prevention function, Output short-circuit protection					
Indicator	Operation : Red, Stable : Green (Emitter's power indicator : Green)								
Connection	Outgoing cable type								
Insulation resistance	Max. 20M Ω (at 500VDC megger)								
Dielectric strength	1000VAC 50/60Hz for 1minute								
Vibration	1.5mm or 300mm amplitude at frequency of 10 ~ 55Hz in each of X, Y, Z directions for 2 hours								
Shock	500m/s ² X, Y, Z directions for 3 times								
Ambient illumination	Sunlight : Max. 11,000lx, Incandescent lamp : Max. 3,000lx (Receiver illumination)								
Ambient temperature	Operation : -25 ~ 55°C, Storage : -40 ~ 70°C (at non-freezing, at non-dew status)								
Ambient humidity	(at non-freezing, at non-dew status)								
Protection	IP65 (IEC standard)								
Material	Case : PC+ABS, Lens : PMMA, LED Cap : PC								
Cable	$\varnothing 3.5\text{mm}$, 3P, Length : 2m (Emitter of transmitted beam type : $\varnothing 3.5\text{mm}$, 2P, Length : 2m) 22AWG, Core wire diameter: 0.08mm, No. of core wire: 60								
Accessory	Common	Mounting bracket, Bolt, Nut, VR adjustment driver							
	Individual	—			Reflector (MS-2A)	—			
Approval	CE								
Unit weight	Approx. 90g			Approx. 60g		Approx. 45g			

*(★) The sensing distance is extended to 0.1~4m or 0.1~5m when using optional reflector MS-2S or MS-3S.

Long sensing distance/Micro spot type

Specifications

Model	NPN open collector output	BJG30-DDT		BJN50-NDT	BJN100-NDT
	PNP open collector output	—		BJN50-NDT-P	BJN100-NDT-P
Sensing type	Diffuse reflective		Diffuse reflective(Narrow beam)		
Power supply	12-24VDC ±10% (Ripple P-P : Max.10%)				
Current consumption	Max. 30mA				
Min.diameter of transmitting SPOT	—		Approx. φ 2.0mm	Approx. φ 2.5mm	
Min.sensing target	—		Approx. min. φ 0.2mm(Copper wire)		
Sensing distance	0~30mm	0~15mm	30~70mm	70~130mm	
Sensing target	100×100mm Non-glossy white paper	Transparent glass 50×50mm (t=3.0mm)	Transparent, Translucent, Opaque materials (100×100mm Non-glossy white paper)		
Hysteresis	Max. 20% at sensing distance		Max. 25% at sensing distance	Max. 20% at sensing distance	
Light source / Wavelength	Infrared LED(850nm)		Pin Point LED(Point source) / 650nm		
Control output	NPN Open collector type • Load voltage : Max. 26.4VDC • Load current : Max. 100mA • Residual voltage		NPN or PNP Open collector type • Load voltage : Max. 26.4VDC • Load current : Max. 100mA • Residual voltage ⇒ NPN : Max. 1V, PNP : Min. (Power voltage -2.5V)		
Operation mode	Light ON mode fixed		Light ON / Dark ON mode selectable(Short rotator adjuster)		
Protection circuit	Reverse polarity protection, Output short-circuit protection, Interference prevention function				
Response time	Max. 1ms				
Sensitivity adjustment	Short rotation VR(210°)				
Ambient illumination	Sunlight : Max. 11,000lx, Incandescent lamp : Max. 3,000lx(Receiver illumination)				
Ambient temperature	Operation:-25~55°C, Storage:-40~70°C (at non-freezing, non-dew status)				
Ambient humidity	Operation & Storage : 35~85%RH(at non-dew status)				
Insulation resistance	Min. 20MΩ (at 500VDC megger)				
Dielectric strength	1,000VAC 50/60Hz for 1minute				
Vibration	1.5mm or 300m/s ² amplitude at frequency of 10~55Hz in each of X, Y, Z directions for 2 hours				
Shock	500m/s ² X, Y, Z directions for 3 times				
Protection	IP65 (IEC standard)				
Connection	Outgoing cable type				
Indicator	Operation indicator : Red, Stability indicator : Green				
Material	Case : PC+ABS, Lens : PMMA, LED CAP : PC				
Cable	φ 3.5mm, 3P, Length : 2m				
Accessory	Mounting bracket, Bolt		Mounting bracket, Bolt, Adjustment driver		
Approval	CE				
Unit weight	Approx. 45g				

Feature data

Through-beam

●BJ15M-TDT / BJ15M-TDT-P / BJ10M-TDT / BJ10M-TDT-P / BJ7M-TDT / BJ7M-TDT-P

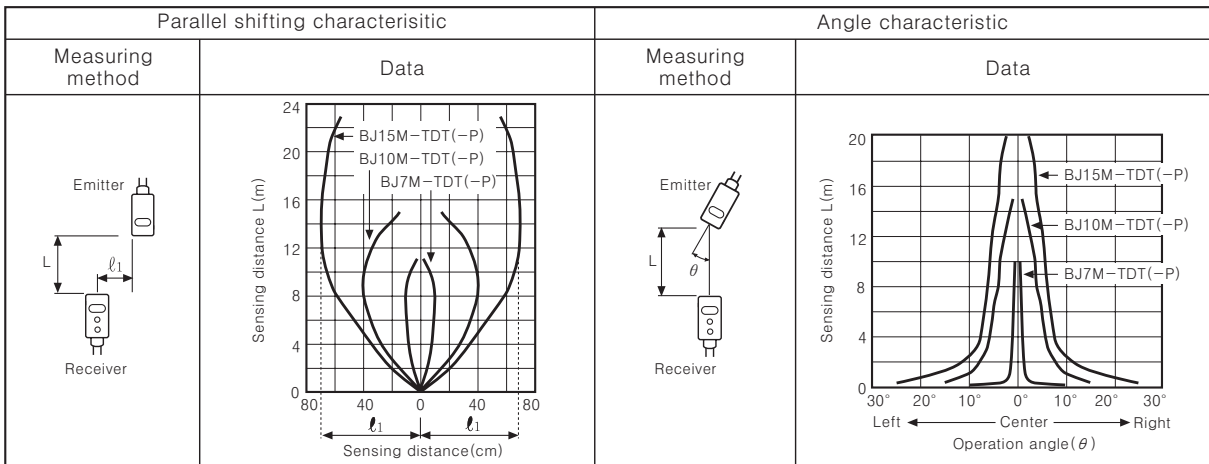

(A) Counter

(B) Timer

(C) Temp. controller

(D) Power controller

(E) Panel meter

(F) Tacho/ Speed/ Pulse meter

(G) Display unit

(H) Sensor controller

(I) Switching power supply

(J) Proximity sensor

(K) Photo electric sensor

(L) Pressure sensor

(M) Rotary encoder

(N) Stepping motor & Driver & Controller

(O) Graphic panel

(P) Field network device

(Q) Production stoppage models & replacement

BJ Series

Feature data

Polarized retroreflective

BJ3M-PDT / BJ3M-PDT-P

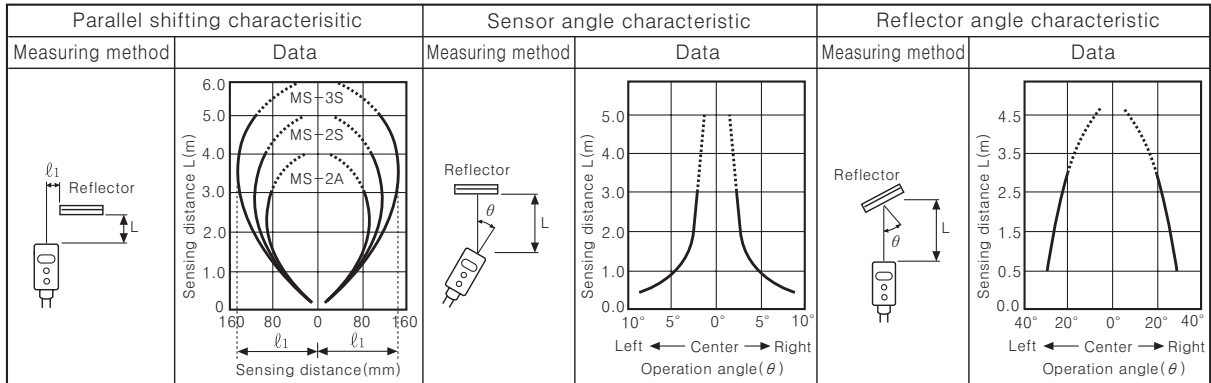

Diffuse reflective

BJ1M-DDT / BJ1M-DDT-P

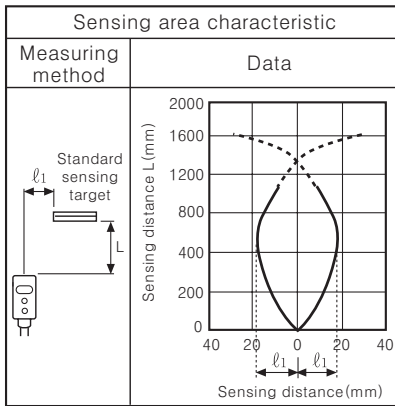

BJ300-DDT / BJ300-DDT-P

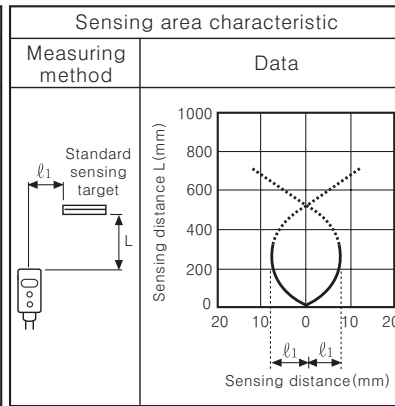

BJ100-DDT / BJ100-DDT-P

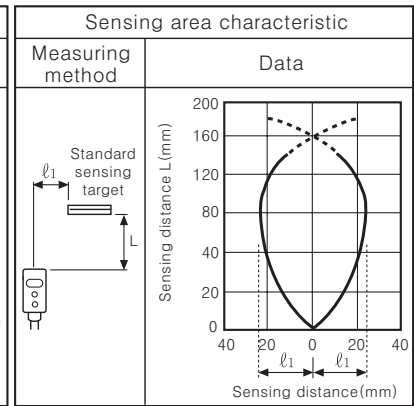

BJG30-DDT

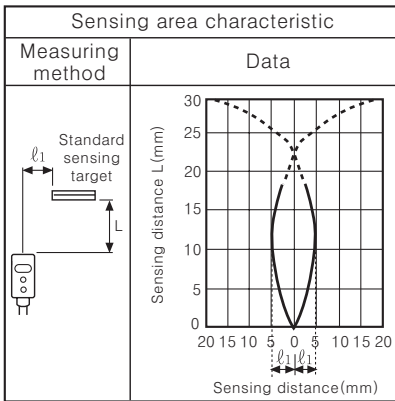

BJN50-NDT / BJN50-NDT-P

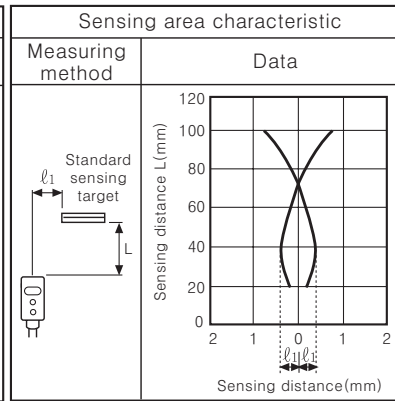

BJN100-NDT / BJN100-NDT-P

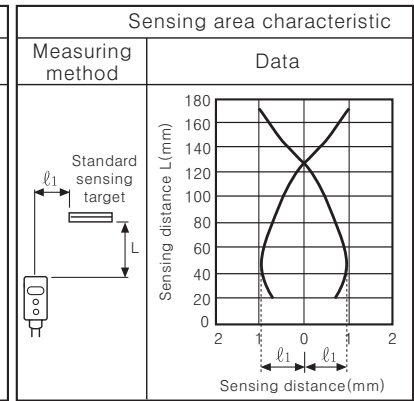

Connections

Through-beam

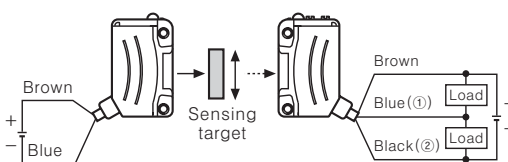

Polarized retroreflective type

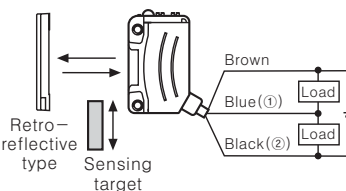

Diffuse reflective

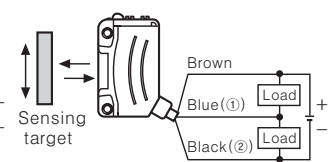

※① : The load connection of NPN open collector output, ② : The load connection of PNP open collector output

Long sensing distance/Micro spot type

Control output diagram

●NPN output

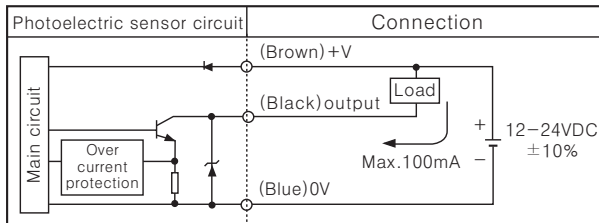

●PNP output

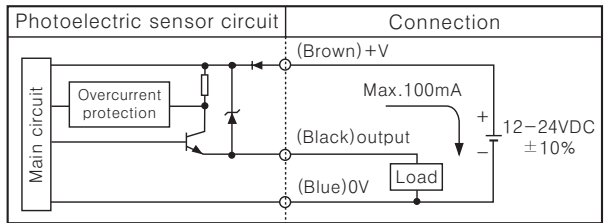

Operation mode

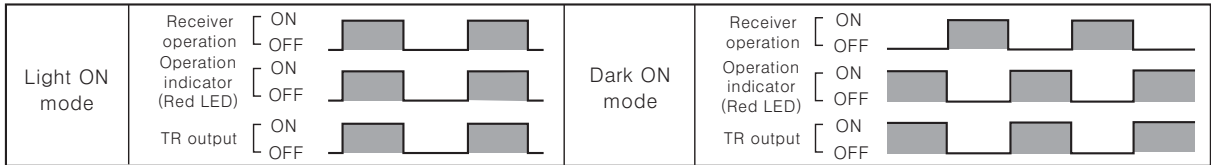

Dimensions

(Unit: mm)

●Through-beam type

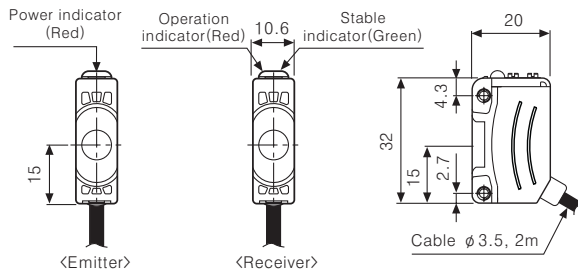

●Reflector (Include: MS-2A, Sold separately: MS-2S, MS-3S)

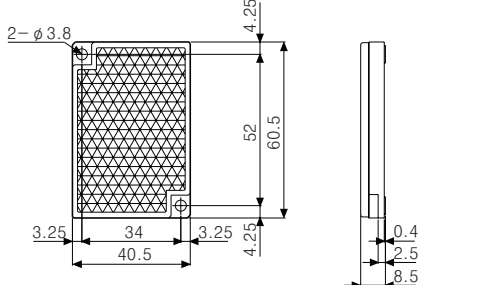

●Diffuse reflective type (Connect the bracket A)

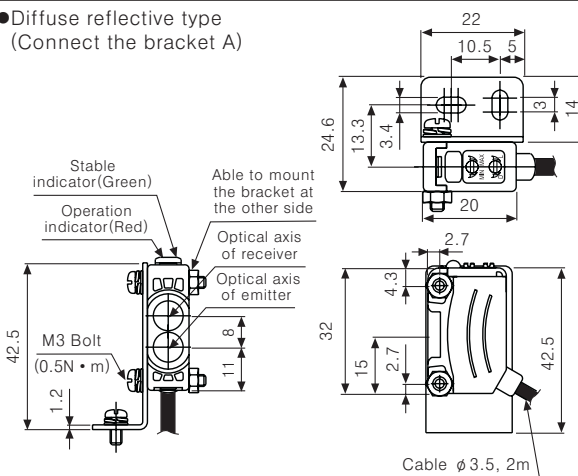

●Polarized retroreflective type (Connect the bracket B)

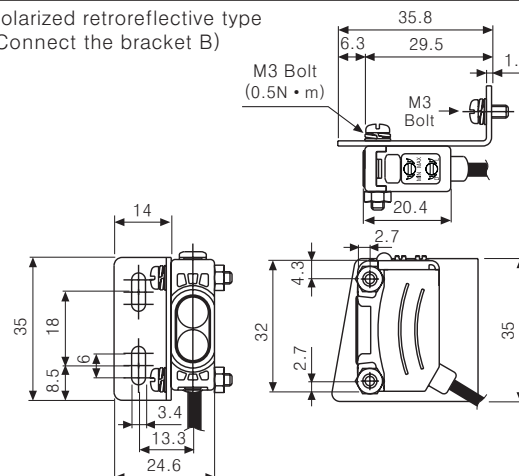

●Bracket A

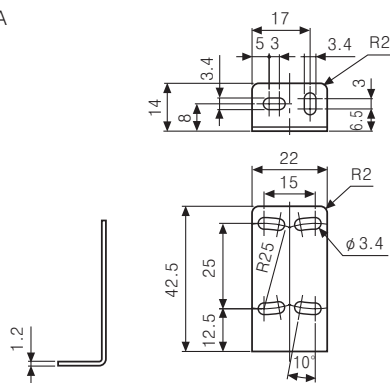

●Bracket B (Sold separately)

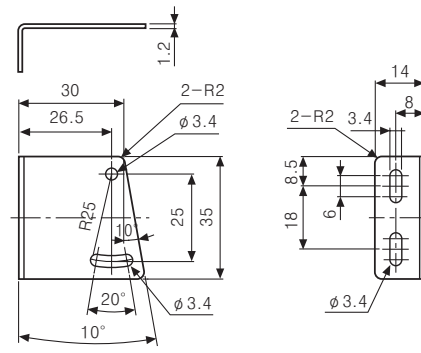

(A) Counter

(B) Timer

(C) Temp. controller

(D) Power controller

(E) Panel meter

(F) Tacho/Speed/Pulse meter

(G) Display unit

(H) Sensor controller

(I) Switching power supply

(J) Proximity sensor

(K) Photo electric sensor

(L) Pressure sensor

(M) Rotary encoder

(N) Stepping motor & Driver & Controller

(O) Graphic panel

(P) Field network device

(Q) Production stoppage models & replacement

BJ Series

Operation mode and Timing diagram

Emitter

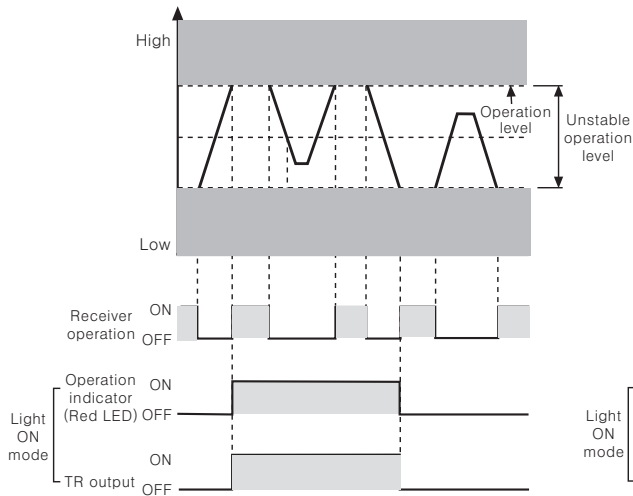

Diffuse reflective/Polarized retroreflective

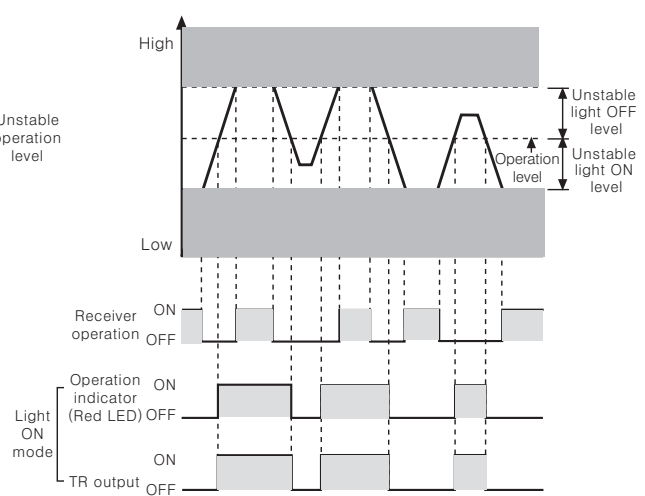

※The waveform of 'Operation mode indicator' and 'TR output' is for Light ON mode, it is operated as reverse in Dark ON mode.

Mounting and sensitivity adjustment

For mounting

Please use screw M3 for mounting of sensor, set the tightening torque under 0.5 N · m.

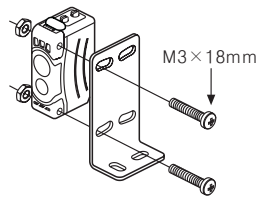

Switching of operation mode

Light ON mode (Light ON)		Turn the operation switching adjuster to right(L direction), it is set as Light ON mode.
Light OFF mode (Dark ON)		Turn the operation switching adjuster to left(D direction), it is set as Light OFF mode.

※The operation switching adjuster is installed in the receiver for transmitted beam type.

Mounting

Through-beam type

- Place the emitter and receiver facing each other and apply the power.
- After adjust the position of the emitter and receiver and check their stable indicating range, mount them in the middle of the range.
- After mounting, check the operation of sensor and lighting of stable indicator in both status. (None or sensing target status)

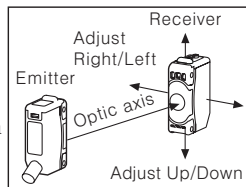

※When the sensing target is translucent or small (Under ϕ 16mm), it can be missed by the sensor because the light can penetrate it.

Polarized retroreflective type

- Place the Sensor and retroreflective facing each other and apply the power.
- After adjust the position of the Sensor and retro-reflective and check their stable indicating range, mount them in the middle of the range.
- After mounting, check the operation of sensor and lighting of stable indicating in both status. (None or sensing target status)

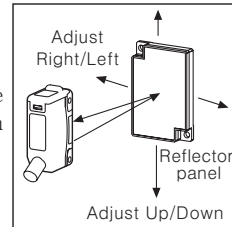

Diffuse reflective type

- After place a sensing target, adjust the sensor to up • down, left • right. Then, fix the sensor in center of position where the indicator is operating.

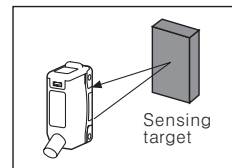

Object (Copper wire) detection <Micro spot type>

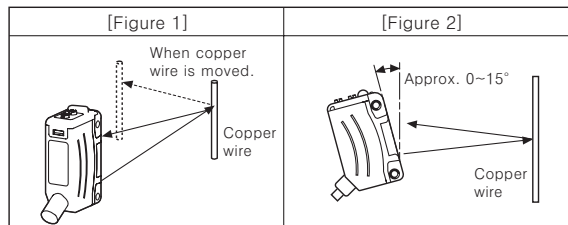

※Mount sensor slanted at an angle ranged 0~15° shown above as [Figure 2] for stable detection to detect as shown in [Figure 1].

Long sensing distance/Micro spot type

■ Sensitivity adjustment

◎ Sensitivity adjustment

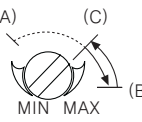
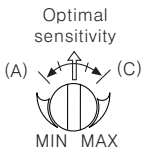
Order	Position	Description
1		Turn the sensitivity adjuster to the right of min. and check position(A) where the indicator is turned on in "Light ON status".
2		Turn the sensitivity adjuster more to the right of position(A), check position(B) where the indicator is turned on. And turn the adjuster to the left, check position(C) where the indicator is turned off in "Dark ON status". *If the indicator is not lighted although the adjuster is turned to the max. position, the max. position is(C).
3		Set the adjuster at the center of (A) and (C). To set the optimum sensitivity, check the operation and lighting of stable indicator with sensing target or without it. If the indicator is not lighted, please check the sensing method again because sensitivity is unstable.

*No sensitivity adjustment function available for BJJ30-DDT models

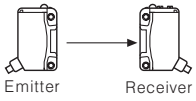
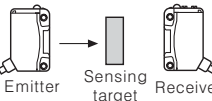
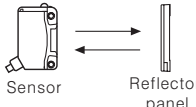
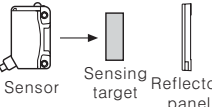
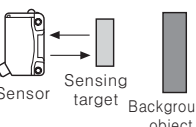
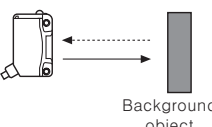
	"Light ON status"	"Light OFF status"
Through-beam type		
Polarized retro-reflective type		
Diffuse reflective		

*Set the sensitivity to operate in a stable light ON area, the reliability for the environment (Temperature, voltage, dust etc) will be increased.

*Do not apply an excessive force on adjuster, it can be broken.

(A) Counter

(B) Timer

(C) Temp. controller

(D) Power controller

(E) Panel meter

(F) Tacho/Speed/Pulse meter

(G) Display unit

(H) Sensor controller

(I) Switching power supply

(J) Proximity sensor

(K) Photo electric sensor

(L) Pressure sensor

(M) Rotary encoder

(N) Stepping motor & Driver & Controller

(O) Graphic panel

(P) Field network device

(Q) Production stoppage models & replacement