

LM4952 Boomer® Audio Power Amplifier Series

3.1W Stereo-SE Audio Power Amplifier with DC Volume Control

General Description

The LM4952 is a dual audio power amplifier primarily designed for demanding applications in flat panel monitors and TV's. It is capable of delivering 3.1 watts per channel to a 4Ω single-ended load with less than 1% THD+N when powered by a 12V_{DC} power supply.

Eliminating external feedback resistors, an internal, DC-controlled, volume control allows easy and variable gain adjustment.

Boomer audio power amplifiers were designed specifically to provide high quality output power with a minimal amount of external components. The LM4952 does not require bootstrap capacitors or snubber circuits. Therefore, it is ideally suited for display applications requiring high power and minimal size.

The LM4952 features a low-power consumption active-low shutdown mode. Additionally, the LM4952 features an internal thermal shutdown protection mechanism along with short circuit protection.

The LM4952 contains advanced pop & click circuitry that eliminates noises which would otherwise occur during turn-on and turn-off transitions.

Key Specifications

- Quiescent Power Supply Current 18mA (typ)
- P_{OUT}
V_{DD} = 12V, R_L = 4Ω, 10% THD+N 3.8W (typ)
- Shutdown current 55μA (typ)

Features

- Pop & click circuitry eliminates noise during turn-on and turn-off transitions
- Low current, active-low shutdown mode
- Low quiescent current
- Stereo 3.8W output, R_L = 4Ω
- DC-controlled volume control
- Short circuit protection

Applications

- Flat Panel Monitors
- Flat panel TV's
- Computer Sound Cards

Connection Diagram

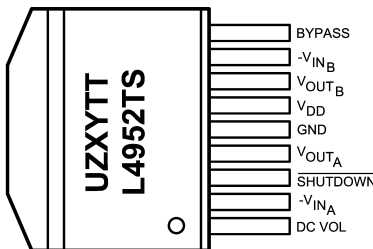

200809E9

Top View
Order Number LM4952TS
See NS Package Number TS9A
U = Wafer Fab Code
Z = Assembly Plant Code
XY = Date Code
TT = Die Traceability
L4952TS = LM4952TS

Boomer® is a registered trademark of National Semiconductor Corporation.

Typical Application

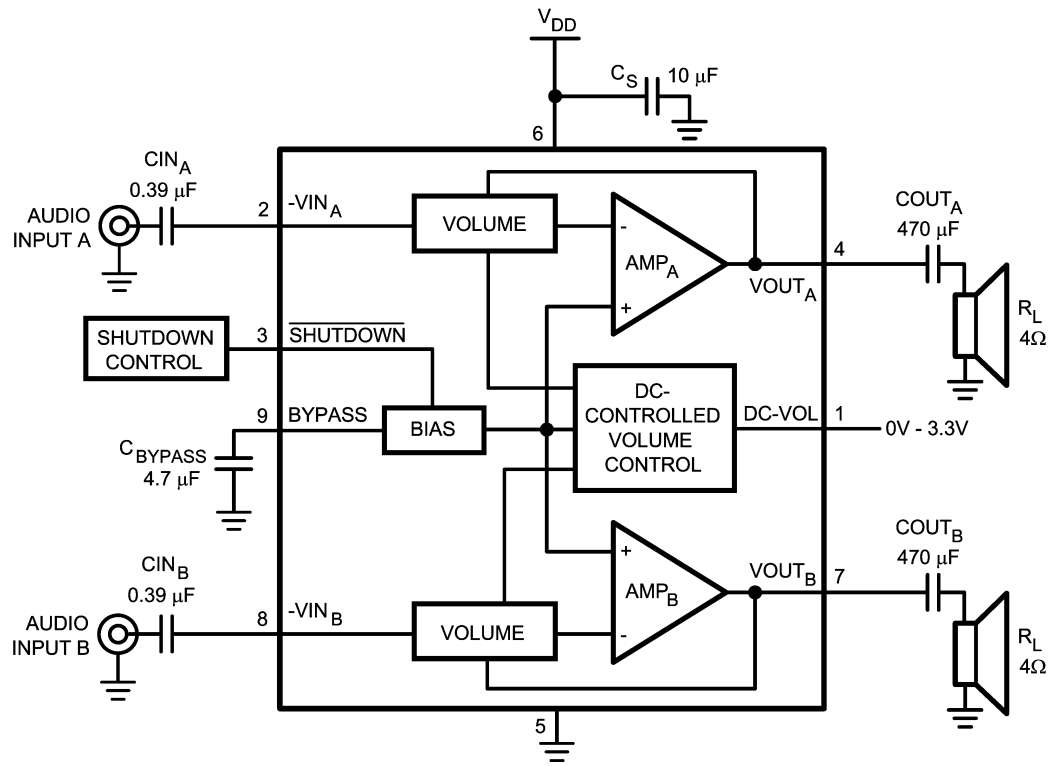

200809E8

FIGURE 1. Typical LM4952 SE Audio Amplifier Application Circuit

Absolute Maximum Ratings (Notes 1, 2)

If Military/Aerospace specified devices are required, please contact the National Semiconductor Sales Office/Distributors for availability and specifications.

Supply Voltage (pin 6, referenced to GND, pins 4 and 5)	18.0V
Storage Temperature	-65°C to +150°C
Input Voltage	
pins 4, 6, and 7	-0.3V to $V_{DD} + 0.3V$
pins 1, 2, 3, 8, and 9	-0.3V to 9.5V
Power Dissipation (Note 3)	Internally limited
ESD Susceptibility (Note 4)	2000V

ESD Susceptibility (Note 5)	200V
Junction Temperature	150°C
Thermal Resistance	
θ_{JC} (TS)	4°C/W
θ_{JA} (TS) (Note 3)	20°C/W

Operating Ratings

Temperature Range	$T_{MIN} \leq T_A \leq T_{MAX}$	-40°C ≤ T_A ≤ 85°C
Supply Voltage		9.6V ≤ V_{DD} ≤ 16V

Electrical Characteristics $V_{DD} = 12V$ (Notes 1, 2)

The following specifications apply for $V_{DD} = 12V$, $A_V = 20dB$ (nominal), $R_L = 4\Omega$, and $T_A = 25^\circ C$ unless otherwise noted.

Symbol	Parameter	Conditions	LM4952		Units (Limits)
			Typical (Note 6)	Limit (Notes 7, 8)	
I_{DD}	Quiescent Power Supply Current	$V_{IN} = 0V, I_O = 0A$, No Load	18	35	mA (max)
I_{SD}	Shutdown Current	$V_{SHUTDOWN} = GND$ (Note 9)	55	85	μA (max)
R_{IN}	Amplifier Input Resistance	$V_{DC VOL} = V_{DD}/2$	44		k Ω
		$V_{DC VOL} = GND$	200		k Ω
V_{IN}	Amplifier Input Signal			$V_{DD}/2$	V_{p-p} (max)
V_{SDIH}	Shutdown Voltage Input High			2.0	V (min)
				$V_{DD}/2$	V (max)
V_{SDIL}	Shutdown Voltage Input Low			0.4	V (max)
T_{WU}	Wake-up Time	$C_B = 4.7\mu F$	440		ms
TSD	Thermal Shutdown Temperature		170		°C
P_O	Output Power	$f = 1kHz$, THD+N = 1%	3.1	2.8	W (min)
		THD+N = 10%	3.8		
THD+N	Total Harmonic Distortion + Noise	$P_O = 2.0W_{rms}$, $f = 1kHz$	0.08		%
ϵ_{OS}	Output Noise	A-Weighted Filter, $V_{IN} = 0V$, Input Referred	8		μV
X_{TALK}	Channel Separation	$f_{IN} = 1kHz$, $P_O = 1W$, Input Referred			
		$R_L = 8\Omega$ $R_L = 4\Omega$	78 72		dB
PSRR	Power Supply Rejection Ratio	$V_{RIPPLE} = 200mV_{p-p}$, $f = 1kHz$, Input Referred	89	80	dB (min)
I_{OL}	Output Current Limit	$V_{IN} = 0V$, $R_L = 500m\Omega$	5		A

Electrical Characteristics for Volume Control (Notes 1, 2)

The following specifications apply for $V_{DD} = 12V$, $A_V = 20dB$ (nominal), and $T_A = 25^\circ C$ unless otherwise noted.

Symbol	Parameter	Conditions	LM4952		Units (Limits)
			Typical (Note 6)	Limit (Note 7)	
VOL_{max}	Gain	$V_{DC-VOL} = \text{Full scale, No Load}$	20		dB
VOL_{min}	Gain	$V_{DC-VOL} = +1LSB, \text{No Load}$	-46		dB
A_M	Mute Attenuation	$V_{DC-VOL} = 0V, \text{No Load}$	75	63	dB (min)

Note 1: All voltages are measured with respect to the GND pin, unless otherwise specified.

Note 2: *Absolute Maximum Ratings* indicate limits beyond which damage to the device may occur. *Operating Ratings* indicate conditions for which the device is functional, but do not guarantee specific performance limits. *Electrical Characteristics* state DC and AC electrical specifications under particular test conditions which guarantee specific performance limits. This assumes that the device is within the Operating Ratings. Specifications are not guaranteed for parameters where no limit is given, however, the typical value is a good indication of device performance.

Note 3: The maximum power dissipation must be derated at elevated temperatures and is dictated by T_{JMAX} , θ_{JA} , and the ambient temperature, T_A . The maximum allowable power dissipation is $P_{DMAX} = (T_{JMAX} - T_A) / \theta_{JA}$ or the given in Absolute Maximum Ratings, whichever is lower. For the LM4952 typical application (shown in Figure 1) with $V_{DD} = 12V$, $R_L = 4\Omega$ stereo operation the total power dissipation is 3.65W. $\theta_{JA} = 20^\circ C/W$ for the TO263 package mounted to 16in² heatsink surface area.

Note 4: Human body model, 100pF discharged through a 1.5k Ω resistor.

Note 5: Machine Model, 220pF–240pF discharged through all pins.

Note 6: Typicals are measured at 25°C and represent the parametric norm.

Note 7: Limits are guaranteed to National's AOQL (Average Outgoing Quality Level).

Note 8: Datasheet min/max specification limits are guaranteed by design, test, or statistical analysis.

Note 9: Shutdown current is measured in a normal room environment. The Shutdown pin should be driven as close as possible to GND for minimum shutdown current.

External Components Description Refer to Figure 1

Components	Functional Description
1. C_{IN}	This is the input coupling capacitor. It blocks DC voltage at the amplifier's inverting input. C_{IN} and R_{IN} create a highpass filter. The filter's cutoff frequency is $f_C = 1/(2\pi R_{IN} C_{IN})$. Refer to the SELECTING EXTERNAL COMPONENTS , for an explanation of determining C_{IN} 's value.
2. C_S	The supply bypass capacitor. Refer to the POWER SUPPLY BYPASSING section for information about properly placing, and selecting the value of, this capacitor.
3. C_{BYPASS}	This capacitor filters the half-supply voltage present on the BYPASS pin. Refer to the Application section, SELECTING EXTERNAL COMPONENTS , for information about properly placing, and selecting the value of, this capacitor.

Typical Performance Characteristics $A_v = 20\text{dB}$ and $T_A = 25^\circ\text{C}$, unless otherwise noted.

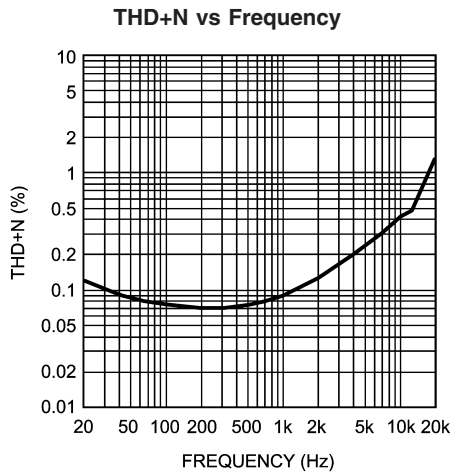

$V_{DD} = 12\text{V}$, $R_L = 4\Omega$,
 $P_{OUT} = 2\text{W}$, $C_{IN} = 1.0\mu\text{F}$

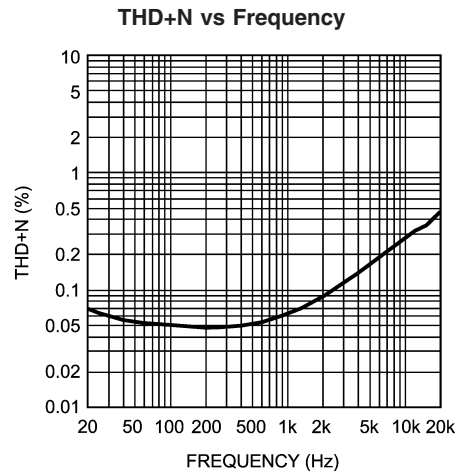

$V_{DD} = 12\text{V}$, $R_L = 8\Omega$,
 $P_{OUT} = 1\text{W}$, $C_{IN} = 1.0\mu\text{F}$

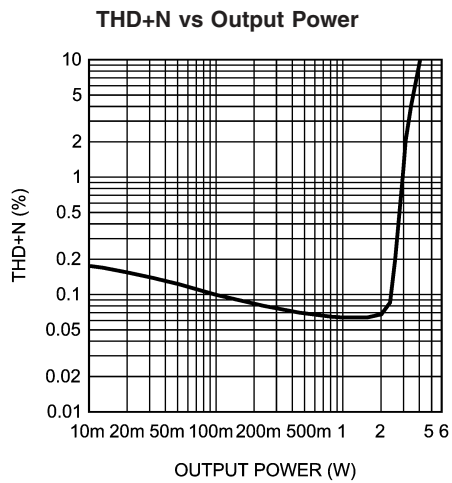

$V_{DD} = 12\text{V}$, $R_L = 4\Omega$,
 $f_{IN} = 1\text{kHz}$

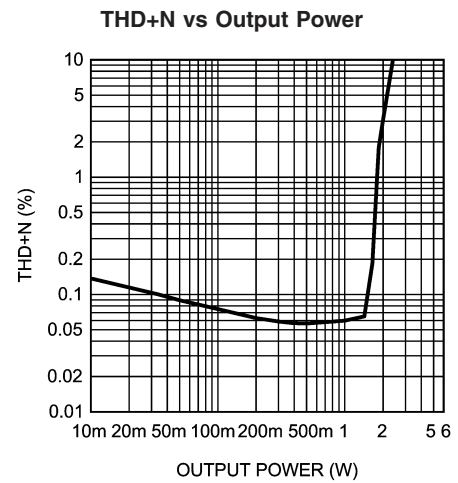

$V_{DD} = 12\text{V}$, $R_L = 8\Omega$,
 $f_{IN} = 1\text{kHz}$

Typical Performance Characteristics $A_V = 20\text{dB}$ and $T_A = 25^\circ\text{C}$, unless otherwise noted.

(Continued)

Output Power vs Power Supply Voltage

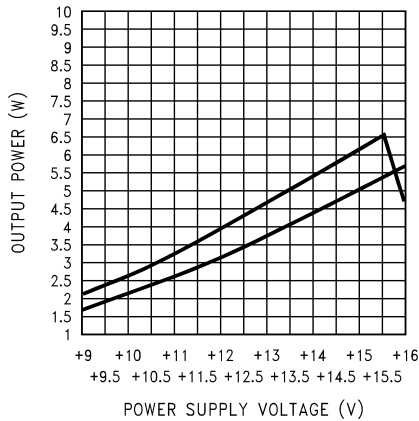

20080909

$R_L = 4\Omega$, $f_{IN} = 1\text{kHz}$
 both channels driven and loaded (average shown),
 at (from top to bottom at 12V):
 THD+N = 10%, THD+N = 1%

Output Power vs Power Supply Voltage

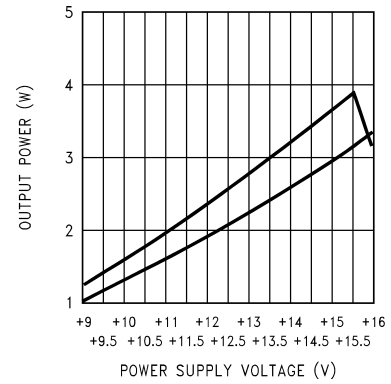

20080910

$R_L = 8\Omega$, $f_{IN} = 1\text{kHz}$
 both channels driven and loaded (average shown),
 at (from top to bottom at 12V):
 THD+N = 10%, THD+N = 1%

Power Supply Rejection vs Frequency

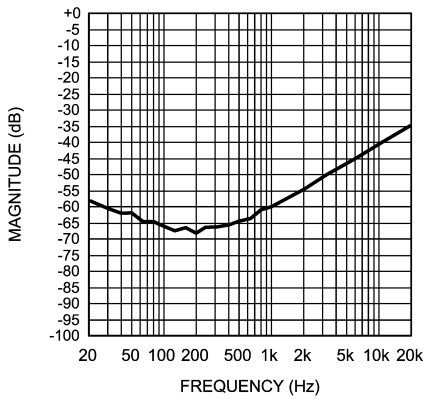

200809F7

$V_{DD} = 12\text{V}$, $R_L = 4\Omega$,
 $V_{RIPPLE} = 200\text{mV}_{p-p}$

Total Power Dissipation vs Load Dissipation

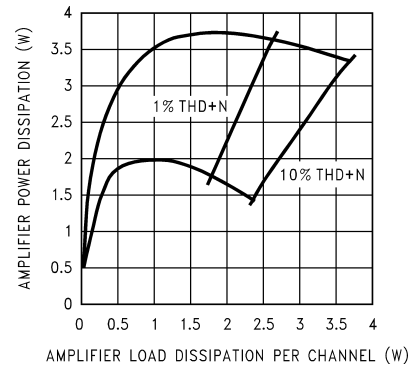

20080913

$V_{DD} = 12\text{V}$, $f_{IN} = 1\text{kHz}$,
 at (from top to bottom at 1W):
 $R_L = 4\Omega$, $R_L = 8\Omega$

Output Power vs Load Resistance

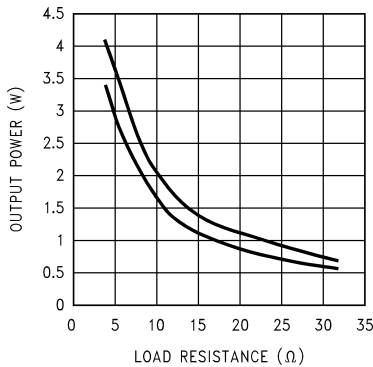

20080914

$V_{DD} = 12\text{V}$, $f_{IN} = 1\text{kHz}$,
 at (from top to bottom at 15Ω):
 THD+N = 10%, THD+N = 1%

Channel-to-Channel Crosstalk vs Frequency

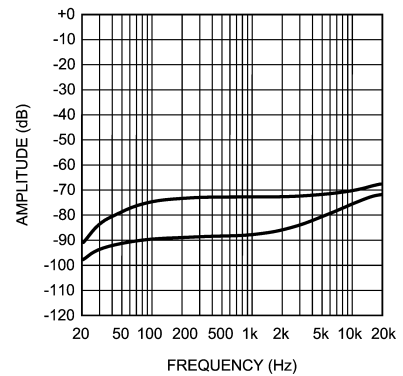

20080915

$V_{DD} = 12\text{V}$, $R_L = 4\Omega$, $P_{OUT} = 1\text{W}$, Input Referred
 at (from top to bottom at 1kHz): V_{INB} driven,
 V_{OUTA} measured, V_{INA} driven, V_{OUTB} measured

Typical Performance Characteristics $A_V = 20\text{dB}$ and $T_A = 25^\circ\text{C}$, unless otherwise noted.

(Continued)

Channel-to-Channel Crosstalk vs Frequency

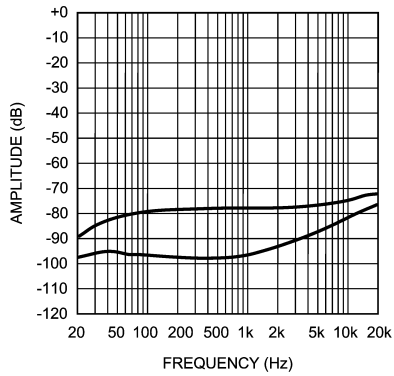

20080916

$V_{DD} = 12\text{V}$, $R_L = 8\Omega$, $P_{OUT} = 1\text{W}$, Input Referred at (from top to bottom at 1kHz): V_{INB} driven, V_{OUTA} measured, V_{INA} driven, V_{OUTB} measured

Amplifier Gain vs DC Volume Voltage

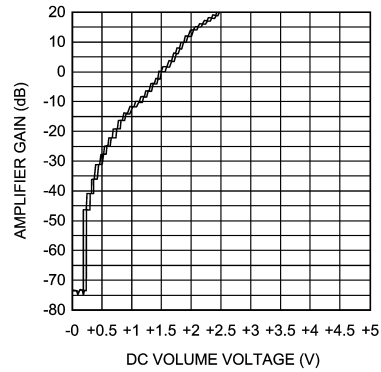

200809F5

$V_{DD} = 12\text{V}$, $R_L = 8\Omega$, at (from top to bottom at 1.5V): Decreasing DC Volume Voltage, Increasing DC Volume Voltage

Amplifier Gain vs Part-to-Part DC Volume Voltage Variation (Five parts)

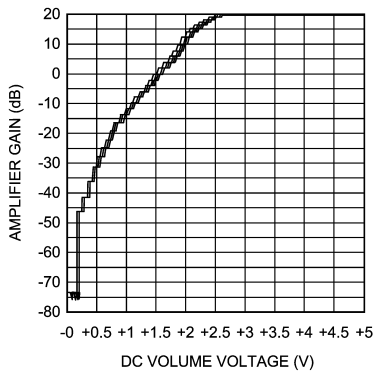

200809F6

$V_{DD} = 12\text{V}$, $R_L = 8\Omega$,

THD+N vs Frequency

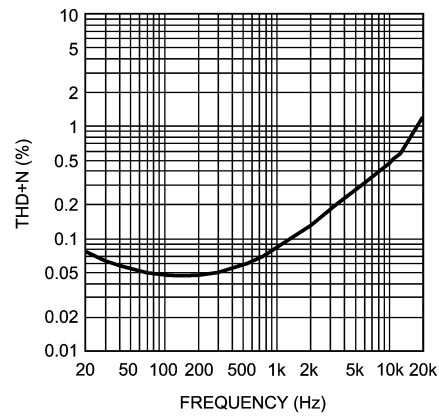

200809G2

$V_{DD} = 9.6\text{V}$, $R_L = 4\Omega$, $P_{OUT} = 1.1\text{W}$, $C_{IN} = 1.0\mu\text{F}$

THD+N vs Frequency

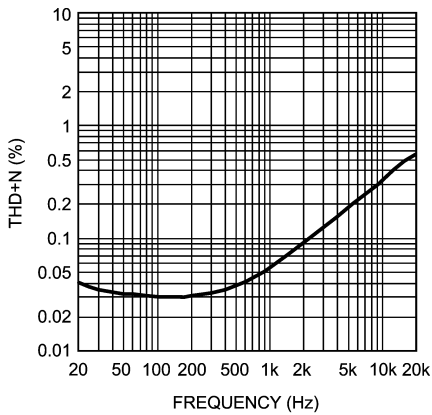

200809G3

$V_{DD} = 9.6\text{V}$, $R_L = 8\Omega$, $P_{OUT} = 850\text{mW}$, $C_{IN} = 1.0\mu\text{F}$

THD+N vs Output Power

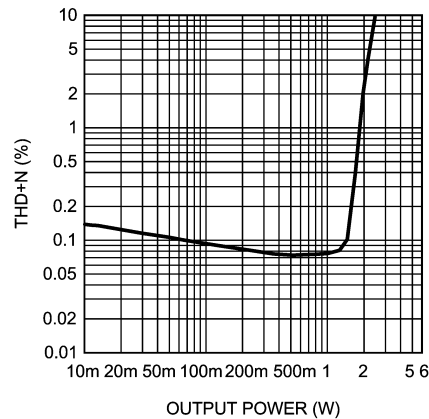

200809G4

$V_{DD} = 9.6\text{V}$, $R_L = 4\Omega$, $f_{IN} = 1\text{kHz}$

Typical Performance Characteristics $A_V = 20\text{dB}$ and $T_A = 25^\circ\text{C}$, unless otherwise noted.

(Continued)

THD+N vs Output Power

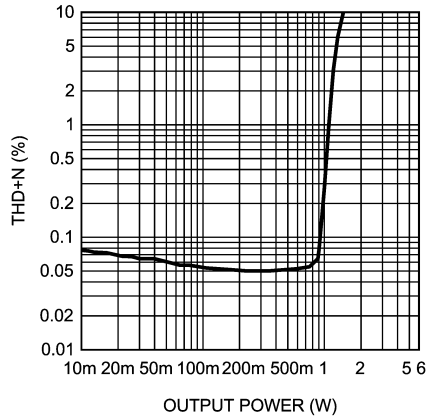

$V_{DD} = 9.6\text{V}$, $R_L = 8\Omega$,
 $f_{IN} = 1\text{kHz}$

200809G5

Total Power Dissipation vs Load Dissipation

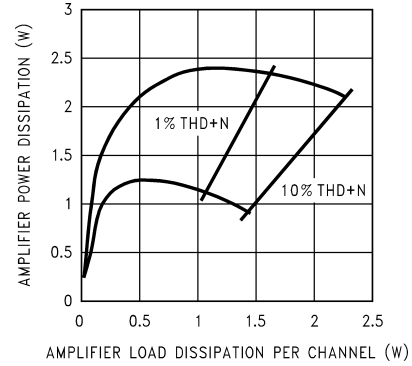

$V_{DD} = 9.6\text{V}$, $f_{IN} = 1\text{kHz}$
at (from top to bottom at 1W):
 $R_L = 4\Omega$, $R_L = 8\Omega$

20080919

Output Power vs Load Resistance

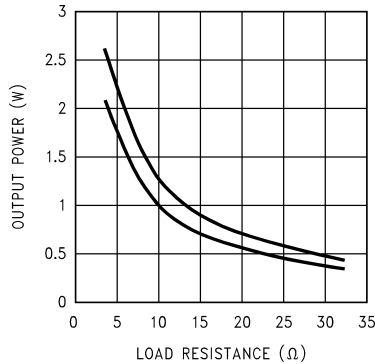

$V_{DD} = 9.6\text{V}$, $f_{IN} = 1\text{kHz}$,
at (from top to bottom at 15Ω):
 $\text{THD+N} = 10\%$, $\text{THD+N} = 1\%$

20080920

Power Supply Rejection vs Frequency

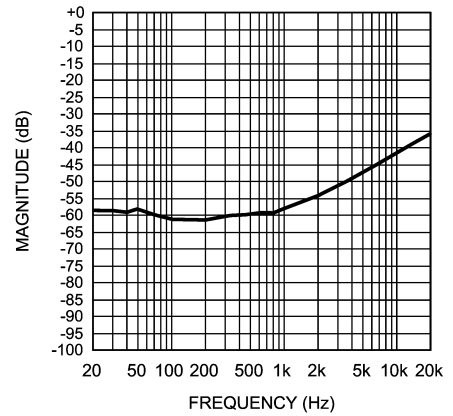

$V_{DD} = 9.6\text{V}$, $R_L = 4\Omega$,
 $V_{RIPPLE} = 200\text{mV}_{P-P}$

200809G6

Channel-to Channel Crosstalk vs Frequency

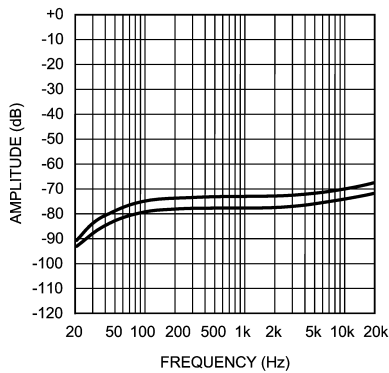

$V_{DD} = 9.6\text{V}$, $R_L = 4\Omega$, $P_{OUT} = 1\text{W}$, Input Referred
at (from top to bottom at 1kHz): V_{INB} driven, V_{OUTA}
measured; V_{INA} driven, V_{OUTB} measured

20080921

Channel-to Channel Crosstalk vs Frequency

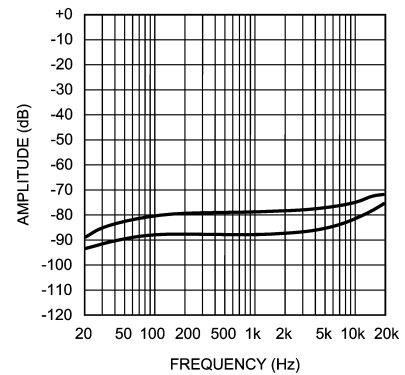

$V_{DD} = 9.6\text{V}$, $R_L = 8\Omega$, $P_{OUT} = 1\text{W}$, Input Referred
at (from top to bottom at 1kHz): V_{INB} driven, V_{OUTA}
measured; V_{INA} driven, V_{OUTB} measured

20080922

Typical Performance Characteristics $A_V = 20\text{dB}$ and $T_A = 25^\circ\text{C}$, unless otherwise noted.

(Continued)

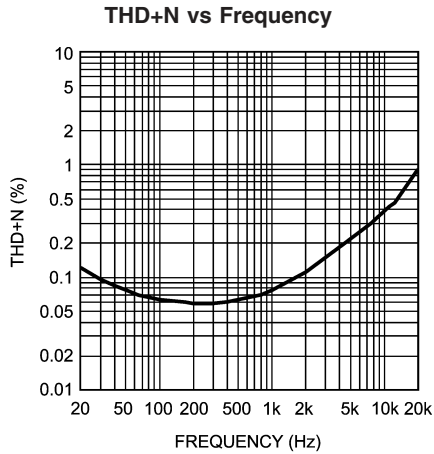

200809G7

$V_{DD} = 14\text{V}$, $R_L = 4\Omega$,
 $P_{OUT} = 2\text{W}$, $C_{IN} = 1.0\mu\text{F}$

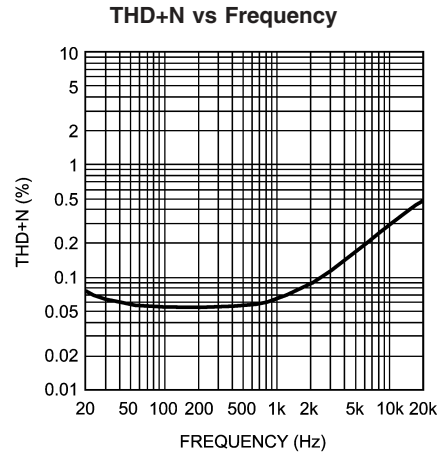

200809G8

$V_{DD} = 14\text{V}$, $R_L = 8\Omega$,
 $P_{OUT} = 1\text{W}$, $C_{IN} = 1.0\mu\text{F}$

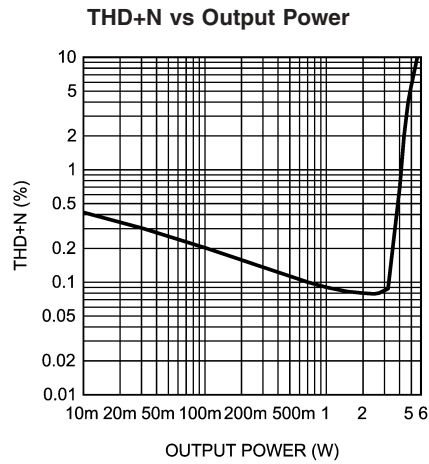

200809G9

$V_{DD} = 14\text{V}$, $R_L = 4\Omega$,
 $f_{IN} = 1\text{kHz}$

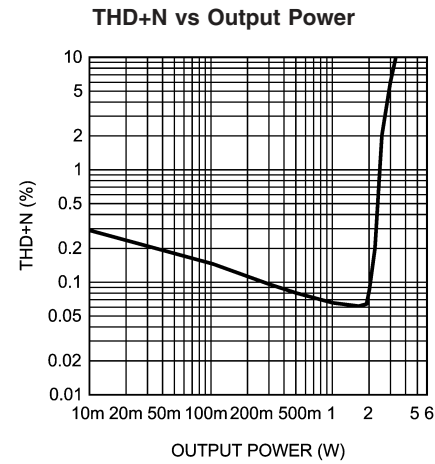

200809H0

$V_{DD} = 14\text{V}$, $R_L = 8\Omega$,
 $f_{IN} = 1\text{kHz}$

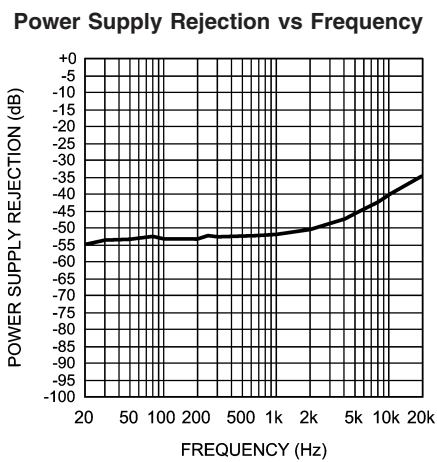

200809H1

$V_{DD} = 14\text{V}$, $R_L = 4\Omega$,
 $V_{RIPPLE} = 200\text{mV}_{P-P}$

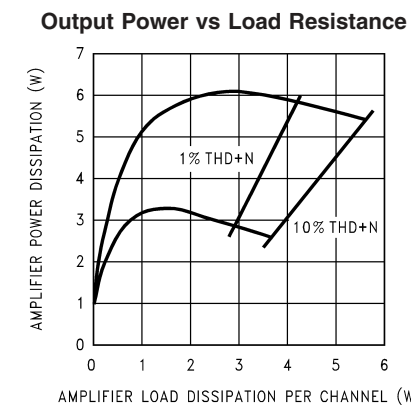

20080925

$V_{DD} = 15\text{V}$, $f_{IN} = 1\text{kHz}$,
at (from top to bottom at 2W):
 $R_L = 4\Omega$, $R_L = 8\Omega$

Typical Performance Characteristics $A_V = 20\text{dB}$ and $T_A = 25^\circ\text{C}$, unless otherwise noted.

(Continued)

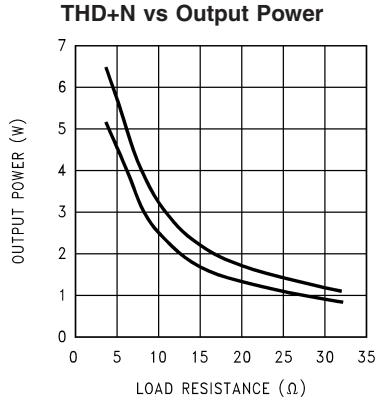

20080926
 $V_{DD} = 15\text{V}$, at (from top to bottom at 15Ω):
 THD+N = 10%, THD+N = 1%, $f_{IN} = 1\text{kHz}$

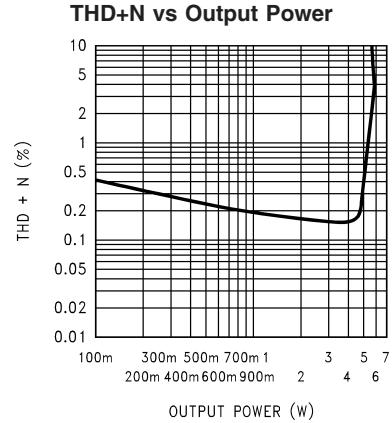

20080927
 $V_{DD} = 16\text{V}$, $R_L = 4\Omega$,
 $f_{IN} = 1\text{kHz}$

Channel-to-Channel Crosstalk vs Frequency

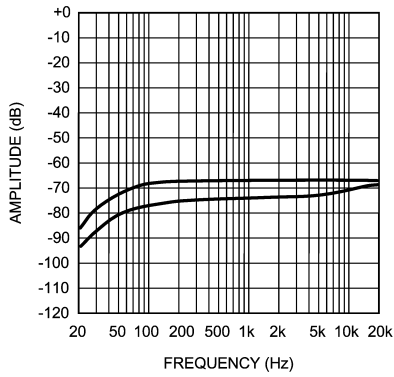

20080928
 $V_{DD} = 16\text{V}$, $R_L = 4\Omega$, $P_{OUT} = 1\text{W}$, Input Referred
 at (from top to bottom at 1kHz): V_{INB} driven, V_{OUTA}
 measured; V_{INA} driven, V_{OUTB} measured

Channel-to-Channel Crosstalk vs Frequency

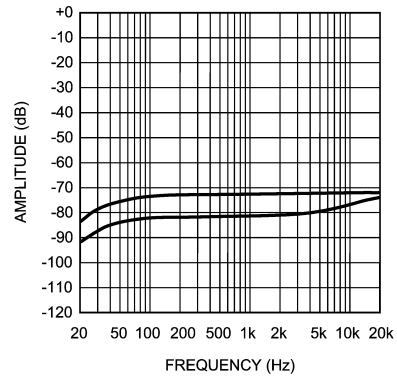

20080929
 $V_{DD} = 16\text{V}$, $R_L = 8\Omega$, $P_{OUT} = 1\text{W}$, Input Referred
 at (from top to bottom at 1kHz): V_{INB} driven, V_{OUTA}
 measured; V_{INA} driven, V_{OUTB} measured

Power Supply Current vs Power Supply Voltage

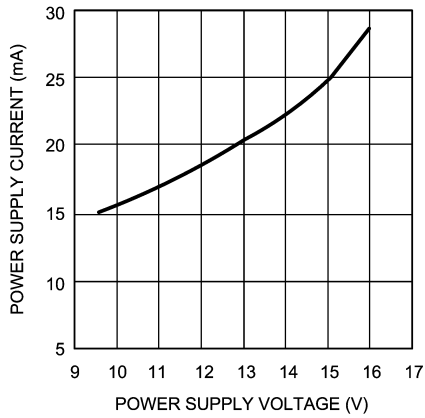

200809H2
 $R_L = 4\Omega$,
 $V_{IN} = 0\text{V}$, $R_{SOURCE} = 50\Omega$

Clipping Voltage vs Power Supply Voltage

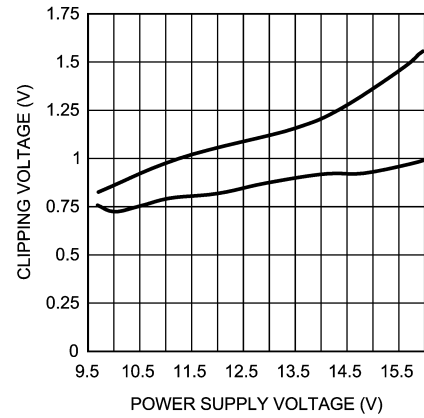

20080931
 $R_L = 4\Omega$, $f_{IN} = 1\text{kHz}$
 at (from top to bottom at 12.5V):
 positive signal swing, negative signal swing

Typical Performance Characteristics $A_V = 20\text{dB}$ and $T_A = 25^\circ\text{C}$, unless otherwise noted.

(Continued)

Clipping Voltage vs Power Supply Voltage

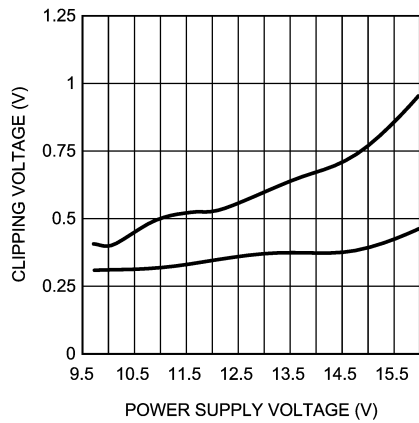

$R_L = 8\Omega$, $f_{IN} = 1\text{kHz}$
 at (from to bottom at 12.5V):
 positive signal swing, negative signal swing

Power Dissipation vs Ambient Temperature

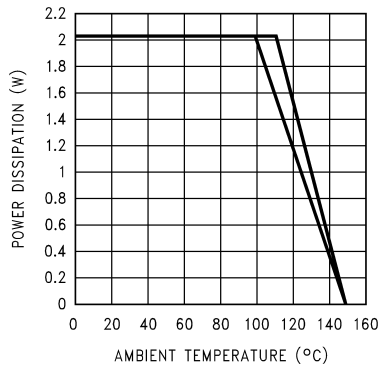

$V_{DD} = 12\text{V}$, $R_L = 8\Omega$, $f_{IN} = 1\text{kHz}$,
 (from to bottom at 120°C): 16in² copper plane heatsink
 area, 8in² copper plane heatsink area

Power Dissipation vs Ambient Temperature

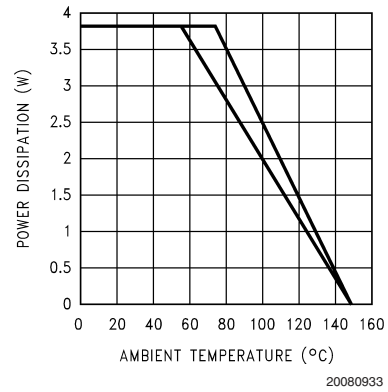

$V_{DD} = 12\text{V}$, $R_L = 4\Omega$ (SE), $f_{IN} = 1\text{kHz}$,
 (from to bottom at 80°C): 16in² copper plane heatsink
 area, 8in² copper plane heatsink area

Application Information

HIGH VOLTAGE BOOMER WITH INCREASED OUTPUT POWER

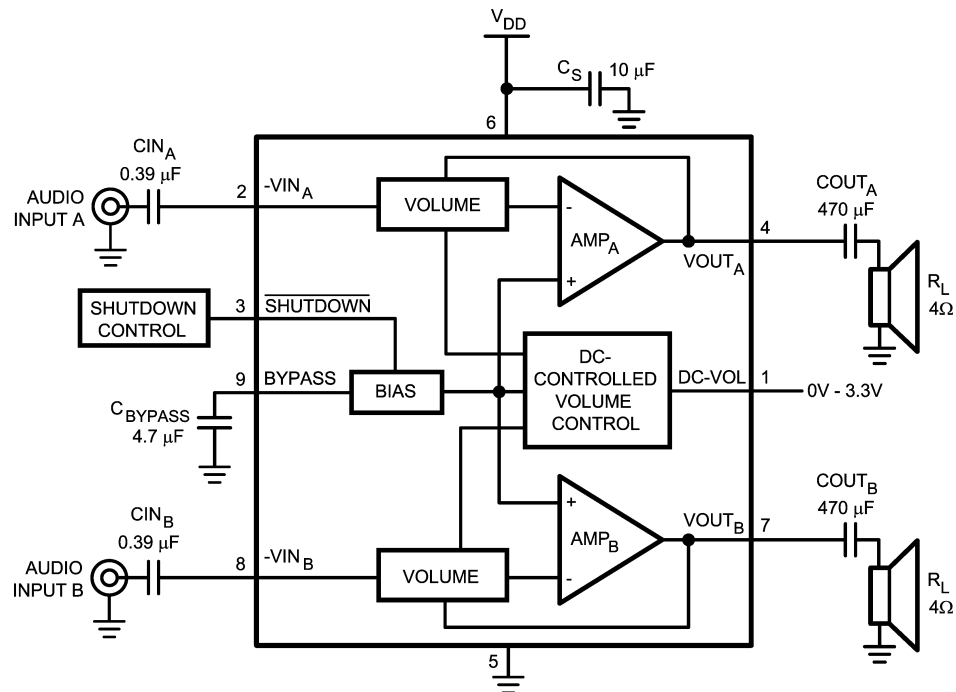

200809E8

FIGURE 2. Typical LM4952 SE Application Circuit

Unlike previous 5V Boomer® amplifiers, the LM4952 is designed to operate over a power supply voltages range of 9.6V to 16V. Operating on a 12V power supply, the LM4952 will deliver 3.8W into a 4Ω SE load with no more than 10% THD+N.

POWER DISSIPATION

Power dissipation is a major concern when designing a successful single-ended or bridged amplifier. Equation (2) states the maximum power dissipation point for a single-ended amplifier operating at a given supply voltage and driving a specified output load.

$$P_{\text{DMAX-SE}} = (V_{\text{DD}})^2 / (2\pi^2 R_L): \text{ Single Ended} \quad (1)$$

The LM4952's dissipation is twice the value given by Equation (2) when driving two SE loads. For a 12V supply and two 4Ω SE loads, the LM4952's dissipation is 1.82W.

The maximum power dissipation point given by Equation (1) must not exceed the power dissipation given by Equation (2):

$$P_{\text{DMAX}}' = (T_{\text{JMAX}} - T_A) / \theta_{\text{JA}} \quad (2)$$

The LM4952's $T_{\text{JMAX}} = 150^\circ\text{C}$. In the TS package, the LM4952's θ_{JA} is 20°C/W when the metal tab is soldered to a copper plane of at least 16in^2 . This plane can be split be-

tween the top and bottom layers of a two-sided PCB. Connect the two layers together under the tab with a 5x5 array of vias. At any given ambient temperature T_A , use Equation (2) to find the maximum internal power dissipation supported by the IC packaging. Rearranging Equation (2) and substituting P_{DMAX} for P_{DMAX}' results in Equation (3). This equation gives the maximum ambient temperature that still allows maximum stereo power dissipation without violating the LM4952's maximum junction temperature.

$$T_A = T_{\text{JMAX}} - P_{\text{DMAX-SE}}\theta_{\text{JA}} \quad (3)$$

For a typical application with a 12V power supply and an SE 4Ω load, the maximum ambient temperature that allows maximum stereo power dissipation without exceeding the maximum junction temperature is approximately 77°C for the TS package.

$$T_{\text{JMAX}} = P_{\text{DMAX-MONOBTL}}\theta_{\text{JA}} + T_A \quad (4)$$

Equation (4) gives the maximum junction temperature T_{JMAX} . If the result violates the LM4952's 150°C , reduce the maximum junction temperature by reducing the power supply voltage or increasing the load resistance. Further allowance should be made for increased ambient temperatures.

The above examples assume that a device is operating around the maximum power dissipation point. Since internal

Application Information (Continued)

power dissipation is a function of output power, higher ambient temperatures are allowed as output power or duty cycle decreases.

If the result of Equation (1) is greater than that of Equation (2), then decrease the supply voltage, increase the load impedance, or reduce the ambient temperature. Further, ensure that speakers rated at a nominal 4Ω do not fall below 3Ω . If these measures are insufficient, a heat sink can be added to reduce θ_{JA} . The heat sink can be created using additional copper area around the package, with connections to the ground pins, supply pin and amplifier output pins. Refer to the **Typical Performance Characteristics** curves for power dissipation information at lower output power levels.

POWER SUPPLY VOLTAGE LIMITS

Continuous proper operation is ensured by never exceeding the voltage applied to any pin, with respect to ground, as listed in the Absolute Maximum Ratings section.

POWER SUPPLY BYPASSING

As with any power amplifier, proper supply bypassing is critical for low noise performance and high power supply rejection. Applications that employ a voltage regulator typically use a $10\mu\text{F}$ in parallel with a $0.1\mu\text{F}$ filter capacitors to stabilize the regulator's output, reduce noise on the supply line, and improve the supply's transient response. However, their presence does not eliminate the need for a local $10\mu\text{F}$ tantalum bypass capacitance connected between the LM4952's supply pins and ground. Do not substitute a ceramic capacitor for the tantalum. Doing so may cause oscillation. Keep the length of leads and traces that connect capacitors between the LM4952's power supply pin and ground as short as possible.

BYPASS PIN BYPASSING

Connecting a $4.7\mu\text{F}$ capacitor, C_{BYPASS} , between the BYPASS pin and ground improves the internal bias voltage's stability and improves the amplifier's PSRR. The PSRR improvements increase as the bypass pin capacitor value increases. Too large, however, increases turn-on time. The selection of bypass capacitor values, especially C_{BYPASS} , depends on desired PSRR requirements, click and pop performance (as explained in the section, **SELECTING EXTERNAL COMPONENTS**), system cost, and size constraints.

MICRO-POWER SHUTDOWN

The LM4952 features an active-low micro-power shutdown mode. When active, the LM4952's micro-power shutdown feature turns off the amplifier's bias circuitry, reducing the supply current. The low $55\mu\text{A}$ typical shutdown current is achieved by applying a voltage to the SHUTDOWN pin that is as near to GND as possible. A voltage that is greater than GND may increase the shutdown current.

There are a few methods to control the micro-power shutdown. These include using a single-pole, single-throw switch (SPST), a microprocessor, or a microcontroller. Figure 3 shows a simple switch-based circuit that can be used to control the LM4952's shutdown function. Select normal amplifier operation by closing the switch. Opening the switch applies GND to the SHUTDOWN pin, activating micro-power shutdown. The switch and resistor guarantee that the SHUTDOWN pin will not float. This prevents unwanted state

changes. In a system with a microprocessor or a microcontroller, use a digital output to apply the active-state voltage to the SHUTDOWN pin.

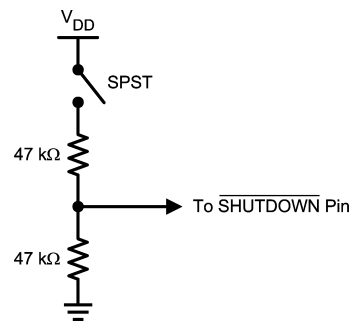

200809H3

FIGURE 3. Simple switch and voltage divider generates shutdown control signal

DC VOLUME CONTROL

The LM4952 has an internal stereo volume control whose setting is a function of the DC voltage applied to the DC VOL input pin.

The LM4952 volume control consists of 31 steps that are individually selected by a variable DC voltage level on the volume control pin. As shown in Figure 4, the range of the steps, controlled by the DC voltage, is 20dB to -46dB.

The gain levels are 1dB/step from 20dB to 14dB, 2dB/step from 14dB to -16dB, 3dB/step from -16dB to -27dB, 4dB/step from -27dB to -31dB, 5dB/step from -31dB to -46dB.

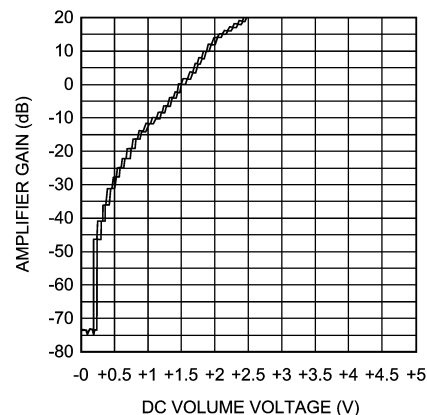

200809F5

FIGURE 4. Volume control response

Like all volume controls, the LM4952's internal volume control is set while listening to an amplified signal that is applied to an external speaker. The actual voltage applied to the DC VOL input pin is a result of the volume a listener desires. As such, the volume control is designed for use in a feedback system that includes human ears and preferences. This feedback system operates quite well without the need for accurate gain. The user simply sets the volume to the desired level as determined by their ear, without regard to the actual DC voltage that produces the volume. Therefore, the accuracy of the volume control is not critical, as long as volume changes monotonically and step size is small enough to reach a desired volume that is not too loud or too

Application Information (Continued)

soft. Since the gain is not critical, there may be a volume variation from part-to-part even with the same applied DC volume control voltage. The gain of a given LM4952 can be set with fixed external voltage, but another LM4952 may require a different control voltage to achieve the same gain. Figure 5 is a curve showing the volume variation of five typical LM4952s as the voltage applied to the DC VOL input pin is varied. For gains between -20dB and $+16\text{dB}$, the typical part-to-part variation is typically $\pm 1\text{dB}$ for a given control voltage.

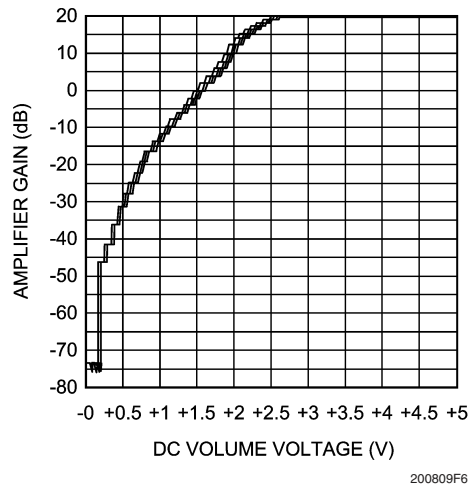
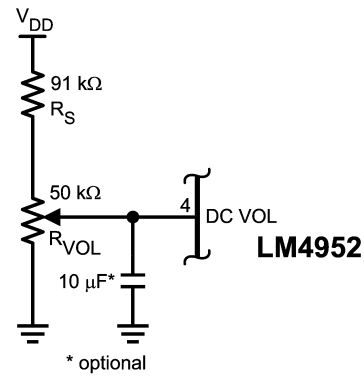

FIGURE 5. Typical part-to-part gain variation as a function of DC Vol control voltage

VOLUME CONTROL VOLTAGE GENERATION

Figure 6 shows a simple circuit that can be used to create an adjustable DC control voltage that is applied to the DC Vol input. The $91\text{k}\Omega$ series resistor and the $50\text{k}\Omega$ potentiometer create a voltage divider between the supply voltage, V_{DD} , and GND. The series resistor's value assumes a 12V power supply voltage. The voltage present at the node between the series resistor and the top of the potentiometer need only be a nominal value of 3.5V and must not exceed 9.5V , as stated in the LM4952's Absolute Maximum Ratings.



20080966

FIGURE 6. Typical circuit used for DC voltage volume control. Capacitor connected to DC VOL pin minimizes voltage fluctuation when using unregulated supplies that could cause changes in perceived volume setting

UNREGULATED POWER SUPPLIES AND THE DC VOL CONTROL

As an amplifier's output power increases, the current that flows from the power supply also increases. If an unregulated power supply is used, its output voltage can decrease ("droop" or "sag") as this current increases. It is not uncommon for an unloaded 15V power supply connected to the LM4952 to sag by as much as 2V when the amplifier is drawing 1A to 2A while driving 4Ω stereo loads to full power dissipation. Figure 7 is an oscilloscope photo showing an unregulated power supply's voltage sag while powering an LM4952 that is driving 4Ω stereo loads. The amplifier's input is a typical music signal supplied by a CD player. As shown, the sag can be quite significant.

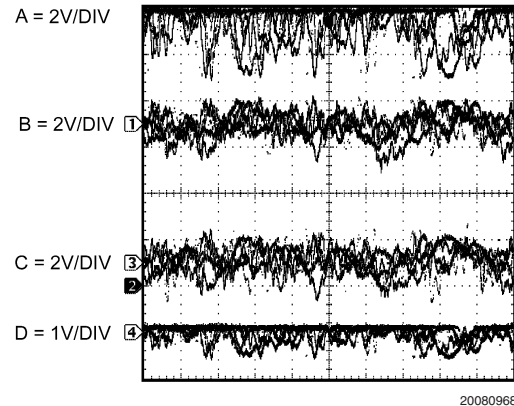

20080968

FIGURE 7. LM4952 operating on an unregulated 12V (nominal) power supply. Wave forms shown include V_{DD} (Trace A), $V_{OUT A}$ (Trace B), $V_{OUT B}$ (Trace C), and the DC voltage applied to the DC VOL pin (Trace D)

This sagging supply voltage presents a potential problem when the voltage that drives the DC Vol pin is derived from the voltage supplied by an unregulated power supply. This is the case for the typical volume control circuit (a $50\text{k}\Omega$ potentiometer in series with a $91\text{k}\Omega$ resistor) shown in Figure 6. The potentiometer's wiper is connected to the DC Vol pin. With this circuit, power supply voltage fluctuations will be

Application Information (Continued)

seen by the DC Vol input. Though attenuated by the voltage divider action of the potentiometer and the series resistor, these fluctuations may cause perturbations in the perceived volume. An easy and simple solution that suppresses these perturbations is a $10\mu\text{F}$ capacitor connected between the DC Vol pin and ground. See the result of this capacitor in Figure 8. This capacitance can also be supplemented with bulk capacitance in the range of $1000\mu\text{F}$ to $10,000\mu\text{F}$ connected to the unregulated power supply's output. Figure 10 shows how this bulk capacitance minimizes fluctuations on V_{DD} .

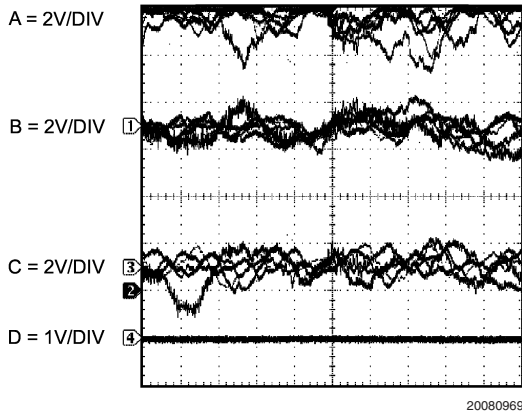

FIGURE 8. Same conditions and waveforms as shown in Figure 7, except that a $10\mu\text{F}$ capacitor has been connected between the DC VOL pin and GND (Trace D)

If space constraints preclude the use of a $10\mu\text{F}$ capacitor connected to the DC Vol pin or large amounts of bulk supply capacitance, or if more resistance to the fluctuations is desired, using an LM4040-4.1 voltage reference shown in Figure 9 is recommended. The value of the $91\text{k}\Omega$ resistor, already present in the typical volume applications circuit, should be changed to $62\text{k}\Omega$. This sets the LM4040-4.1's bias current at $125\mu\text{A}$ when using a nominal 12V supply, well within the range of current needed by this reference.

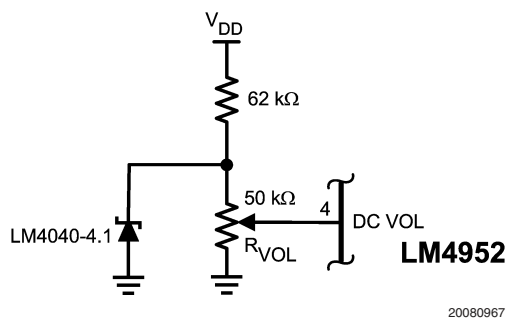

FIGURE 9. Using an LM4040-4.1 to set the maximum DC volume control voltage and attenuate power supply variations when using unregulated supplies that would otherwise perturb the volume setting.

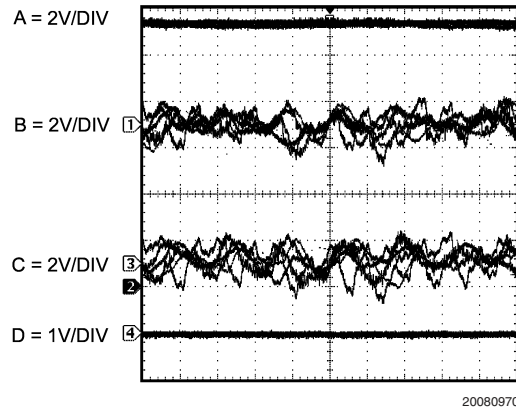

FIGURE 10. Same conditions and waveforms as shown in Figure 8, except that a $4700\mu\text{F}$ capacitor has been connected between the V_{DD} pin and GND (Trace A)

SELECTING EXTERNAL COMPONENTS

Input Capacitor Value Selection

Two quantities determine the value of the input coupling capacitor: the lowest audio frequency that requires amplification and desired output transient suppression.

The amplifier's input resistance and the input capacitor (C_{IN}) produce a high pass filter cutoff frequency that is found using Equation (5).

$$f_{\text{CIN}} = 1/(2\pi R_{\text{IN}} C_{\text{IN}}) \quad (5)$$

As an example when using a speaker with a low frequency limit of 50Hz and based on the LM4952's $44\text{k}\Omega$ nominal minimum input resistance, C_{IN} , using Equation (5) is $0.072\mu\text{F}$. The $0.39\mu\text{F}$ C_{INA} shown in Figure 2 allows the LM4952 to drive high efficiency, full range speaker whose response extends below 30Hz .

Similarly, the output coupling capacitor and the load impedance also form a high pass filter. The cutoff frequency formed by these two components is found using Equation (6)

$$f_{\text{COUT}} = 1/(2\pi R_{\text{LOAD}} C_{\text{OUT}}) \quad (6)$$

Expanding on the example above and assuming a nominal speaker impedance of 4Ω , response below 30Hz is assured if the output coupling capacitors have a value, using Equation (6), greater than $1330\mu\text{F}$.

Bypass Capacitor Value

Besides minimizing the input capacitor size, careful consideration should be paid to value of C_{BYPASS} , the capacitor connected to the BYPASS pin. Since C_{BYPASS} determines how fast the LM4952 settles to quiescent operation, its value is critical when minimizing turn-on pops. The slower the LM4952's outputs ramp to their quiescent DC voltage (nominally $V_{\text{DD}}/2$), the smaller the turn-on pop. Choosing C_{BYPASS} equal to $4.7\mu\text{F}$ along with a small value of C_{IN} (in the range of $0.1\mu\text{F}$ to $0.39\mu\text{F}$) produces a click-less and pop-less shutdown function. As discussed above, choosing C_{IN} no larger than necessary for the desired bandwidth helps minimize clicks and pops.

Routing Input and BYPASS Capacitor Grounds

Optimizing the LM4952's low distortion performance is easily accomplished by connecting the input signal's ground reference directly to the TO263's grounded tab connection. In like

Application Information (Continued)

manner, the ground lead of the capacitor connected between the BYPASS pin and GND should also be connected to the package's grounded tab.

OPTIMIZING CLICK AND POP REDUCTION PERFORMANCE

The LM4952 contains circuitry that eliminates turn-on and shutdown transients ("clicks and pops"). For this discussion, turn-on refers to either applying the power supply voltage or when the micro-power shutdown mode is deactivated.

As the $V_{DD}/4$ voltage present at the BYPASS pin ramps to its final value, the LM4952's internal amplifiers are muted. Once the voltage at the BYPASS pin reaches $V_{DD}/4$, the amplifiers are unmuted.

The gain of the internal amplifiers remains unity until the voltage on the bypass pin reaches $V_{DD}/4$. As soon as the voltage on the bypass pin is stable, the device becomes fully operational and the amplifier outputs are reconnected to their respective output pins.

In order to eliminate "clicks and pops", all capacitors must be discharged before turn-on. Rapidly switching V_{DD} may not allow the capacitors to fully discharge, which may cause "clicks and pops".

There is a relationship between the value of C_{IN} and C_{BYPASS} that ensures minimum output transient when power is applied or the shutdown mode is deactivated. Best performance is achieved by selecting a C_{BYPASS} value that is greater than twelve times C_{IN} 's value.

RECOMMENDED PRINTED CIRCUIT BOARD LAYOUT

Figure 9 through Figure 11 show the recommended two-layer PC board layout that is optimized for the TO263-packaged, SE-configured LM4952 and associated external components. These circuits are designed for use with an external 12V supply and 4Ω(min)(SE) speakers.

These circuit boards are easy to use. Apply 12V and ground to the board's V_{DD} and GND pads, respectively. Connect a speaker between the board's OUT_A and OUT_B outputs and respective GND pins.

Demonstration Board Layout

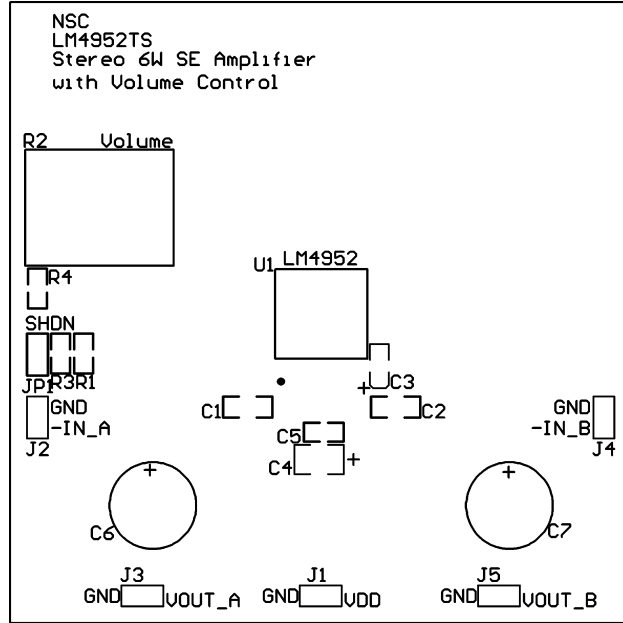

200809F2

FIGURE 11. Recommended TS SE PCB Layout:
Top Silkscreen

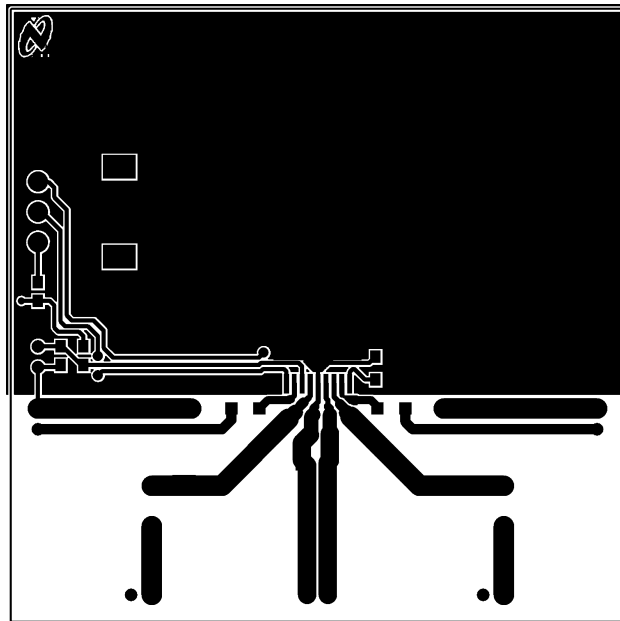

200809F4

FIGURE 12. Recommended TS SE PCB Layout:
Top Layer

Demonstration Board Layout (Continued)

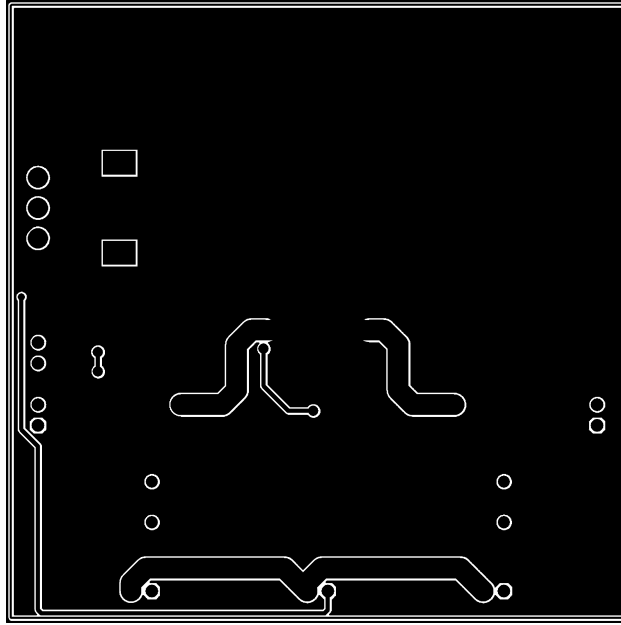

200809F3

**FIGURE 13. Recommended TS SE PCB Layout:
Bottom Layer**

Physical Dimensions inches (millimeters)

unless otherwise noted

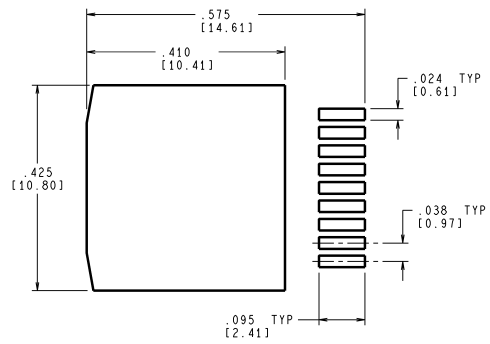
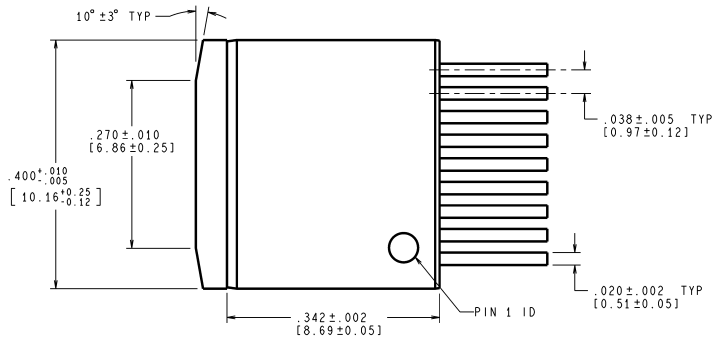

RECOMMENDED LAND PATTERN

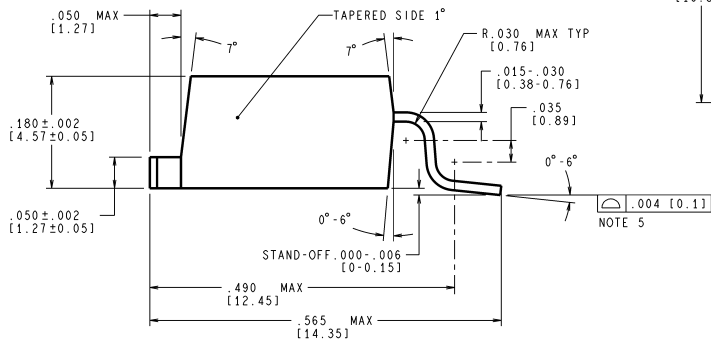

CONTROLLING DIMENSION: INCH
VALUES IN [] ARE IN MILLIMETERS

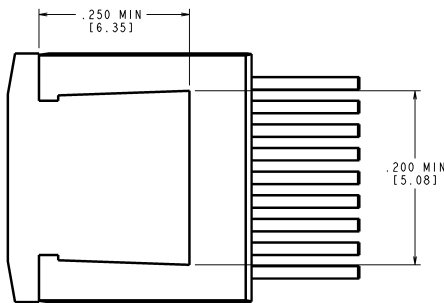

TS9A (Rev A)

Order Number LM4952TS
NS Package Number TS9A

Notes

LIFE SUPPORT POLICY

NATIONAL'S PRODUCTS ARE NOT AUTHORIZED FOR USE AS CRITICAL COMPONENTS IN LIFE SUPPORT DEVICES OR SYSTEMS WITHOUT THE EXPRESS WRITTEN APPROVAL OF THE PRESIDENT AND GENERAL COUNSEL OF NATIONAL SEMICONDUCTOR CORPORATION. As used herein:

1. Life support devices or systems are devices or systems which, (a) are intended for surgical implant into the body, or (b) support or sustain life, and whose failure to perform when properly used in accordance with instructions for use provided in the labeling, can be reasonably expected to result in a significant injury to the user.
2. A critical component is any component of a life support device or system whose failure to perform can be reasonably expected to cause the failure of the life support device or system, or to affect its safety or effectiveness.

BANNED SUBSTANCE COMPLIANCE

National Semiconductor certifies that the products and packing materials meet the provisions of the Customer Products Stewardship Specification (CSP-9-111C2) and the Banned Substances and Materials of Interest Specification (CSP-9-111S2) and contain no "Banned Substances" as defined in CSP-9-111S2.



National Semiconductor
Americas Customer
Support Center
Email: new.feedback@nsc.com
Tel: 1-800-272-9959

www.national.com

National Semiconductor
Europe Customer Support Center
Fax: +49 (0) 180-530 85 86
Email: europe.support@nsc.com
Deutsch Tel: +49 (0) 69 9508 6208
English Tel: +44 (0) 870 24 0 2171
Français Tel: +33 (0) 1 41 91 8790

National Semiconductor
Asia Pacific Customer
Support Center
Email: ap.support@nsc.com

National Semiconductor
Japan Customer Support Center
Fax: 81-3-5639-7507
Email: jpn.feedback@nsc.com
Tel: 81-3-5639-7560