

3. General Use FC, FA, FB



■ Features

- General use wire wound, resin molded chip inductor.
- Capable of being Re-flow or flow soldered.
- Wide line-up from 2520 to 4532 case sizes.
- Good for mounting.

■ Recommended Applications

- AV equipment, Wireless communication equipment and various types of general electronic equipment.

■ Explanation of Part Numbers

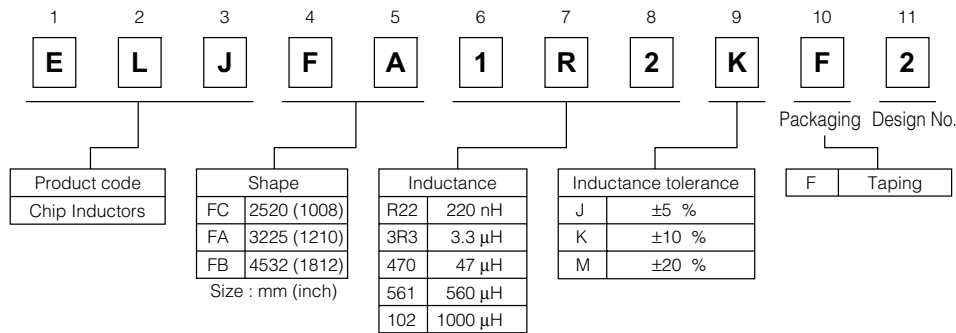

■ Storage Conditions

- Package : Normal temperature (−5 to 35 °C), normal humidity (85 %RH max.), shall not be exposed to direct sunlight and harmful gases and care should be taken so as not to cause dew.
- Operating Temperature : −20 to +85 °C

■ Storage Period

- Solderability may be reduced due to the conditions of high temperature and high humidity which causes the oxidation of tin-plated terminals. Even if storage conditions are within specified limits, solderability may be reduced with the passage of time. Therefore, please control the storage conditions and try to use the product within 6 months of receipt.

■ Packaging Methods Please see Page 127

■ Soldering Conditions Please see Page 128

■ Safety Precautions Please see Page 129

Design and specifications are each subject to change without notice. Ask factory for the current technical specifications before purchase and/or use. Should a safety concern arise regarding this product, please be sure to contact us immediately.

00 Sep. 2010

■ FC Type 2520 (1008)

● Dimensions in mm (not to scale)

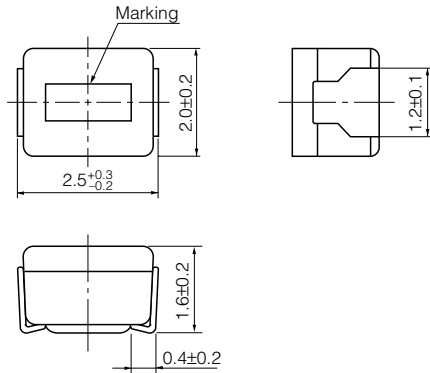

● Recommended Land Pattern in mm (not to scale)



■ Standard Packing Quantity

● 2000 pcs./Reel

■ Standard Parts

Part No.	Inductance			Q		SRF *1 (MHz) min.	R _{DC} *2 (Ω) max.	DC Current (mA) max.				
	(μH)	Tolerance (%)	Test Freq. (MHz)	min.	Test Freq. (MHz)							
ELJFCR22□F	0.22	M : ±20 % or K : ±10 %	25.2		25.2	230	0.70	190				
ELJFCR27□F	0.27					210	0.75	180				
ELJFCR33□F	0.33					190	0.85	170				
ELJFCR39□F	0.39					175	0.95	160				
ELJFCR47□F	0.47					160	1.00	155				
ELJFCR56□F	0.56					155	1.10	150				
ELJFCR68□F	0.68					135	1.25	140				
ELJFCR82□F	0.82					125	1.40	130				
ELJFC1R0□F	1.0					K : ±10 % or J : ±5 %	7.96	25	7.96	115	0.65	195
ELJFC1R2□F	1.2									100	0.75	180
ELJFC1R5□F	1.5	90	0.85	170								
ELJFC1R8□F	1.8	85	0.95	160								
ELJFC2R2□F	2.2	80	1.05	155								
ELJFC2R7□F	2.7	75	1.20	145								
ELJFC3R3□F	3.3	65	1.30	135								
ELJFC3R9□F	3.9	60	1.40	130								
ELJFC4R7□F	4.7	55	1.55	125								
ELJFC5R6□F	5.6	50	1.75	120								
ELJFC6R8□F	6.8	45	1.95	115								
ELJFC8R2□F	8.2	40	2.20	105								
ELJFC100□F	10	32	3.70	80								
ELJFC120□F	12	30	4.10	75								
ELJFC150□F	15	28	5.00	70								
ELJFC180□F	18	25	5.40	65								
ELJFC220□F	22	22	6.00	60								
ELJFC270□F	27	21	6.30	115								
ELJFC330□F	33	20	7.10	110								
ELJFC390□F	39	18	9.50	90								
ELJFC470□F	47	17	11.0	80								
ELJFC560□F	56	16	12.1	75								
ELJFC680□F	68	15	16.6	70								
ELJFC820□F	82	13	19.0	65								
ELJFC101□F	100	12	21.0	60								
		0.796	15	0.796								

□ : Symbol of Tolerance *1 : Self Resonant Frequency *2 : DC Resistance

■ FA Type 3225 (1210)

● Dimensions in mm (not to scale)

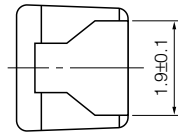
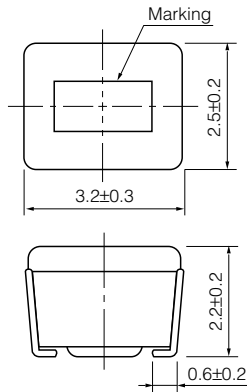

● Recommended Land Pattern in mm (not to scale)

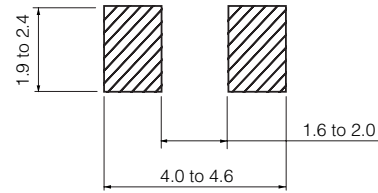

■ Standard Packing Quantity

● 2000 pcs./Reel

■ Standard Parts

Part No.	Inductance			Q		SRF *1 (MHz) min.	R _{DC} *2 (Ω) max.	DC Current (mA) max.
	(μH)	Tolerance (%)	Test Freq. (MHz)	min.	Test Freq. (MHz)			
ELJFAR22□F2	0.22	M : ±20 % or K : ±10 %	25.2	25	25.2	230	0.29	360
ELJFAR27□F2	0.27					210	0.32	345
ELJFAR33□F2	0.33					190	0.35	330
ELJFAR39□F2	0.39					175	0.39	305
ELJFAR47□F2	0.47					160	0.44	290
ELJFAR56□F2	0.56					150	0.49	275
ELJFAR68□F2	0.68					135	0.55	260
ELJFAR82□F2	0.82					125	0.61	245
ELJFA1R0□F2	1.0					K : ±10 % or J : ±5 %	7.96	30
ELJFA1R2□F2	1.2	100	0.75	215				
ELJFA1R5□F	1.5	90	0.75	210				
ELJFA1R8□F	1.8	85	0.82	200				
ELJFA2R2□F	2.2	80	0.95	190				
ELJFA2R7□F	2.7	75	1.1	180				
ELJFA3R3□F	3.3	65	1.2	180				
ELJFA3R9□F	3.9	60	1.3	175				
ELJFA4R7□F	4.7	55	1.5	165				
ELJFA5R6□F	5.6	50	1.6	160				
ELJFA6R8□F	6.8	45	1.8	150				
ELJFA8R2□F	8.2	40	2.0	140				
ELJFA100□F	10	36	2.1	140				
ELJFA120□F	12	33	2.5	125				
ELJFA150□F	15	30	2.8	120				
ELJFA180□F	18	27	3.3	110				
ELJFA220□F	22	25	3.7	105				
ELJFA270□F	27	22	5.0	90				
ELJFA330□F	33	20	5.6	85				
ELJFA390□F	39	20	6.4	80				
ELJFA470□F	47	15	7.0	75				
ELJFA560□F	56	15	8.0	70				
ELJFA680□F	68	15	9.0	65				
ELJFA820□F	82	10	10.0	60				
ELJFA101□F	100	10	10.0	60				
ELJFA121□F	120	10	11.0	55				
ELJFA151□F	150	8	15.0	50				
ELJFA181□F	180	7	17.0	50				
ELJFA221□F	220	7	21.0	45				

□ : Symbol of Tolerance *1 : Self Resonant Frequency *2 : DC Resistance

Design and specifications are each subject to change without notice. Ask factory for the current technical specifications before purchase and/or use. Should a safety concern arise regarding this product, please be sure to contact us immediately.

00 Sep. 2010

■ FB Type 4532 (1812)

● Dimensions in mm (not to scale)



● Recommended Land Pattern in mm (not to scale)

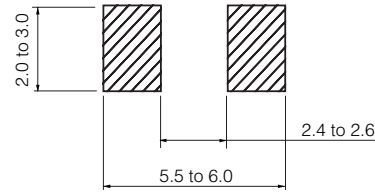

■ Standard Packing Quantity

● 500 pcs./Reel

■ Standard Parts

Part No.	Inductance			Q		SRF *1 (MHz) min.	R _{DC} *2 (Ω) max.	DC Current (mA) max.
	(μH)	Tolerance (%)	Test Freq. (MHz)	min.	Test Freq. (MHz)			
ELJFBR22□F	0.22	M : ±20 %		30	25.2	230	0.30	700
ELJFBR27□F	0.27					200	0.32	650
ELJFBR33□F	0.33					180	0.35	630
ELJFBR39□F	0.39					155	0.37	620
ELJFBR47□F	0.47					135	0.40	580
ELJFBR56□F	0.56					120	0.42	560
ELJFBR68□F	0.68					105	0.48	530
ELJFBR82□F	0.82					90	0.50	500
ELJFB1R0□F	1.0	M:±20 % or K : ±10 %	1.0	50	7.96	80	0.52	470
ELJFB1R2□F	1.2					70	0.55	460
ELJFB1R5□F	1.5					60	0.61	430
ELJFB1R8□F	1.8					50	0.61	410
ELJFB2R2□F	2.2					45	0.61	410
ELJFB2R7□F	2.7					43	0.61	400
ELJFB3R3□F	3.3					39	0.66	380
ELJFB3R9□F	3.9					36	0.74	360
ELJFB4R7□F	4.7					33	0.81	350
ELJFB5R6□F	5.6					30	0.88	330
ELJFB6R8□F	6.8	K : ±10 % or J : ±5 %	0.1	40	5	26	1.0	310
ELJFB8R2□F	8.2					24	1.6	250
ELJFB100□F	10					22	1.8	235
ELJFB120□F	12					20	1.9	225
ELJFB150□F	15					18	2.1	215
ELJFB180□F	18					16	2.3	205
ELJFB220□F	22					15	2.6	195
ELJFB270□F	27					13	2.9	185
ELJFB330□F	33					12	3.1	175
ELJFB390□F	39					10	3.6	165
ELJFB470□F	47	0.796	30	2.52	9.7	4.2	130	
ELJFB560□F	56				9.0	4.7	125	
ELJFB680□F	68				8.2	5.3	115	
ELJFB820□F	82				7.5	5.9	110	
ELJFB101□F	100				6.7	8.8	105	
ELJFB121□F	120				6.1	10	100	
ELJFB151□F	150				5.5	11	95	
ELJFB181□F	180				5.1	13	85	
ELJFB221□F	220				4.5	13	85	
ELJFB271□F	270				4.1	14	80	
ELJFB331□F	330	3.7	16	75				
ELJFB391□F	390	3.3	19	70				
ELJFB471□F	470	3.3	31	55				
ELJFB561□F	560	2.7	35	50				
ELJFB681□F	680	2.5	39	50				
ELJFB821□F	820	2.4	45	45				
ELJFB102□F	1000	2.1	53	40				

□ : Symbol of Tolerance *1 : Self Resonant Frequency *2 : DC Resistance

Design and specifications are each subject to change without notice. Ask factory for the current technical specifications before purchase and/or use. Should a safety concern arise regarding this product, please be sure to contact us immediately.

00 Sep. 2010