

LM2833Z LLP Demo Board

National Semiconductor
Application Note 1845
Alex Gao
February 27, 2009



Introduction

The LM2833Z LLP Demo Board is designed to demonstrate the capabilities of the LM2833Z 3MHz switching regulator in an LLP-10 package.

The demo board is configured to provide an output of 1.2V at up to 3A from an input voltage range of 3V to 5.5V. The board is thermally optimized with the small solution size of 1.2" X 1.1", shown in the demo board schematic in *Figure 1*. The output voltage can be configured to a different value by changing the ratio between R1 and R2 according to the following equation:

$$R1 = R2 \times (VOUT / VFB - 1)$$

The feedback voltage VFB is regulated at 0.60V typically.

The board has C5 reserved for two purposes given different application scenarios. First, at high VOUT applications, the control loop bandwidth is not as large as at low VOUT. Adding C5 at high VOUT can significantly improve the load step response by boosting the loop bandwidth without significantly compromising phase margin. Secondly, it also helps to minimize output voltage overshoot during sluggish startup, short circuit release, and recovery from thermal shutdown, since it creates a feed-forward path between VOUT and VFB, thus speeding up Gm-amplifier recovery. In practice, for a few kΩ of voltage divider bottom resistor R2, a 47nF ceramic capacitor is usually a good choice for C5. Note for applications where VOUT is close to VFB, since R1 is small, the effectiveness of adding C5 becomes decreasingly appreciable. There-

fore, other measures need to be taken to achieve the desired performance. For example, to minimize output overshoot during slow startup at high VOUT, an alternative approach is to apply a separate signal at the EN terminal after VIN is fully established.

Another component which is not populated on the board is C4, which is reserved for applications where a large output capacitor is desired.

Table 1 lists the bill of materials of this demo board. The measured performance characteristics and layout of this board are also included below.

Powering up the Board

Powering up the LM2833Z LLP demo board is a single-step procedure, simply by applying a DC voltage of 3V to 5.5V to VIN and GND terminals. By default, VINC is connected to VIN through a low pass filter to remove any high frequency noise present at the input. EN is connected to VINC through a 100kΩ resistor. A separate logic signal at the EN terminal can be used, if startup and shutdown need to be controlled. A load can be connected between VOUT and GND terminals before or after the board is powered up. At VOUT of 1.2V, the internal soft-start circuit can bring up VOUT smoothly regardless of load or input voltage.

The LM2833Z is designed to skip some pulses at very light loads to maintain output voltage regulation. Depending on load levels, the circuit may operate in either discontinuous or continuous conduction mode.

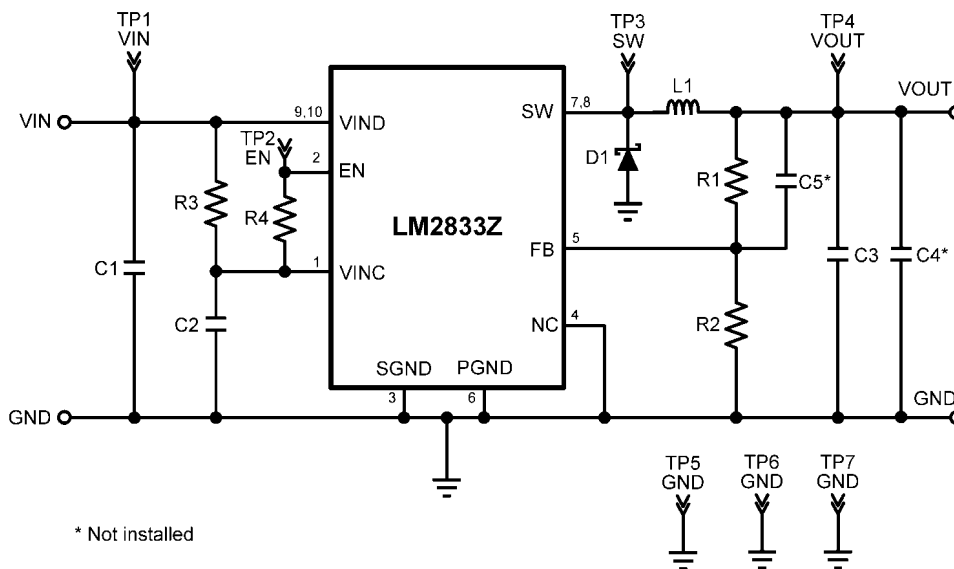
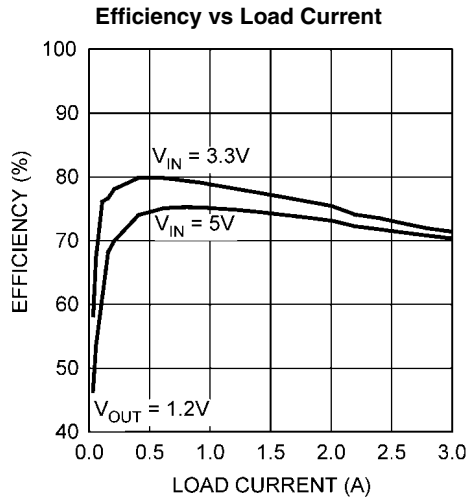

FIGURE 1. LM2833Z LLP Demo Board Schematic

30062301

Typical Performance Characteristics



30062302

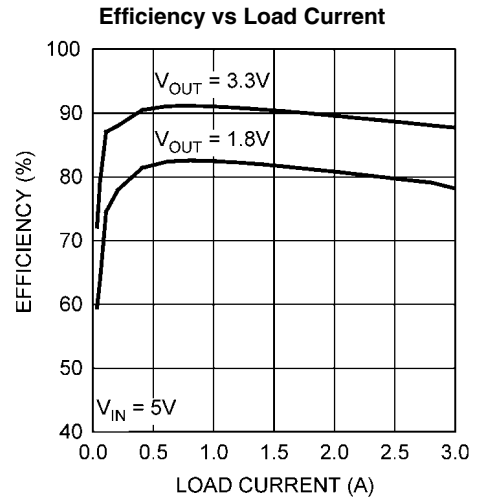

30062303

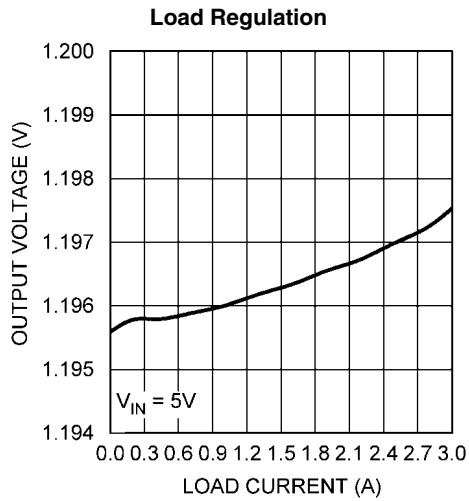

30062304

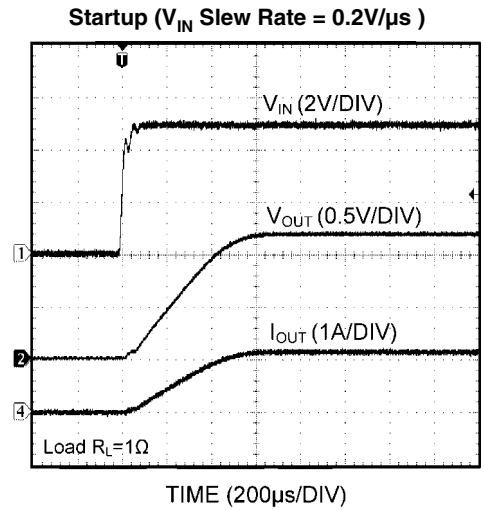

30062305

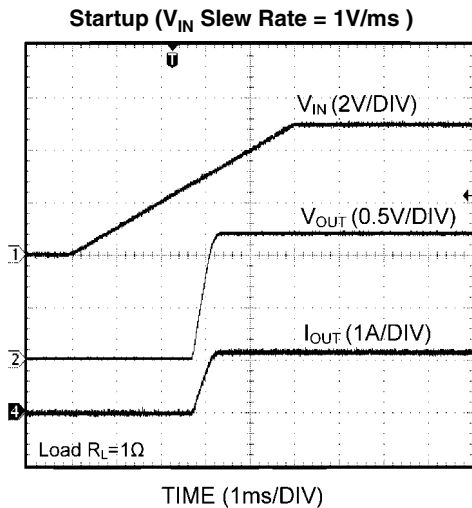

30062306

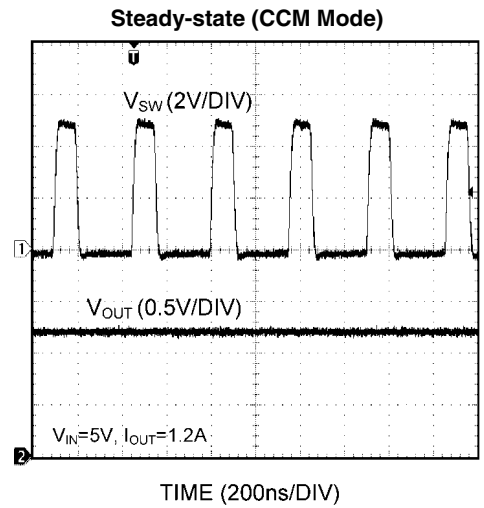

30062307

Steady-state (DCM Mode)

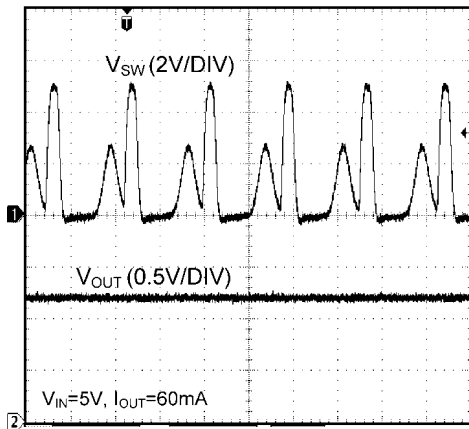

TIME (200ns/DIV)

30062308

Steady-state (Pulse Skipping)

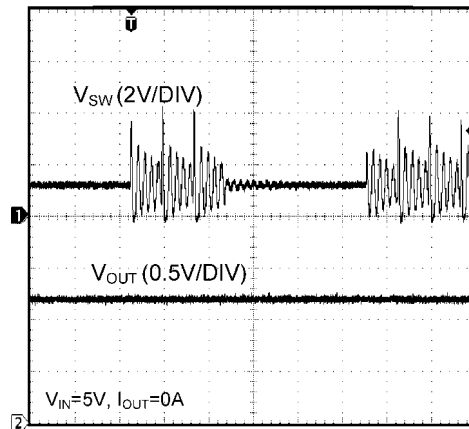

TIME (1μs/DIV)

30062309

**Load Transient (Slew Rate = 0.1A/μs)
(C5 not installed)**

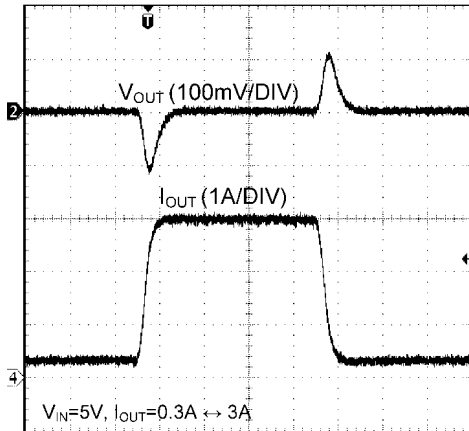

TIME (100μs/DIV)

30062314

**Load Transient (Slew Rate = 0.1A/μs)
(C5 = 47nF)**

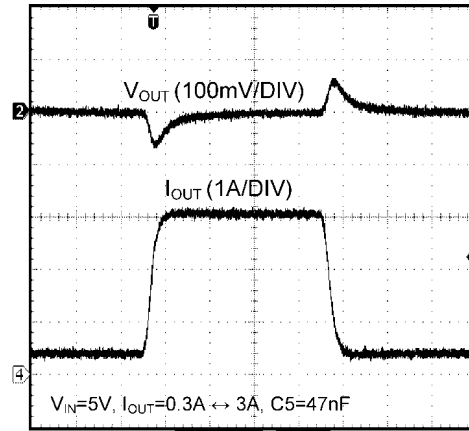

TIME (100μs/DIV)

30062315

Line Transient

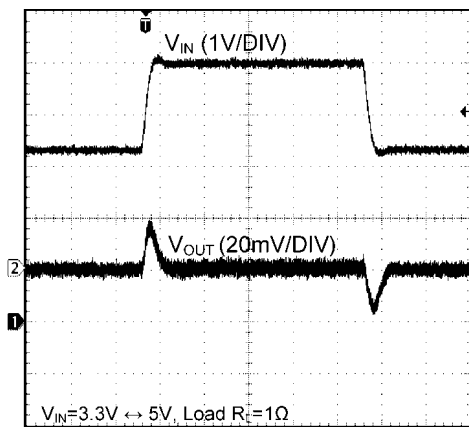

TIME (100μs/DIV)

30062316

Loop Gain

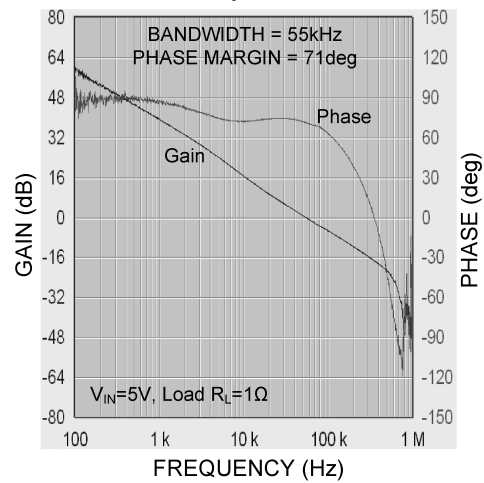

30062317

Layout

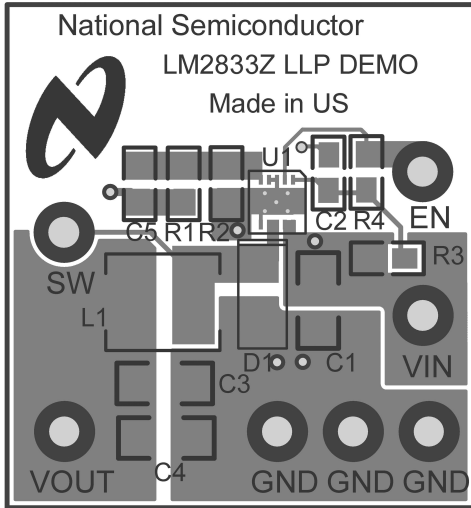

Top Layer and Top Overlay

30062310

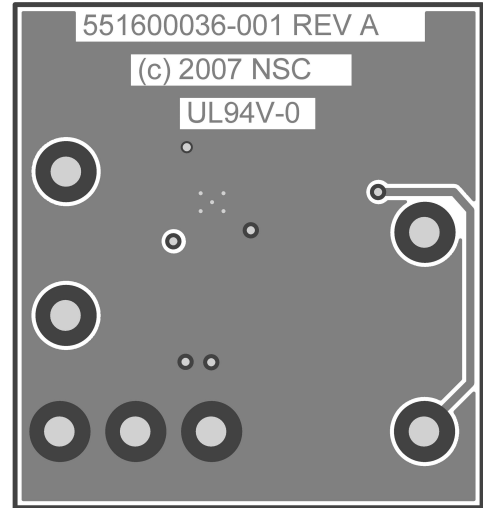

Bottom Layer

30062311

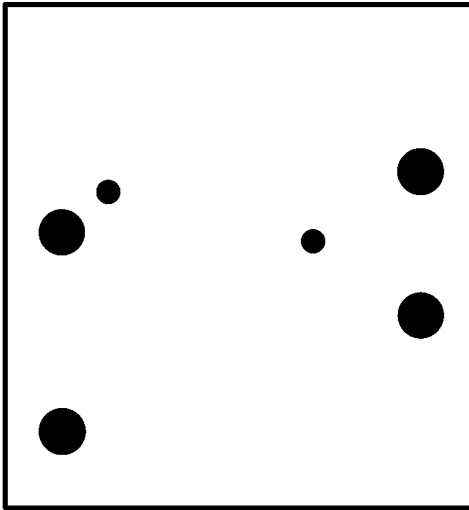

Internal Plane 1 (GND)

30062312

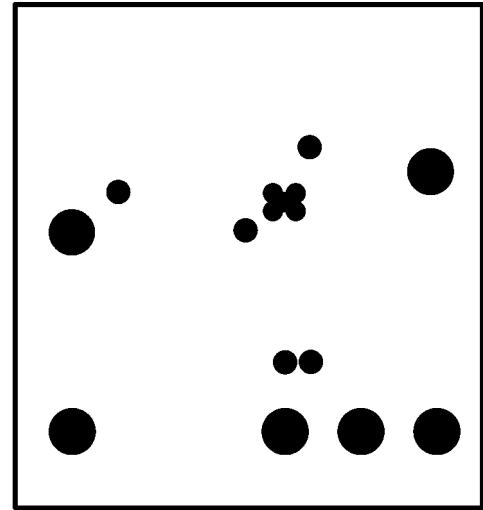

Internal Plane 2 (VIN)

30062313

Bill of Materials

TABLE 1. Bill of Materials

Part ID	Part Value	Part Number	Manufacturer
U1	3MHz 3.0A buck regulator, LLP-10	LM2833ZSD	National Semiconductor
L1	1.0 μ H, 4A, 5x5x2mm ³	NP04SZB1R0N	Taiyo Yuden
C1	22 μ F, 6.3V, X5R, 1206	C3216X5R0J226MT	TDK
C2	0.22 μ F, 10V, X7R, 0805	GRM216R71A224KC01D	Murata
C3	47 μ F, 6.3V, X5R, 1206	JMK316BJ476ML-T	Taiyo Yuden
C4	Open		
C5	Open		
D1	Schottky, 30V, 3A, 3-4E1A	CMS01	Toshiba
R1	2.00k Ω , 1%, 1/8W, 0805	CRCW08052K00FKEA	Vishay
R2	2.00k Ω , 1%, 1/8W, 0805	CRCW08052K00FKEA	Vishay
R3	10.0 Ω , 1%, 1/8W, 0805	CRCW080510R0FKEA	Vishay
R4	100k Ω , 1%, 1/8W, 0805	CRCW0805100KFKEA	Vishay

Notes

AN-1845

Notes

For more National Semiconductor product information and proven design tools, visit the following Web sites at:

Products		Design Support	
Amplifiers	www.national.com/amplifiers	WEBENCH® Tools	www.national.com/webench
Audio	www.national.com/audio	App Notes	www.national.com/appnotes
Clock and Timing	www.national.com/timing	Reference Designs	www.national.com/refdesigns
Data Converters	www.national.com/adc	Samples	www.national.com/samples
Interface	www.national.com/interface	Eval Boards	www.national.com/evalboards
LVDS	www.national.com/lvds	Packaging	www.national.com/packaging
Power Management	www.national.com/power	Green Compliance	www.national.com/quality/green
Switching Regulators	www.national.com/switchers	Distributors	www.national.com/contacts
LDOs	www.national.com/ldo	Quality and Reliability	www.national.com/quality
LED Lighting	www.national.com/led	Feedback/Support	www.national.com/feedback
Voltage Reference	www.national.com/vref	Design Made Easy	www.national.com/easy
PowerWise® Solutions	www.national.com/powerwise	Solutions	www.national.com/solutions
Serial Digital Interface (SDI)	www.national.com/sdi	Mil/Aero	www.national.com/milaero
Temperature Sensors	www.national.com/tempsensors	SolarMagic™	www.national.com/solarmagic
Wireless (PLL/VCO)	www.national.com/wireless	Analog University®	www.national.com/AU

THE CONTENTS OF THIS DOCUMENT ARE PROVIDED IN CONNECTION WITH NATIONAL SEMICONDUCTOR CORPORATION ("NATIONAL") PRODUCTS. NATIONAL MAKES NO REPRESENTATIONS OR WARRANTIES WITH RESPECT TO THE ACCURACY OR COMPLETENESS OF THE CONTENTS OF THIS PUBLICATION AND RESERVES THE RIGHT TO MAKE CHANGES TO SPECIFICATIONS AND PRODUCT DESCRIPTIONS AT ANY TIME WITHOUT NOTICE. NO LICENSE, WHETHER EXPRESS, IMPLIED, ARISING BY ESTOPPEL OR OTHERWISE, TO ANY INTELLECTUAL PROPERTY RIGHTS IS GRANTED BY THIS DOCUMENT.

TESTING AND OTHER QUALITY CONTROLS ARE USED TO THE EXTENT NATIONAL DEEMS NECESSARY TO SUPPORT NATIONAL'S PRODUCT WARRANTY. EXCEPT WHERE MANDATED BY GOVERNMENT REQUIREMENTS, TESTING OF ALL PARAMETERS OF EACH PRODUCT IS NOT NECESSARILY PERFORMED. NATIONAL ASSUMES NO LIABILITY FOR APPLICATIONS ASSISTANCE OR BUYER PRODUCT DESIGN. BUYERS ARE RESPONSIBLE FOR THEIR PRODUCTS AND APPLICATIONS USING NATIONAL COMPONENTS. PRIOR TO USING OR DISTRIBUTING ANY PRODUCTS THAT INCLUDE NATIONAL COMPONENTS, BUYERS SHOULD PROVIDE ADEQUATE DESIGN, TESTING AND OPERATING SAFEGUARDS.

EXCEPT AS PROVIDED IN NATIONAL'S TERMS AND CONDITIONS OF SALE FOR SUCH PRODUCTS, NATIONAL ASSUMES NO LIABILITY WHATSOEVER, AND NATIONAL DISCLAIMS ANY EXPRESS OR IMPLIED WARRANTY RELATING TO THE SALE AND/OR USE OF NATIONAL PRODUCTS INCLUDING LIABILITY OR WARRANTIES RELATING TO FITNESS FOR A PARTICULAR PURPOSE, MERCHANTABILITY, OR INFRINGEMENT OF ANY PATENT, COPYRIGHT OR OTHER INTELLECTUAL PROPERTY RIGHT.

LIFE SUPPORT POLICY

NATIONAL'S PRODUCTS ARE NOT AUTHORIZED FOR USE AS CRITICAL COMPONENTS IN LIFE SUPPORT DEVICES OR SYSTEMS WITHOUT THE EXPRESS PRIOR WRITTEN APPROVAL OF THE CHIEF EXECUTIVE OFFICER AND GENERAL COUNSEL OF NATIONAL SEMICONDUCTOR CORPORATION. As used herein:

Life support devices or systems are devices which (a) are intended for surgical implant into the body, or (b) support or sustain life and whose failure to perform when properly used in accordance with instructions for use provided in the labeling can be reasonably expected to result in a significant injury to the user. A critical component is any component in a life support device or system whose failure to perform can be reasonably expected to cause the failure of the life support device or system or to affect its safety or effectiveness.

National Semiconductor and the National Semiconductor logo are registered trademarks of National Semiconductor Corporation. All other brand or product names may be trademarks or registered trademarks of their respective holders.

Copyright© 2009 National Semiconductor Corporation

For the most current product information visit us at www.national.com



National Semiconductor Americas Technical Support Center
Email: support@nsc.com
Tel: 1-800-272-9959

National Semiconductor Europe Technical Support Center
Email: europe.support@nsc.com

National Semiconductor Asia Pacific Technical Support Center
Email: ap.support@nsc.com

National Semiconductor Japan Technical Support Center
Email: jpn.feedback@nsc.com