

SERIES 47B
Sealed Miniature Rocker and Paddle Switches

FEATURES

- Save Space and Weight
- SPDT, DPDT and 3PDT Circuitry
- Choice of Actuators and Terminations
- Sealed per IP-67

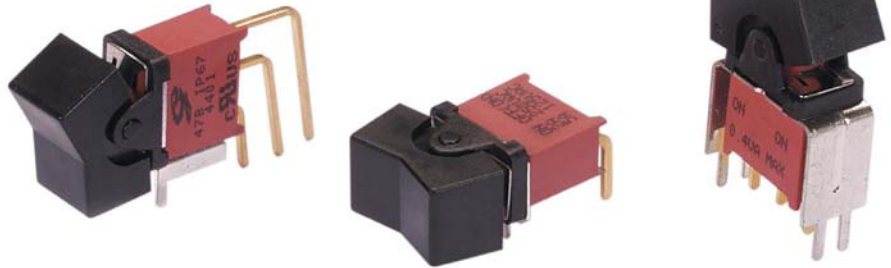

MODELS In inches (and millimeters)

MODEL NO.	SWITCH POSITION		
WSP1	ON	NONE	ON
WSP2	ON	NONE	(ON)
WSP3	ON	OFF	ON
WSP4	(ON)	OFF	(ON)
WSP5	ON	OFF	(ON)
TERM. COMM.	2-3	OPEN	2-1

()=MOMENTARY

02COMM.

SCHEMATIC



SPDT

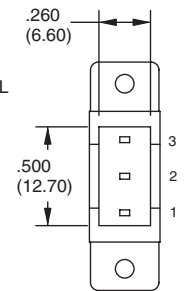
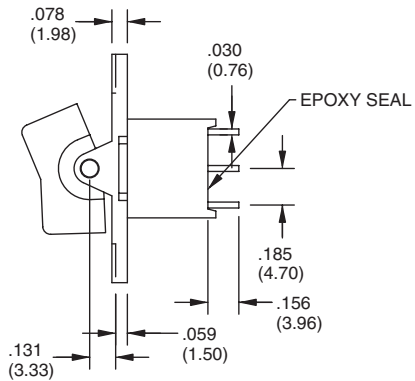
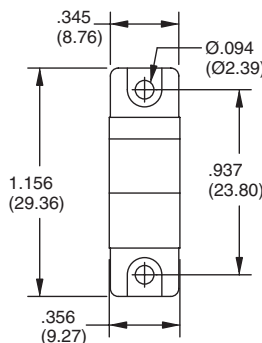

MODEL NO.	SWITCH POSITION		
WDP1	ON	NONE	ON
WDP2	ON	NONE	(ON)
WDP3	ON	OFF	ON
WDP4	(ON)	OFF	(ON)
WDP5	ON	OFF	(ON)
TERM. COMM.	2-3,5-6	OPEN	2-1,5-4

()=MOMENTARY

02COMM. 05COMM.

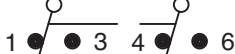

SCHEMATIC

DPDT

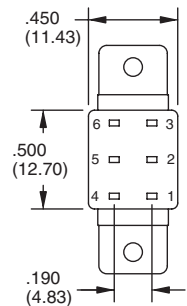
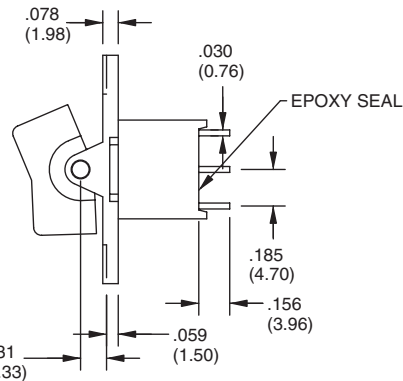
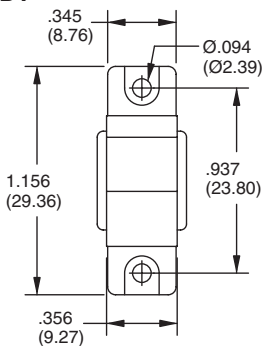

MODEL NO.	SWITCH POSITION		
W3P1	ON	NONE	ON
W3P2	ON	NONE	(ON)
W3P3	ON	OFF	ON
W3P4	(ON)	OFF	(ON)
W3P5	ON	OFF	(ON)
TERM. COMM.	2-3,5-6	OPEN	2-1,5-4

()=MOMENTARY

02COMM. 05COMM. 08COMM.



SCHEMATIC

3PDT

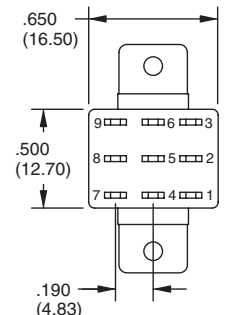
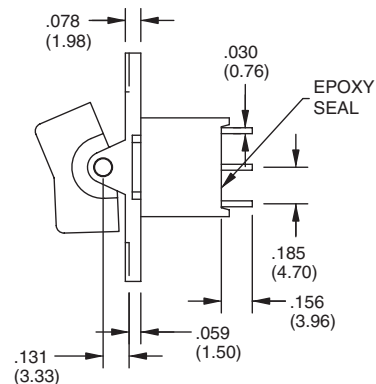
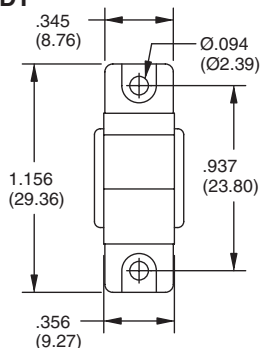

Rocker and Paddle Switches

ACTUATOR OPTIONS In inches (and millimeters)

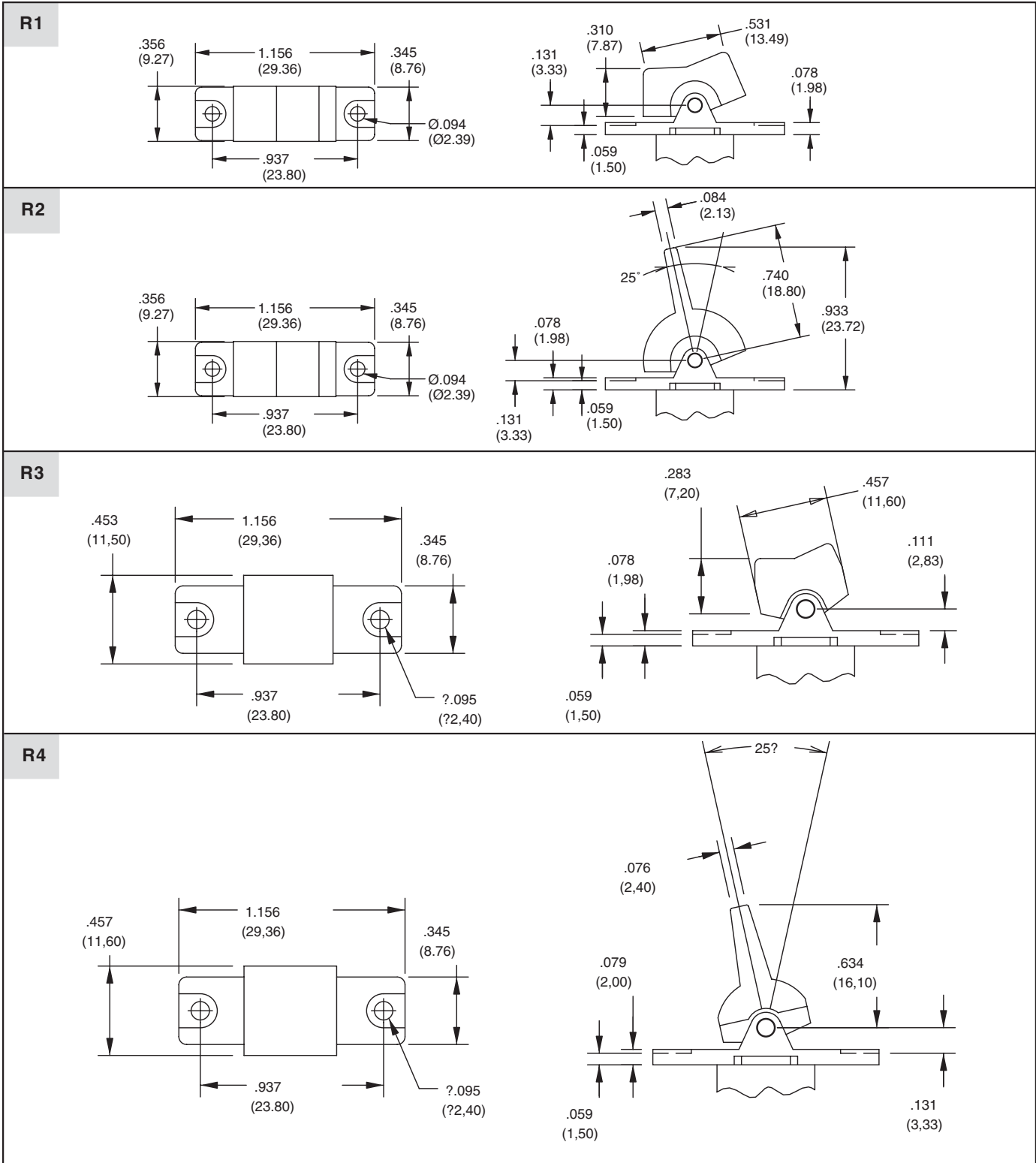

Rocker and Paddle Switches

ACTUATOR OPTIONS In inches (and millimeters)

<p>J1</p>		
<p>J2</p>		
<p>J3</p>		
<p>J4</p>		
<p>J5</p>		

Rocker and Paddle Switches

TERMINATION OPTIONS In inches (and millimeters)

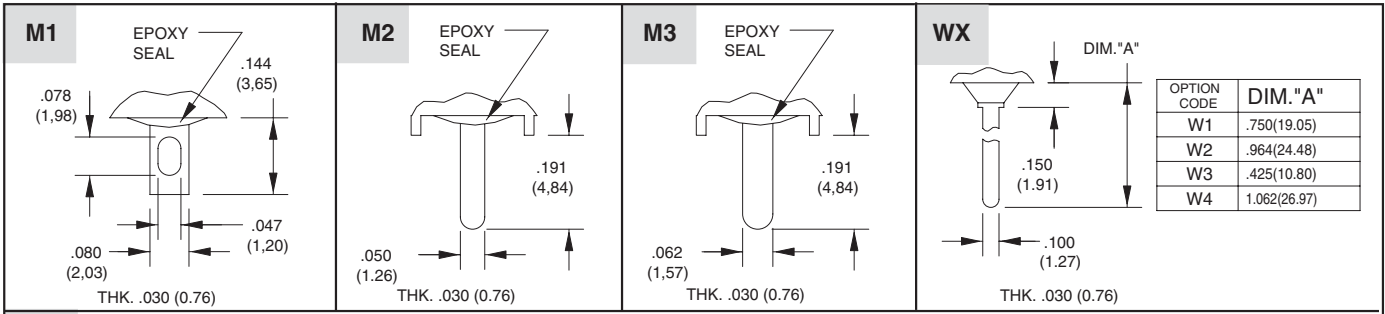

M6 Right Angle P.C. Mount, Horizontal Actuation

SPDT

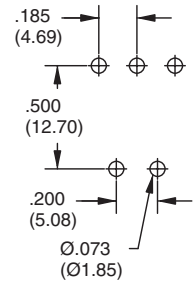
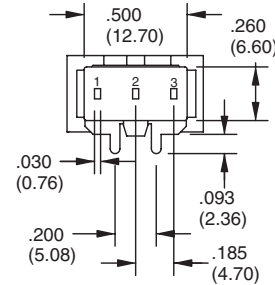
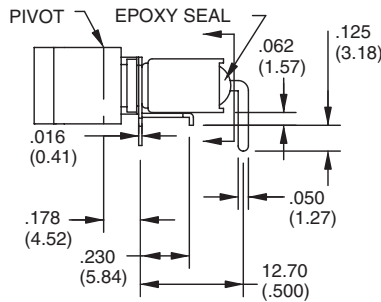
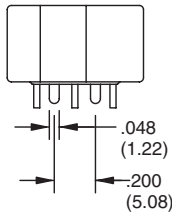

DPDT

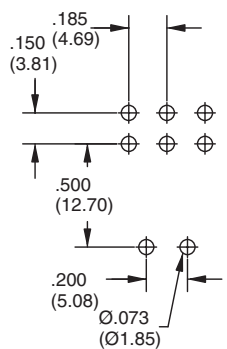
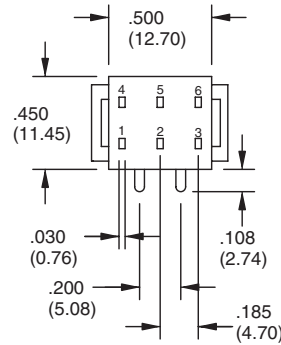
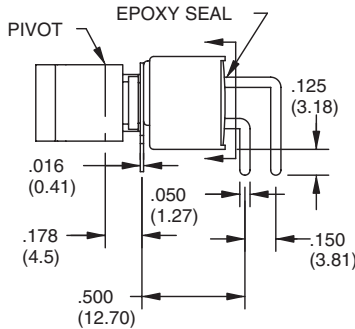
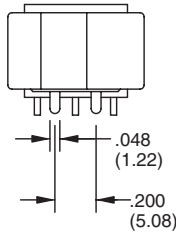

3PDT

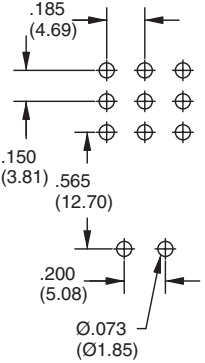
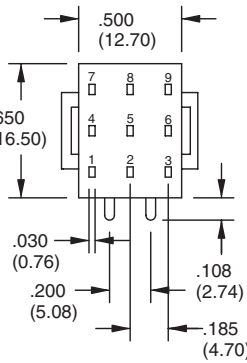
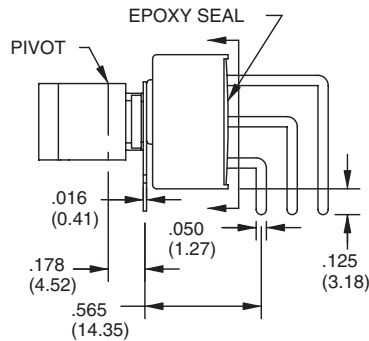
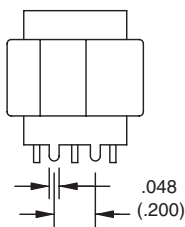

M7 Right Angle P.C. Mount, Vertical Actuation

SPDT

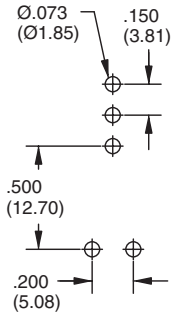
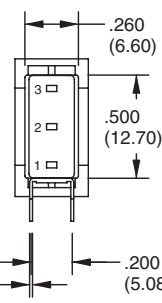
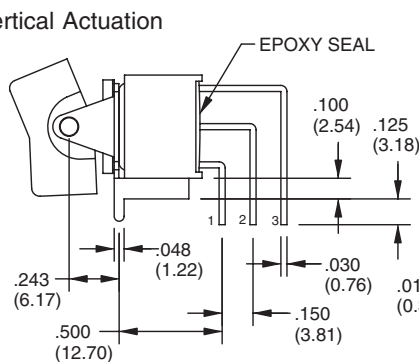
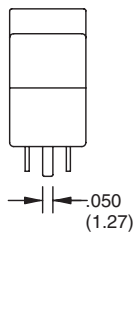

TERMINATION OPTIONS In inches (and millimeters)

DPDT

3PDT

V2-V3 Vertical Bracket P.C. Mount

SPDT

OPTION CODE	DIM."A"
V2	.460 (11.68)
V3	.630 (16.00)

DPDT

OPTION CODE	DIM."A"
V2	.460 (11.68)
V3	.630 (16.00)

3PDT

OPTION CODE	DIM."A"
V2	.460 (11.68)
V3	.630 (16.00)

Rocker and Paddle Switches

Grayhill, Inc. • 561 Hillgrove Avenue • LaGrange, Illinois 60525-5997 • USA • Phone: 708-354-1040 • Fax: 708-354-2820 • www.grayhill.com

Rocker 13

Downloaded from Elcodis.com electronic components distributor

SPECIFICATIONS

RATINGS

Contact Rating: Q option - 5A with resistive load @ 125 VAC or 28 VDC; 2A with resistive load @ 250 VAC. R option - 0.4 VA max @ 20 Vmax (AC or DC)

Electrical Life: 50,000 make-and-break cycles at full load

Contact Resistance: Below 10 milliohms max. initial @ 2-4 VDC, 100 mA

Insulation Resistance: 1,000 megaohms minimum

Dielectric Strength: 1,500 V RMS @ sea level

Operating Temperature: -30°C to 85°C

MATERIALS

Case and Bushing: Glass-filled nylon 6/6 , flame retardant, heat stabilized (UL94V-0)

Actuator: Nylon, black standard. Internal O-ring seal standard with all actuators.

Frame: Spring steel, black (standard)

Switch Support: Brass, tin-plated

Actuator Pivot & Mounting Bracket:

Nylon (UL 94V-0)

Actuator Pivot Retainer: Stainless Steel

Terminal Seal: Epoxy

Terminal/Contacts: Copper alloy with gold plate over nickel or silver plate

ORDERING INFORMATION

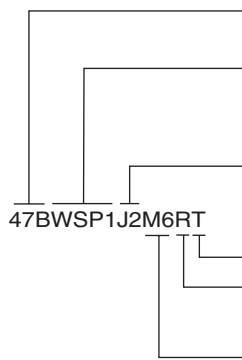

Series Sealed Miniature Rocker and Paddle Switches

Model: SPDT: WSP1, WSP2, WSP3, WSP4, WSP5
 DPDT: WDP1, WDP2, WDP3, WDP4, WDP5
 3PDT: W3P1, W3P2, W3P3, W3P4, W3P5
 (See Model options.)

Actuator: R1, R2, R3, R4, J1, J2, J3, J4, J5
 (See Actuator options)

RoHS Compliant

Contact: R = Copper alloy, gold plate over nickel plate,
 Q = Copper alloy, gold plate over silver plate

Termination Options: M1, M2, M6, M7, V2, V3, W1, W2, W3, W4
 (See Termination options)

Available from your local Grayhill Component Distributor. For prices and discounts, contact a local Sales Office, an authorized local Distributor or Grayhill.