



PD55015-E PD55015S-E

RF POWER transistor, LdmoST plastic family N-channel enhancement-mode, lateral MOSFETs

Features

- Excellent thermal stability
- Common source configuration
- $P_{OUT}=15\text{ W}$ with 14dB gain @ 500 MHz/12.5 V
- New RF plastic package

Description

The device is a common source N-channel, enhancement-mode lateral field-effect RF power transistor. It is designed for high gain, broad band commercial and industrial applications. It operates at 12 V in common source mode at frequencies of up to 1 GHz. The device boasts the excellent gain, linearity and reliability of ST's latest LDMOS technology mounted in the first true SMD plastic RF power package, PowerSO-10RF. Device's superior linearity performance makes it an ideal solution for car mobile radio. The PowerSO-10 plastic package, designed to offer high reliability, is the first ST JEDEC approved, high power SMD package. It has been specially optimized for RF needs and offers excellent RF performance and ease of assembly. Mounting recommendations are available in www.st.com/rf/ (look for application note AN1294).

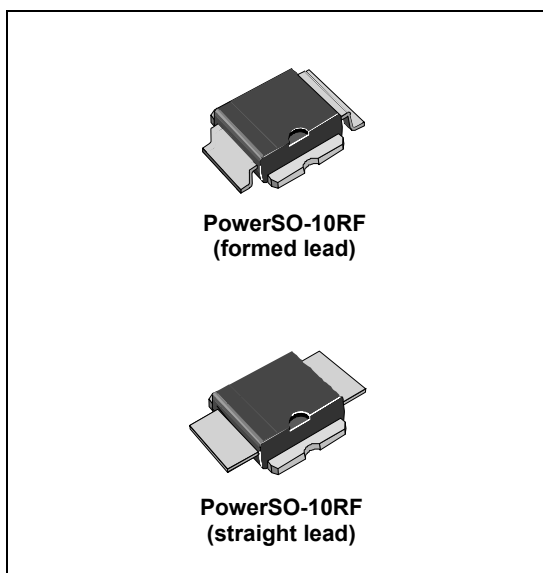

Figure 1. Pin connection

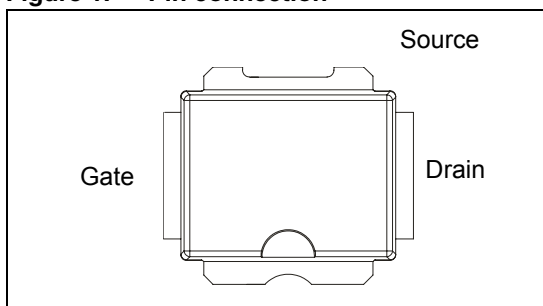

Table 1. Device summary

Order code	Package	Packing
PD55015-E	PowerSO-10RF (formed lead)	Tube
PD55015S-E	PowerSO-10RF (straight lead)	Tube
PD55015TR-E	PowerSO-10RF (formed lead)	Tape and reel
PD55015STR-E	PowerSO-10RF (straight lead)	Tape and reel

Contents

1	Electrical data	3
1.1	Maximum ratings	3
1.2	Thermal data	3
2	Electrical characteristics	4
2.1	Static	4
2.2	Dynamic	4
2.3	Moisture sensitivity level	4
3	Impedance	5
4	Typical performance	6
4.1	PD55015-E	7
4.2	PD55015S-E	9
5	Test circuit	11
6	Circuit layout	12
7	Common source s-parameter	13
8	Package mechanical data	19
9	Revision history	24

1 Electrical data

1.1 Maximum ratings

Table 2. Absolute maximum ratings ($T_{CASE} = 25^{\circ}C$)

Symbol	Parameter	Value	Unit
$V_{(BR)DSS}$	Drain-source voltage	40	V
V_{GS}	Gate-source voltage	± 20	V
I_D	Drain current	5	A
P_{DISS}	Power dissipation (@ $T_C = 70^{\circ}C$)	73	W
T_J	Max. operating junction temperature	165	$^{\circ}C$
T_{STG}	Storage temperature	-65 to +150	$^{\circ}C$

1.2 Thermal data

Table 3. Thermal data

Symbol	Parameter	Value	Unit
R_{thJC}	Junction - case thermal resistance	1.2	$^{\circ}C/W$

2 Electrical characteristics

$T_{CASE} = +25\text{ }^{\circ}\text{C}$

2.1 Static

Table 4. Static

Symbol	Test conditions		Min	Typ	Max	Unit
I_{DSS}	$V_{GS} = 0$	$V_{DS} = 28\text{ V}$			1	μA
I_{GSS}	$V_{GS} = 20\text{ V}$	$V_{DS} = 0$			1	μA
$V_{GS(Q)}$	$V_{DS} = 10\text{ V}$	$I_D = 150\text{ mA}$	2.0		5.0	V
$V_{DS(ON)}$	$V_{GS} = 10\text{ V}$	$I_D = 2.5\text{ A}$			0.8	V
g_{FS}	$V_{DS} = 10\text{ V}$	$I_D = 2.5\text{ A}$	2.0	2.5		mho
C_{ISS}	$V_{GS} = 0$	$V_{DS} = 12.5\text{ V}$		89		pF
C_{OSS}	$V_{GS} = 0$	$V_{DS} = 12.5\text{ V}$		60		pF
C_{RSS}	$V_{GS} = 0$	$V_{DS} = 12.5\text{ V}$		6.5		pF

2.2 Dynamic

Table 5. Dynamic

Symbol	Test conditions		Min	Typ	Max	Unit
P_{1dB}	$V_{DD} = 12.5\text{ V}$, $I_{DQ} = 150\text{ mA}$	$f = 500\text{ MHz}$	15			W
G_P	$V_{DD} = 12.5\text{ V}$, $I_{DQ} = 150\text{ mA}$, $P_{OUT} = 15\text{ W}$, $f = 500\text{ MHz}$		12	14		dB
η_D	$V_{DD} = 12.5\text{ V}$, $I_{DQ} = 150\text{ mA}$, $P_{OUT} = 15\text{ W}$, $f = 500\text{ MHz}$		50	55		%
Load mismatch	$V_{DD} = 15.5\text{ V}$, $I_{DQ} = 150\text{ mA}$, $P_{OUT} = 15\text{ W}$, $f = 500\text{ MHz}$ All phase angles		20:1			VSWR

2.3 Moisture sensitivity level

Table 6. Moisture sensitivity level

Test methodology	Rating
J-STD-020B	MSL 3

3 Impedance

Figure 2. Current conventions

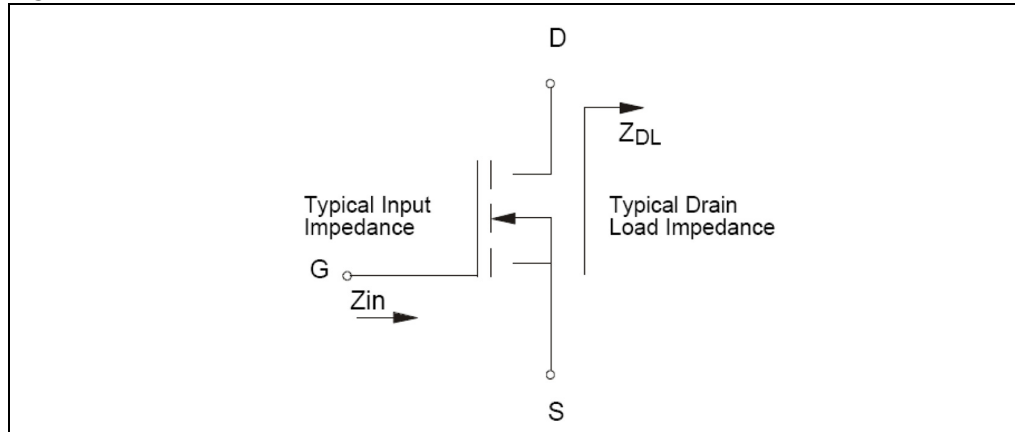

Table 7. Impedance data

PD55015			PD55015S		
Freq. (MHz)	Z _{IN} (Ω)	Z _{DL} (Ω)	Freq. (MHz)	Z _{IN} (Ω)	Z _{DL} (Ω)
480	1.58 + j 0.56	1.27 - j 1.36	480	1.30 - j 0.54	1.18 + j 0.04
500	1.53 + j 0.77	1.51 - j 1.81	500	1.26 - j 0.30	1.32 - j 0.22
520	1.70 + j 1.17	1.44 - j 2.13	520	1.34 - j 0.11	1.46 - j 0.22
			876	0.33 + j 0.44	1.36 - j 0.21
			900	0.33 + j 0.70	1.29 - j 1.03
			915	0.33 + j 0.87	1.27 - j 0.37

4 Typical performance

Figure 3. Capacitance vs. drain voltage

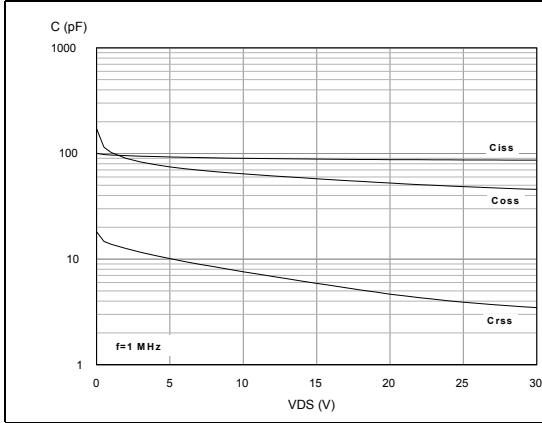

Figure 4. Drain current vs. gate voltage

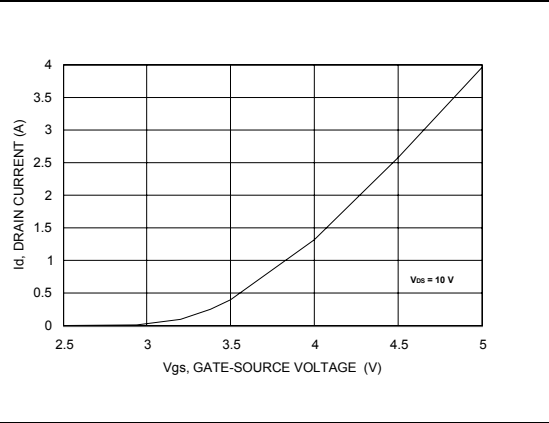
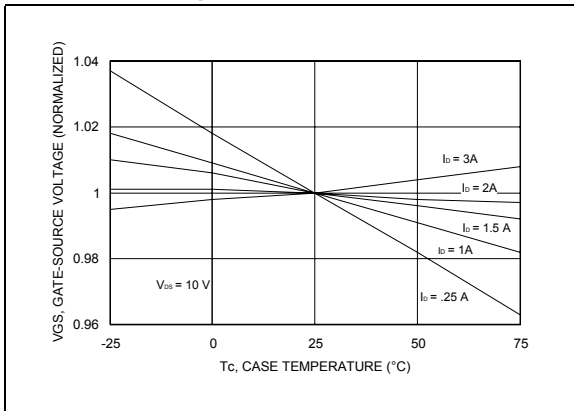

Figure 5. Gate-source voltage vs. case temperature



4.1 PD55015-E

Figure 6. Output power vs. input power

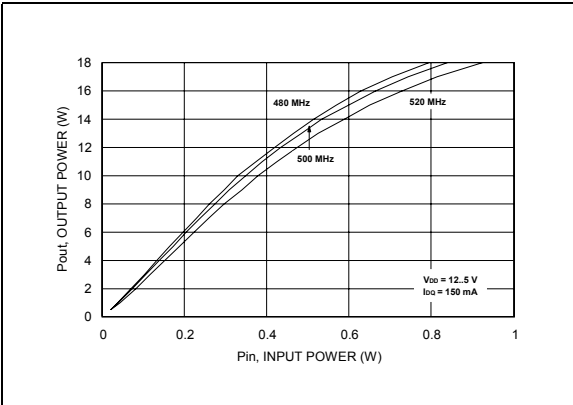

Figure 7. Power gain vs. output power

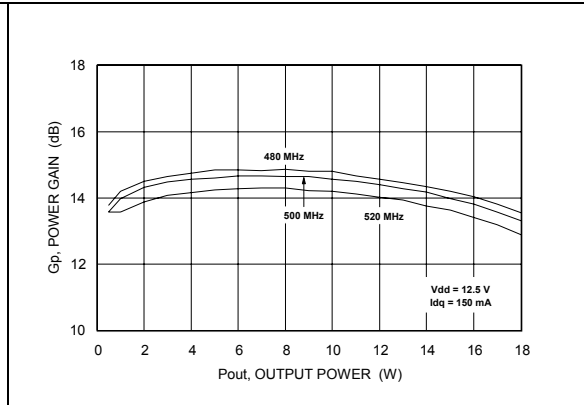

Figure 8. Drain efficiency vs. output power

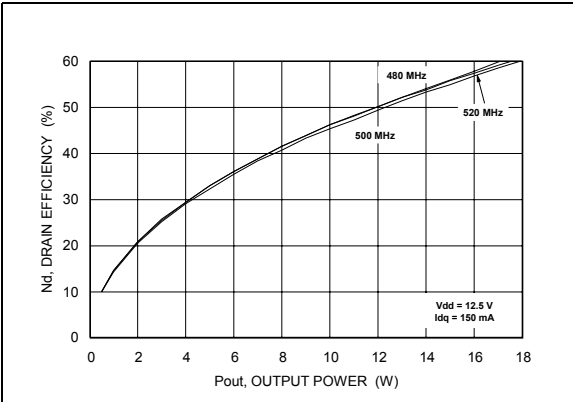

Figure 9. Return loss vs. output power

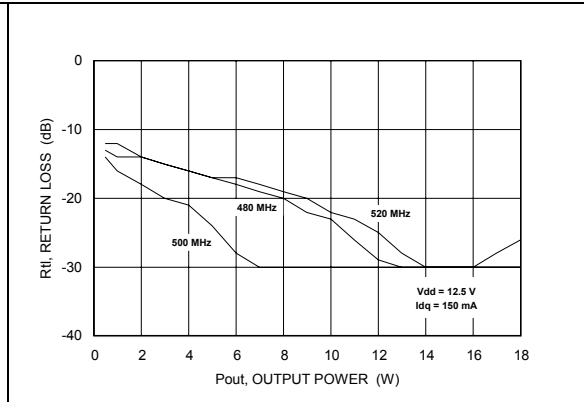

Figure 10. Output power vs. bias current

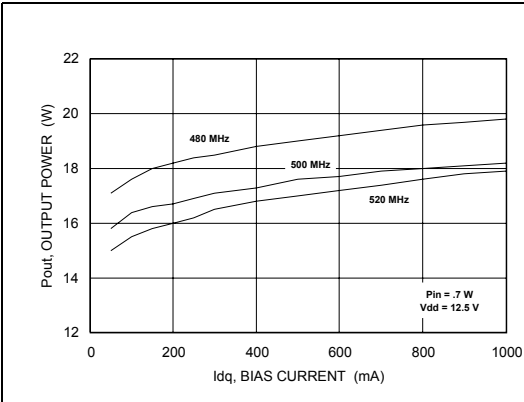

Figure 11. Drain efficiency vs. bias current

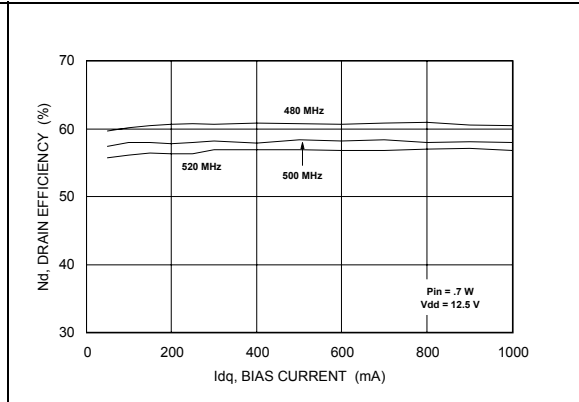

Figure 12. Output power vs. drain voltage

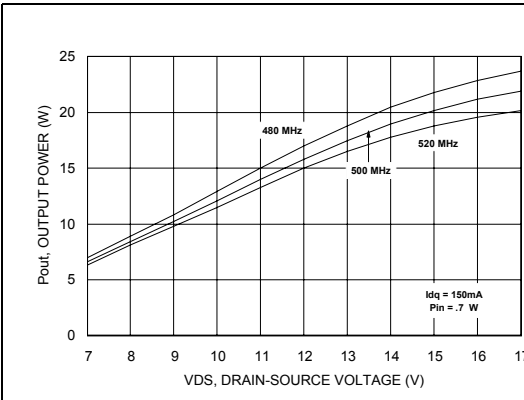

Figure 13. Drain efficiency vs. drain voltage

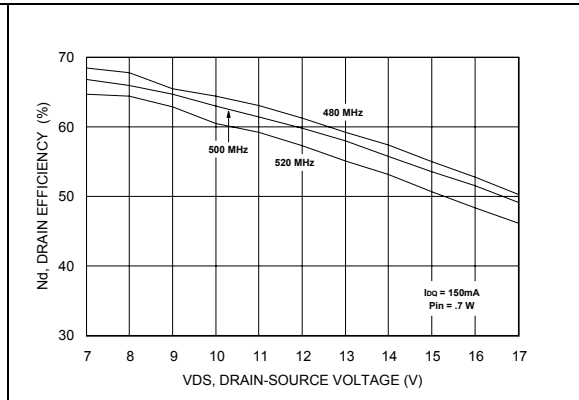
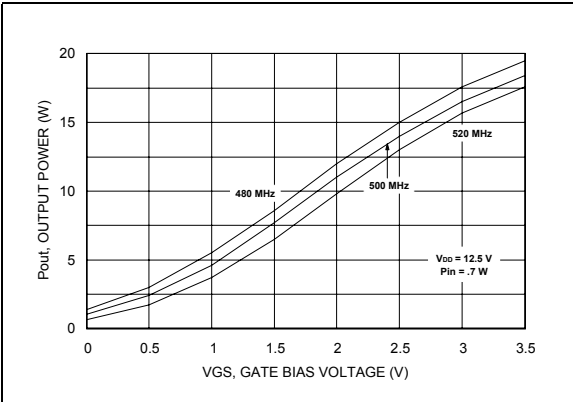

Figure 14. Output power vs. gate bias voltage



4.2 PD55015S-E

Figure 15. Output power vs. input power

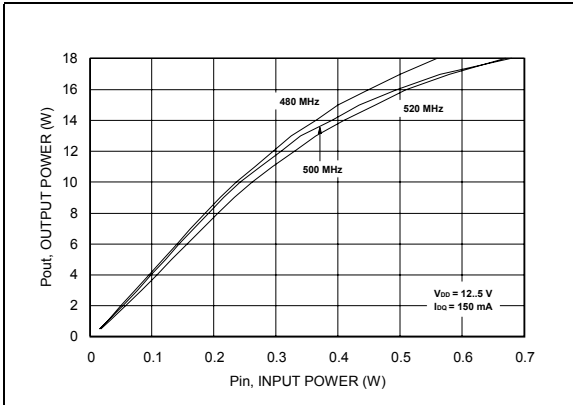

Figure 16. Power gain vs. output power

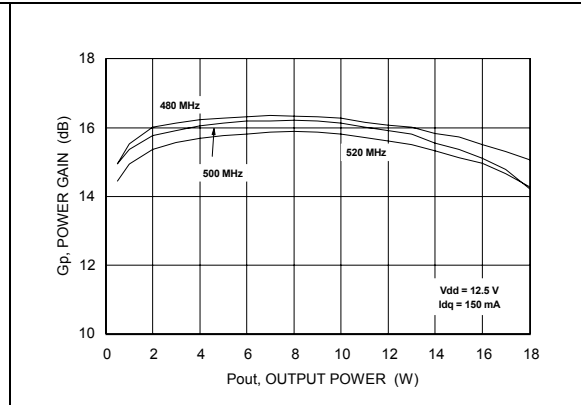

Figure 17. Drain efficiency vs. output power

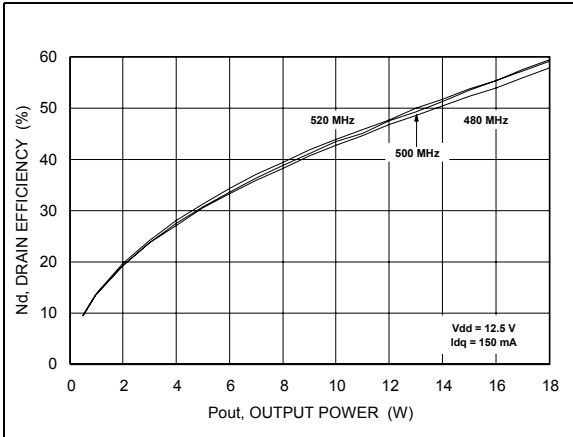

Figure 18. Return loss vs. output power

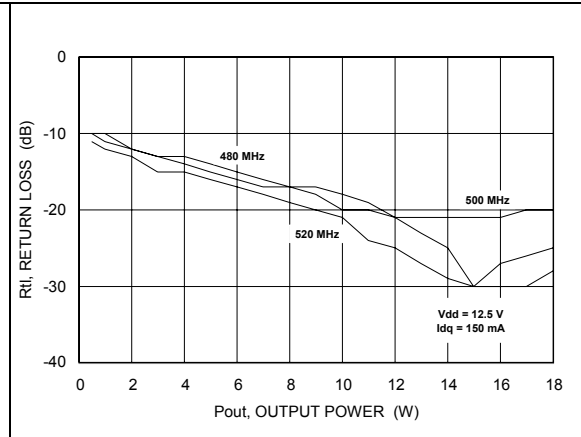

Figure 19. Output power vs. gate bias current

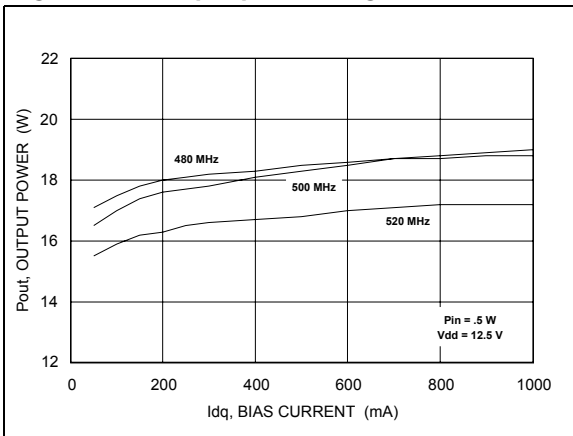

Figure 20. Drain efficiency vs. bias current

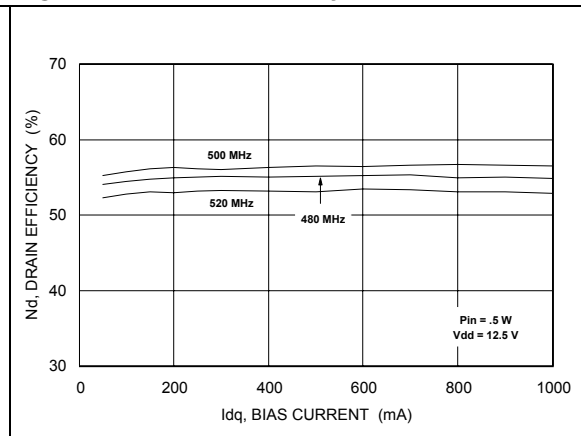

Figure 21. Output power vs. drain voltage

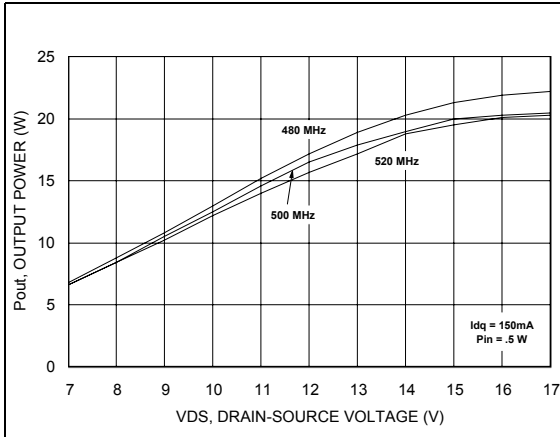

Figure 22. Drain efficiency vs. drain voltage

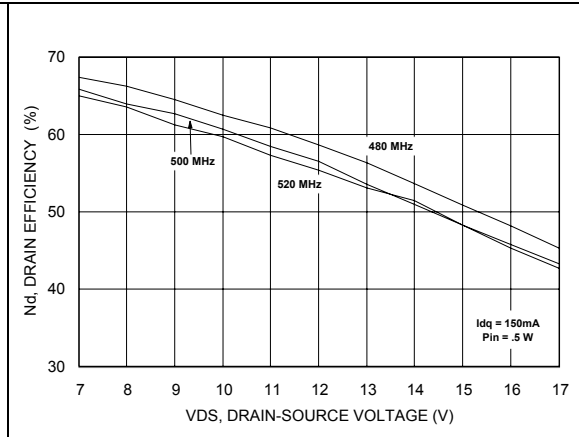

Figure 23. Output power vs. gate bias voltage

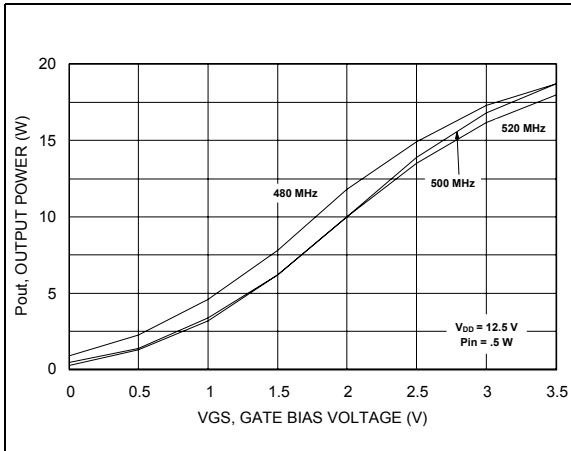

Figure 24. Power gain vs. output power

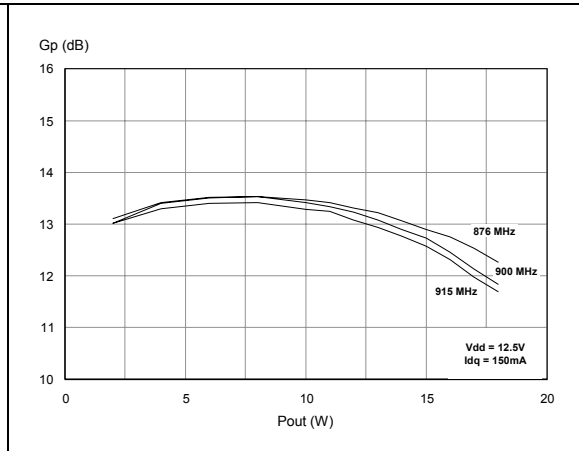

Figure 25. Drain efficiency vs. output power

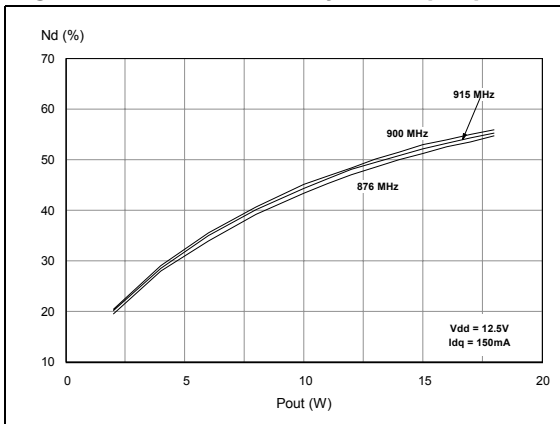
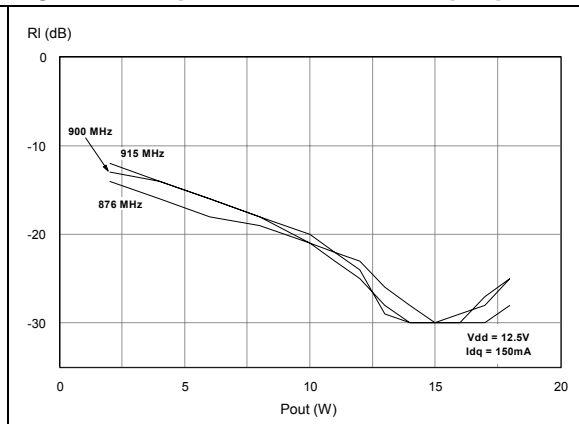

Figure 26. Input return Loss vs. output power



5 Test circuit

Figure 27. Test circuit schematic

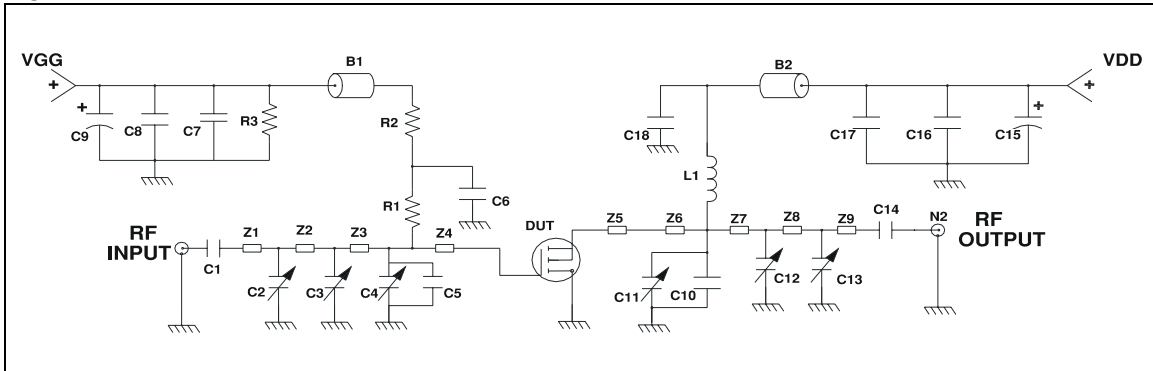

Table 8. Test circuit component part list

Component	Description
B1,B2	Ferrite bead - Fair-rite Corp #2743021447
C1,C12	300 pF, 100 mil chip capacitor
C2,C3,C4,C11,C12,C13	1 to 20 pF trimmer capacitor
C6, C18	120 pF 100 mil chip capacitor
C9, C15	10 μ F, 50 V electrolytic capacitor
C8, C16	0.1 mF, 100 mil chip cap
C7, C17	1.000 pF 100 mil chip cap
C5, C10	33 pF, 100 mil chip cap
L1	56 nH, 6 turns, 18 AWG magnet wire, $l_d = .140$ " hand wound choke
N1, N2	Type N flange mount
R1	15 Ω , 1 W chip resistor
R2	1 k Ω , 1 W chip resistor
R3	33 k Ω , 1 W chip resistor
Z1	0.471" X 0.080" microstrip
Z2	1.082" X 0.080" microstrip
Z3	0.372" X 0.080" microstrip
Z4,Z5	0.260" X 0.223" microstrip
Z6	0.050" X 0.080" microstrip
Z7	0.551" X 0.080" microstrip
Z8	0.825" X 0.080" microstrip
Z9	0.489" X 0.080" microstrip
Board	Roger, ultra lam 2000 THK 0.030", $\epsilon_r = 2.55$ 2oz. ED cu 2 sides.

6 Circuit layout

Figure 28. Test fixture component layout

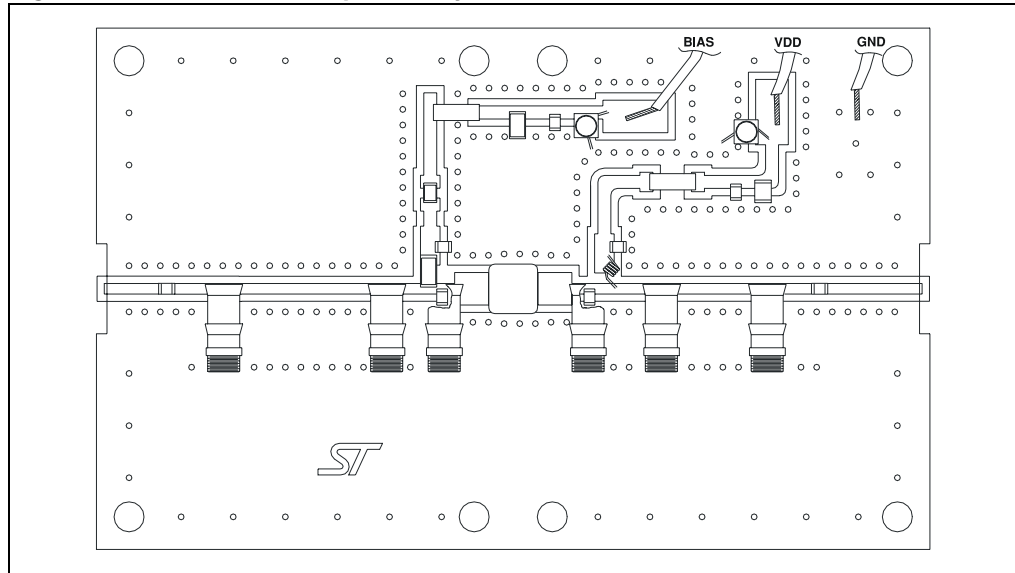
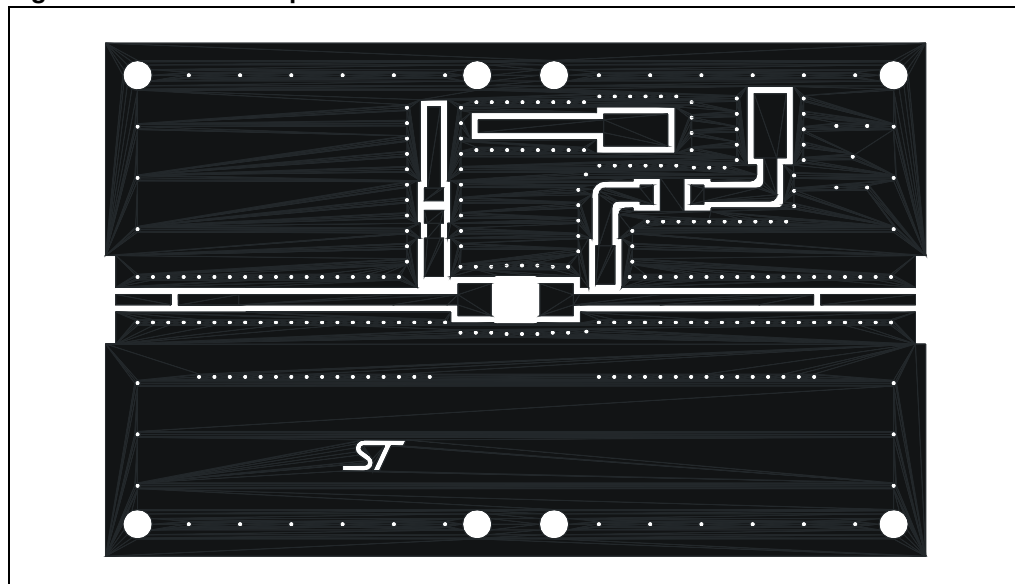

Figure 29. Test circuit photomaster



7 Common source s-parameter

Table 9. S-parameter for PD55015-E ($V_{DS} = 12.5\text{ V}$ $I_{DS} = 225\text{ mA}$)

Freq (MHz)	$ S_{11} $	$\angle S_{11}$	$ S_{21} $	$\angle S_{21}$	$ S_{12} $	$\angle S_{12}$	$ S_{22} $	$\angle S_{22}$
50	0.783	-164	10.63	89	0.027	-2	0.762	-164
100	0.831	-170	5.23	77	0.027	-12	0.775	-170
150	0.857	-173	3.36	68	0.026	-18	0.784	-171
200	0.873	-174	2.40	60	0.024	-24	0.810	-172
250	0.886	-175	1.82	54	0.022	-30	0.827	-172
300	0.899	-176	1.43	47	0.020	-34	0.852	-173
350	0.909	-177	1.15	42	0.018	-37	0.870	-174
400	0.921	-178	0.95	37	0.016	-41	0.882	-175
450	0.928	-179	0.80	33	0.015	-44	0.896	-175
500	0.937	-180	0.67	28	0.013	-45	0.911	-177
550	0.943	179	0.58	25	0.011	-45	0.920	-177
600	0.947	178	0.50	22	0.010	-48	0.929	-178
650	0.954	177	0.44	19	0.008	-45	0.935	-179
700	0.956	177	0.39	16	0.008	-45	0.941	180
750	0.959	176	0.34	14	0.006	-42	0.945	179
800	0.960	175	0.31	11	0.005	-35	0.947	18
850	0.964	174	0.28	9	0.005	-26	0.954	177
900	0.965	173	0.25	7	0.004	-7	0.955	177
950	0.968	173	0.23	6	0.003	-6	0.958	176
1000	0.969	172	0.21	4	0.003	16	0.959	175
1050	0.968	171	0.19	2	0.003	27	0.965	175
1100	0.969	171	0.18	1	0.004	42	0.963	174
1150	0.968	170	0.16	0	0.004	52	0.961	174
1200	0.970	169	0.15	-2	0.005	61	0.962	173
1250	0.969	169	0.14	-3	0.006	65	0.965	172
1300	0.969	168	0.13	-5	0.006	67	0.969	172
1350	0.968	167	0.12	-6	0.007	69	0.963	171
1400	0.967	167	0.11	-7	0.007	76	0.964	170
1450	0.966	166	0.11	-8	0.009	78	0.962	170
1500	0.962	166	0.10	-8	0.009	91	0.961	169

Table 10. S-parameter for PD55015-E ($V_{DS} = 12.5\text{ V}$ $I_{DS} = 1.2\text{ A}$)

Freq (MHz)	S ₁₁	S ₁₁ < Φ	S ₂₁	S ₂₁ < Φ	S ₁₂	S ₁₂ < Φ	S ₂₂	S ₂₂ < Φ
50	0.837	-171	11.65	85	0.015	0	0.845	-173
100	0.882	-174	5.65	79	0.014	-6	0.848	-176
150	0.904	-177	3.81	75	0.014	-7	0.848	-177
200	0.913	-178	2.82	71	0.014	-10	0.858	-178
250	0.915	-179	2.22	66	0.014	-12	0.859	-178
300	0.919	-173	1.82	61	0.012	-13	0.869	-179
350	0.924	179	1.52	56	0.012	-16	0.875	-179
400	0.928	179	1.30	52	0.011	-17	0.880	-179
450	0.931	178	1.11	48	0.011	-17	0.890	-180
500	0.934	178	0.97	44	0.010	-16	0.897	180
550	0.938	177	0.86	40	0.009	-15	0.902	179
600	0.943	176	0.75	37	0.008	-15	0.911	179
650	0.945	176	0.68	34	0.007	-10	0.916	178
700	0.948	175	0.61	31	0.007	-5	0.919	178
750	0.950	174	0.55	28	0.006	0	0.924	177
800	0.953	174	0.50	26	0.006	6	0.925	177
850	0.954	173	0.46	23	0.006	12	0.932	176
900	0.954	172	0.42	21	0.006	22	0.937	176
950	0.959	172	0.39	19	0.006	26	0.939	175
1000	0.959	171	0.36	17	0.006	36	0.938	174
1050	0.959	170	0.33	14	0.007	36	0.947	174
1100	0.960	170	0.31	12	0.006	43	0.948	173
1150	0.960	169	0.29	11	0.006	48	0.946	173
1200	0.962	169	0.27	9	0.007	53	0.947	172
1250	0.961	168	0.25	6	0.008	59	0.950	172
1300	0.961	167	0.24	4	0.009	63	0.954	171
1350	0.961	167	0.22	2	0.009	62	0.949	170
1400	0.959	166	0.21	1	0.009	67	0.952	170
1450	0.959	166	0.19	-1	0.010	72	0.949	169
1500	0.955	165	0.18	-1	0.010	80	0.947	169

Table 11. S-parameter for PD55015-E ($V_{DS} = 12.5\text{ V}$ $I_{DS} = 2.25\text{ A}$)

Freq (MHz)	S ₁₁	S ₁₁ < Φ	S ₂₁	S ₂₁ < Φ	S ₁₂	S ₁₂ < Φ	S ₂₂	S ₂₂ < Φ
50	0.845	-172	11.69	85	0.013	0	0.858	-174
100	0.891	-175	5.68	80	0.012	-3	0.862	-177
150	0.913	-177	3.84	76	0.012	-4	0.860	-178
200	0.923	-179	2.85	73	0.012	-6	0.866	-179
250	0.924	-180	2.25	67	0.012	-8	0.870	-179
300	0.927	180	1.86	63	0.011	-9	0.876	-179
350	0.930	179	1.55	59	0.011	-10	0.879	-180
400	0.933	178	1.33	55	0.010	-10	0.885	-180
450	0.935	178	1.15	50	0.010	-10	0.892	180
500	0.938	177	1.01	47	0.009	-9	0.898	179
550	0.940	176	0.89	43	0.008	-8	0.904	179
600	0.945	176	0.79	40	0.008	-5	0.912	178
650	0.948	175	0.71	37	0.073	-3	0.915	178
700	0.950	174	0.64	34	0.007	3	0.917	177
750	0.951	174	0.58	31	0.006	9	0.923	177
800	0.953	173	0.53	29	0.006	11	0.925	176
850	0.954	173	0.48	26	0.006	18	0.931	176
900	0.954	172	0.45	23	0.006	24	0.934	175
950	0.957	171	0.41	21	0.007	25	0.936	174
1000	0.959	171	0.38	19	0.007	36	0.939	174
1050	0.959	170	0.36	17	0.007	43	0.942	174
1100	0.960	170	0.33	15	0.007	47	0.943	173
1150	0.959	169	0.31	12	0.007	52	0.943	173
1200	0.961	168	0.29	11	0.007	53	0.943	172
1250	0.960	168	0.27	8	0.008	59	0.949	171
1300	0.961	167	0.26	6	0.009	60	0.950	171
1350	0.960	167	0.24	4	0.009	61	0.947	170
1400	0.592	166	0.22	2	0.009	64	0.945	170
1450	0.584	166	0.21	1	0.010	71	0.947	169
1500	0.954	165	0.19	0	0.010	82	0.945	168

Table 12. S-parameter for PD55015S-E ($V_{DS} = 12.5\text{ V}$ $I_{DS} = 225\text{ mA}$)

Freq (MHz)	S ₁₁	S ₁₁ < Φ	S ₂₁	S ₂₁ < Φ	S ₁₂	S ₁₂ < Φ	S ₂₂	S ₂₂ < Φ
50	0.769	-161	12.12	85	0.027	-3	0.730	-160
100	0.820	-167	5.77	74	0.026	-14	0.746	-166
150	0.847	-170	3.75	66	0.025	-21	0.769	-167
200	0.869	-172	2.66	59	0.023	-29	0.798	-168
250	0.884	-172	2.00	51	0.022	-34	0.851	-168
300	0.900	-173	1.56	45	0.019	-39	0.849	-169
350	0.914	-174	1.25	40	0.018	-43	0.872	-171
400	0.925	-175	1.02	35	0.016	-47	0.890	-171
450	0.936	-176	0.84	31	0.014	-50	0.905	-172
500	0.944	-176	0.71	28	0.013	-51	0.919	-173
550	0.950	-177	0.61	24	0.011	-53	0.927	-174
600	0.955	-178	0.52	22	0.010	-56	0.940	-175
650	0.960	-179	0.46	19	0.008	-55	0.941	-176
700	0.963	-179	0.40	17	0.007	-58	0.950	-177
750	0.965	-180	0.35	14	0.007	-57	0.952	-177
800	0.970	180	0.32	13	0.005	-52	0.959	-178
850	0.970	179	0.29	11	0.005	-55	0.956	-178
900	0.973	179	0.26	9	0.004	-45	0.965	-179
950	0.974	178	0.23	8	0.003	-31	0.964	-180
1000	0.976	178	0.21	6	0.003	-30	0.965	180
1050	0.978	177	0.20	5	0.002	-27	0.967	179
1100	0.977	177	0.18	3	0.001	-13	0.970	179
1150	0.979	176	0.17	3	0.002	18	0.971	179
1200	0.979	176	0.16	1	0.002	42	0.966	179
1250	0.979	176	0.15	0	0.002	64	0.984	179
1300	0.979	175	0.14	-2	0.003	75	0.991	176
1350	0.980	175	0.13	-3	0.003	93	0.974	177
1400	0.979	175	0.12	-3	0.004	90	0.975	176
1450	0.976	174	0.11	-4	0.004	102	0.972	176
1500	0.978	174	0.10	-4	0.006	112	0.976	175

Table 13. S-parameter PD55015S-E ($V_{DS} = 12.5\text{ V}$ $I_{DS} = 1.2\text{ A}$)

Freq (MHz)	$ S_{11} $	$S_{11} < \Phi$	$ S_{21} $	$S_{21} < \Phi$	$ S_{12} $	$S_{12} < \Phi$	$ S_{22} $	$S_{22} < \Phi$
50	0.826	-170	13.80	85	0.015	0	0.821	-171
100	0.872	-173	6.68	79	0.014	-6	0.824	-174
150	0.893	-175	4.49	74	0.014	-11	0.828	-175
200	0.905	-176	3.30	70	0.014	-15	0.838	-176
250	0.907	-177	2.59	64	0.013	-17	0.843	-176
300	0.914	-178	2.11	60	0.012	-20	0.856	-176
350	0.920	-178	1.74	55	0.012	-22	0.867	-176
400	0.925	-178	1.47	51	0.011	-25	0.876	-176
450	0.931	-179	1.26	46	0.010	-28	0.884	-177
500	0.937	-179	1.09	43	0.009	-30	0.895	-177
550	0.940	-180	0.95	39	0.008	-29	0.904	-177
600	0.945	-180	0.84	36	0.007	-31	0.915	-177
650	0.949	180	0.75	33	0.007	-26	0.915	-178
700	0.953	179	0.67	31	0.006	-27	0.926	-178
750	0.955	179	0.60	28	0.005	-25	0.929	-179
800	0.959	178	0.54	26	0.005	-20	0.936	-179
850	0.961	178	0.49	24	0.004	-14	0.934	-180
900	0.962	178	0.45	22	0.004	-4	0.944	180
950	0.964	177	0.42	20	0.004	1	0.943	180
1000	0.967	177	0.38	18	0.004	6	0.945	179
1050	0.968	176	0.35	16	0.003	16	0.948	179
1100	0.965	176	0.33	14	0.003	40	0.952	178
1150	0.970	176	0.31	13	0.003	36	0.955	179
1200	0.971	175	0.29	11	0.003	59	0.954	179
1250	0.971	175	0.27	9	0.004	60	0.971	178
1300	0.970	175	0.25	7	0.004	63	0.975	176
1350	0.972	174	0.24	5	0.004	67	0.959	176
1400	0.971	174	0.22	4	0.005	76	0.960	176
1450	0.970	174	0.20	3	0.005	88	0.961	175
1500	0.970	174	0.19	2	0.006	103	0.963	175

Table 14. S-parameter for PD55015S-E ($V_{DS} = 12.5\text{ V}$ $I_{DS} = 2.25\text{ A}$)

Freq (MHz)	S ₁₁	S ₁₁ < Φ	S ₂₁	S ₂₁ < Φ	S ₁₂	S ₁₂ < Φ	S ₂₂	S ₂₂ < Φ
50	0.838	-171	13.85	85	0.013	0	0.837	-173
100	0.882	-174	6.71	80	0.012	-7	0.839	-175
150	0.903	-176	4.53	76	0.012	-7	0.841	-176
200	0.914	-177	3.35	72	0.012	-11	0.849	-176
250	0.915	-178	2.64	66	0.012	-13	0.853	-177
300	0.920	-178	2.16	62	0.011	-17	0.861	-177
350	0.925	-179	1.79	57	0.010	-17	0.871	-177
400	0.929	-179	1.53	53	0.010	-21	0.877	-177
450	0.934	-179	1.31	49	0.009	-22	0.887	-177
500	0.937	-180	1.14	46	0.008	-23	0.894	-177
550	0.940	180	1.00	42	0.008	-22	0.903	-178
600	0.947	180	0.89	39	0.007	-20	0.913	-178
650	0.950	179	0.79	36	0.006	-19	0.913	-178
700	0.951	179	0.71	34	0.006	-19	0.921	-179
750	0.954	179	0.64	31	0.005	-15	0.927	-179
800	0.958	178	0.58	29	0.005	-8	0.932	-179
850	0.959	178	0.53	26	0.004	-3	0.930	180
900	0.962	177	0.48	24	0.004	0	0.940	179
950	0.964	177	0.45	22	0.004	7	0.941	179
1000	0.966	177	0.41	20	0.004	16	0.939	179
1050	0.967	176	0.38	18	0.004	23	0.946	178
1100	0.965	176	0.36	17	0.003	40	0.950	178
1150	0.967	176	0.33	15	0.003	41	0.952	179
1200	0.970	175	0.32	13	0.004	58	0.950	178
1250	0.971	175	0.30	11	0.004	59	0.966	178
1300	0.693	175	0.27	8	0.004	57	0.973	176
1350	0.972	174	0.26	7	0.005	68	0.957	176
1400	0.971	174	0.24	6	0.005	76	0.958	176
1450	0.969	174	0.22	5	0.005	88	0.957	175
1500	0.969	173	0.21	4	0.007	99	0.961	175

8 Package mechanical data

In order to meet environmental requirements, ST offers these devices in different grades of ECOPACK[®] packages, depending on their level of environmental compliance. ECOPACK[®] specifications, grade definitions and product status are available at: www.st.com. ECOPACK[®] is an ST trademark.

Table 15. PowerSO-10RF Formed lead (Gull Wing) Mechanical data

Dim.	mm.			Inch		
	Min.	Typ.	Max.	Min.	Typ.	Max.
A1	0	0.05	0.1	0.	0.0019	0.0038
A2	3.4	3.5	3.6	0.134	0.137	0.142
A3	1.2	1.3	1.4	0.046	0.05	0.054
A4	0.15	0.2	0.25	0.005	0.007	0.009
a		0.2			0.007	
b	5.4	5.53	5.65	0.212	0.217	0.221
c	0.23	0.27	0.32	0.008	0.01	0.012
D	9.4	9.5	9.6	0.370	0.374	0.377
D1	7.4	7.5	7.6	0.290	0.295	0.298
E	13.85	14.1	14.35	0.544	0.555	0.565
E1	9.3	9.4	9.5	0.365	0.37	0.375
E2	7.3	7.4	7.5	0.286	0.292	0.294
E3	5.9	6.1	6.3	0.231	0.24	0.247
F		0.5			0.019	
G		1.2			0.047	
L	0.8	1	1.1	0.030	0.039	0.042
R1			0.25			0.01
R2		0.8			0.031	
T	2 deg	5 deg	8 deg	2 deg	5 deg	8 deg
T1		6 deg			6 deg	
T2		10 deg			10 deg	

Note: Resin protrusions not included (max value: 0.15 mm per side)

Figure 30. Package dimensions

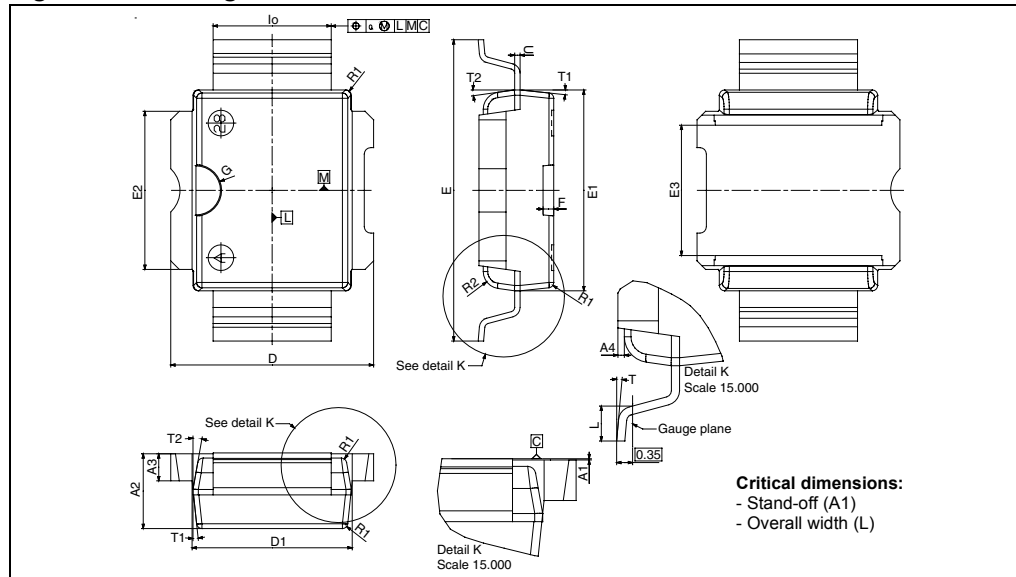

Table 16. PowerSO-10RF straight lead mechanical data

Dim.	mm.			Inch		
	Min.	Typ.	Max.	Min.	Typ.	Max.
A1	1.62	1.67	1.72	0.064	0.065	0.068
A2	3.4	3.5	3.6	0.134	0.137	0.142
A3	1.2	1.3	1.4	0.046	0.05	0.054
A4	0.15	0.2	0.25	0.005	0.007	0.009
a		0.2			0.007	
b	5.4	5.53	5.65	0.212	0.217	0.221
c	0.23	0.27	0.32	0.008	0.01	0.012
D	9.4	9.5	9.6	0.370	0.374	0.377
D1	7.4	7.5	7.6	0.290	0.295	0.298
E	15.15	15.4	15.65	0.595	0.606	0.615
E1	9.3	9.4	9.5	0.365	0.37	0.375
E2	7.3	7.4	7.5	0.286	0.292	0.294
E3	5.9	6.1	6.3	0.231	0.24	0.247
F		0.5			0.019	
G		1.2			0.047	
R1			0.25			0.01
R2		0.8			0.031	
T1		6 deg			6 deg	
T2		10 deg			10 deg	

Note: Resin protrusions not included (max value: 0.15 mm per side)

Figure 31. Package dimensions

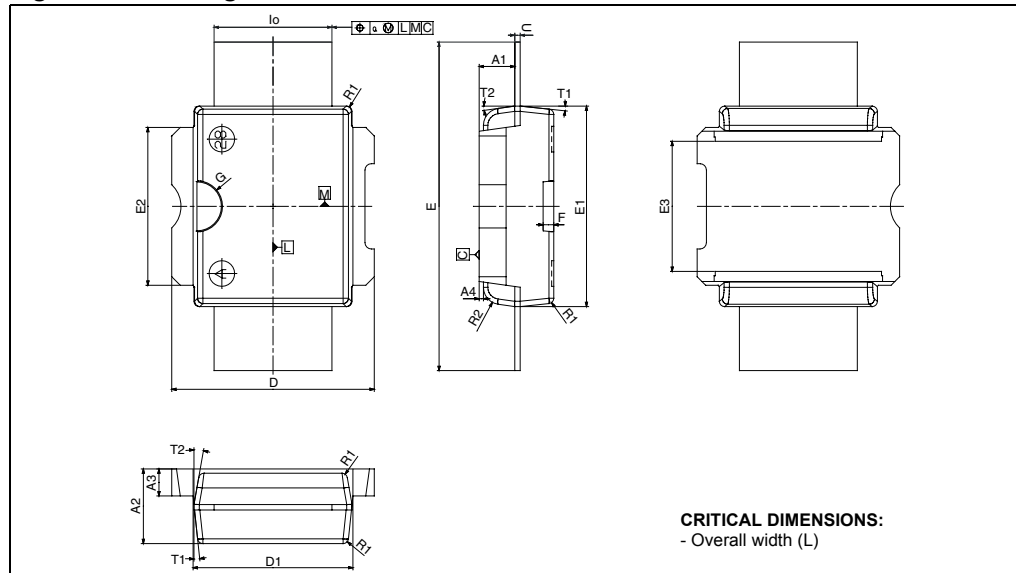

Figure 32. Tube information

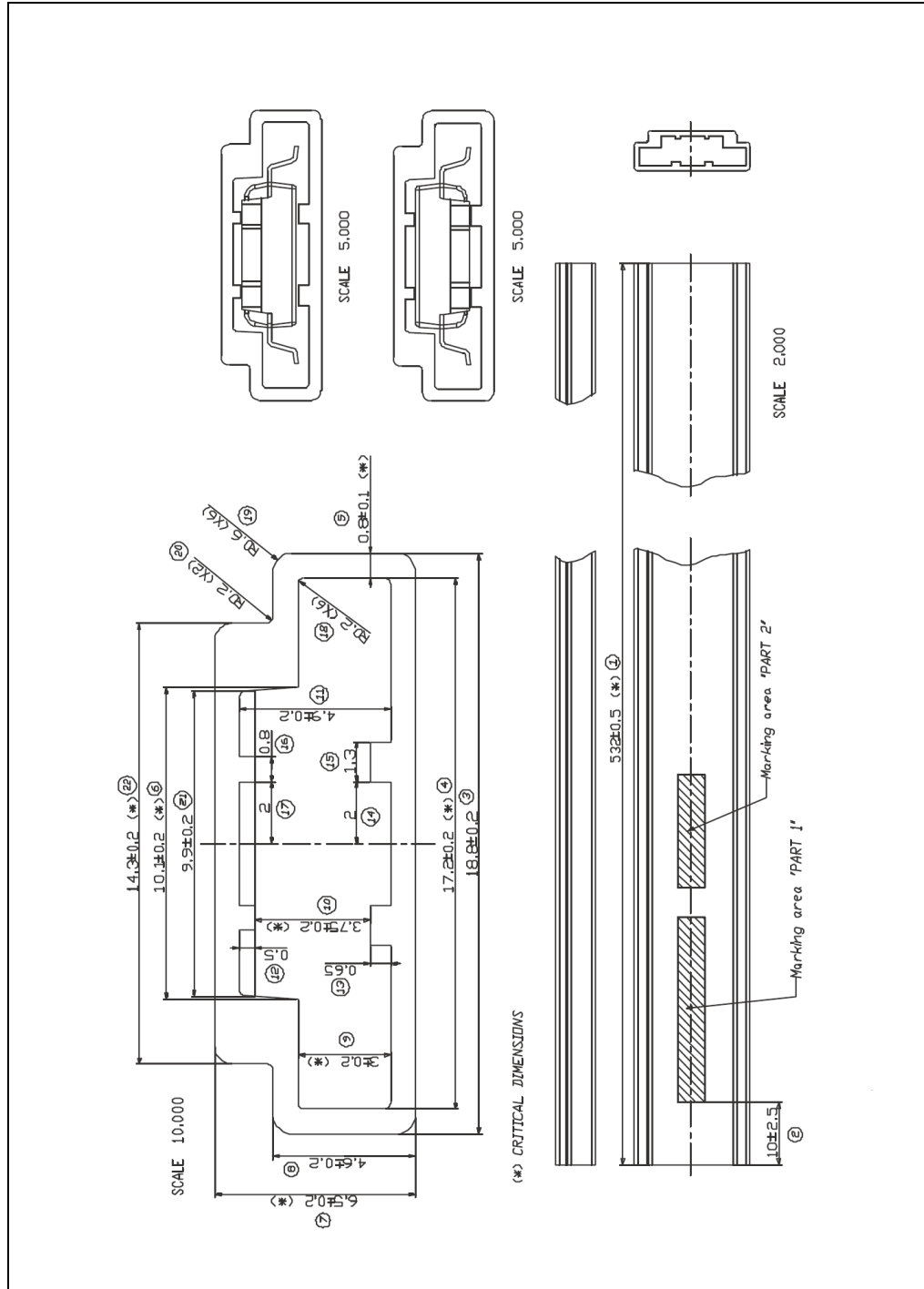
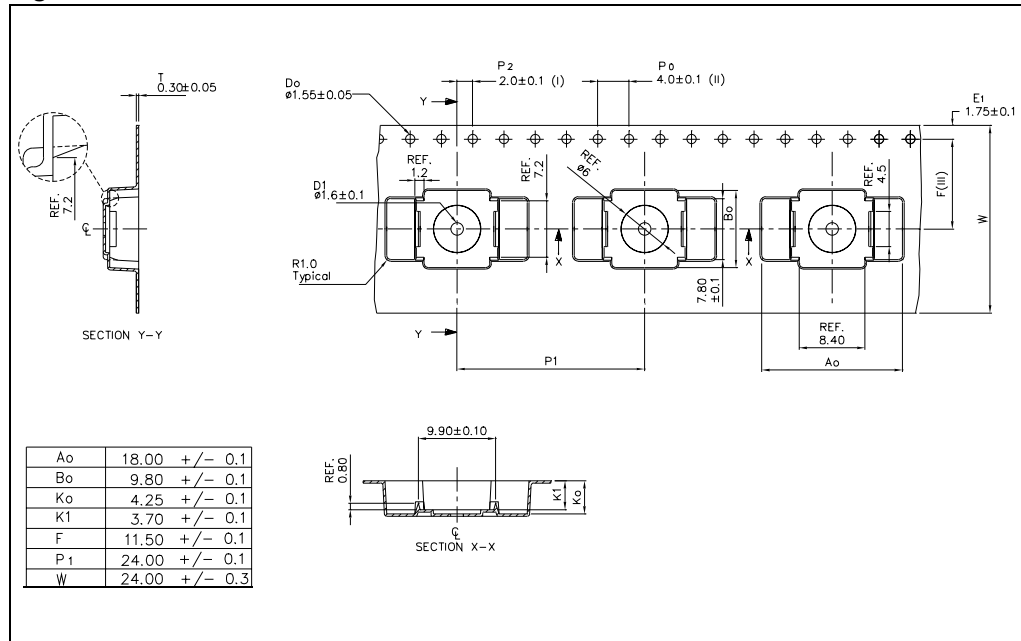

Figure 33. Reel information



9 Revision history

Table 17. Document revision history

Date	Revision	Changes
03-Aug-2006	1	Initial release.
26-May-2010	2	Added: Table 6: Moisture sensitivity level.

Please Read Carefully:

Information in this document is provided solely in connection with ST products. STMicroelectronics NV and its subsidiaries ("ST") reserve the right to make changes, corrections, modifications or improvements, to this document, and the products and services described herein at any time, without notice.

All ST products are sold pursuant to ST's terms and conditions of sale.

Purchasers are solely responsible for the choice, selection and use of the ST products and services described herein, and ST assumes no liability whatsoever relating to the choice, selection or use of the ST products and services described herein.

No license, express or implied, by estoppel or otherwise, to any intellectual property rights is granted under this document. If any part of this document refers to any third party products or services it shall not be deemed a license grant by ST for the use of such third party products or services, or any intellectual property contained therein or considered as a warranty covering the use in any manner whatsoever of such third party products or services or any intellectual property contained therein.

UNLESS OTHERWISE SET FORTH IN ST'S TERMS AND CONDITIONS OF SALE ST DISCLAIMS ANY EXPRESS OR IMPLIED WARRANTY WITH RESPECT TO THE USE AND/OR SALE OF ST PRODUCTS INCLUDING WITHOUT LIMITATION IMPLIED WARRANTIES OF MERCHANTABILITY, FITNESS FOR A PARTICULAR PURPOSE (AND THEIR EQUIVALENTS UNDER THE LAWS OF ANY JURISDICTION), OR INFRINGEMENT OF ANY PATENT, COPYRIGHT OR OTHER INTELLECTUAL PROPERTY RIGHT.

UNLESS EXPRESSLY APPROVED IN WRITING BY AN AUTHORIZED ST REPRESENTATIVE, ST PRODUCTS ARE NOT RECOMMENDED, AUTHORIZED OR WARRANTED FOR USE IN MILITARY, AIR CRAFT, SPACE, LIFE SAVING, OR LIFE SUSTAINING APPLICATIONS, NOR IN PRODUCTS OR SYSTEMS WHERE FAILURE OR MALFUNCTION MAY RESULT IN PERSONAL INJURY, DEATH, OR SEVERE PROPERTY OR ENVIRONMENTAL DAMAGE. ST PRODUCTS WHICH ARE NOT SPECIFIED AS "AUTOMOTIVE GRADE" MAY ONLY BE USED IN AUTOMOTIVE APPLICATIONS AT USER'S OWN RISK.

Resale of ST products with provisions different from the statements and/or technical features set forth in this document shall immediately void any warranty granted by ST for the ST product or service described herein and shall not create or extend in any manner whatsoever, any liability of ST.

ST and the ST logo are trademarks or registered trademarks of ST in various countries.

Information in this document supersedes and replaces all information previously supplied.

The ST logo is a registered trademark of STMicroelectronics. All other names are the property of their respective owners.

© 2010 STMicroelectronics - All rights reserved

STMicroelectronics group of companies

Australia - Belgium - Brazil - Canada - China - Czech Republic - Finland - France - Germany - Hong Kong - India - Israel - Italy - Japan - Malaysia - Malta - Morocco - Philippines - Singapore - Spain - Sweden - Switzerland - United Kingdom - United States of America

www.st.com

