

MC74HC573A

Octal 3-State Noninverting Transparent Latch

High-Performance Silicon-Gate CMOS

The MC74HC573A is identical in pinout to the LS573. The devices are compatible with standard CMOS outputs; with pullup resistors, they are compatible with LSTTL outputs.

These latches appear transparent to data (i.e., the outputs change asynchronously) when Latch Enable is high. When Latch Enable goes low, data meeting the setup and hold time becomes latched.

The HC573A is identical in function to the HC373A but has the data inputs on the opposite side of the package from the outputs to facilitate PC board layout.

Features

- Output Drive Capability: 15 LSTTL Loads
- Outputs Directly Interface to CMOS, NMOS and TTL
- Operating Voltage Range: 2.0 to 6.0 V
- Low Input Current: 1.0 μ A
- In Compliance with the JEDEC Standard No. 7.0 A Requirements
- Chip Complexity: 218 FETs or 54.5 Equivalent Gates
- Pb-Free Packages are Available*



ON Semiconductor®

MARKING DIAGRAMS

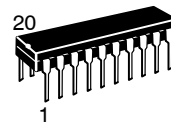

PDIP-20
N SUFFIX
CASE 738

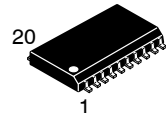
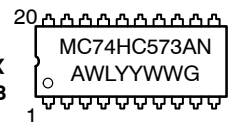

SOIC-20
DW SUFFIX
CASE 751D

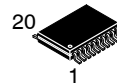
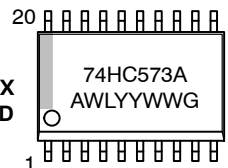

TSSOP-20
DT SUFFIX
CASE 948E

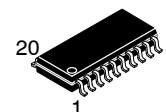
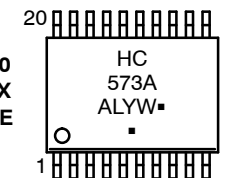

SOEIAJ-20
F SUFFIX
CASE 967

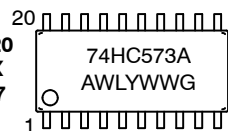

A = Assembly Location
WL, L = Wafer Lot
YY, Y = Year
WW, W = Work Week
G = Pb-Free Package
▪ = Pb-Free Package
(Note: Microdot may be in either location)

ORDERING INFORMATION

See detailed ordering and shipping information in the package dimensions section on page 2 of this data sheet.

*For additional information on our Pb-Free strategy and soldering details, please download the ON Semiconductor Soldering and Mounting Techniques Reference Manual, SOLDERRM/D.

MC74HC573A

PIN ASSIGNMENT

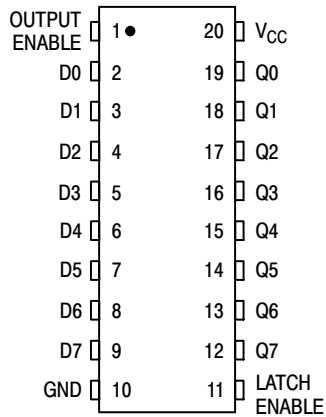

Design Criteria	Value	Units
Internal Gate Count*	54.5	ea.
Internal Gate Propagation Delay	1.5	ns
Internal Gate Power Dissipation	5.0	μ W
Speed Power Product	0.0075	pJ

*Equivalent to a two-input NAND gate.

FUNCTION TABLE

Inputs			Output
Output Enable	Latch Enable	D	Q
L	H	H	H
L	H	L	L
L	L	X	No Change
H	X	X	Z

X = Don't Care

Z = High Impedance

LOGIC DIAGRAM

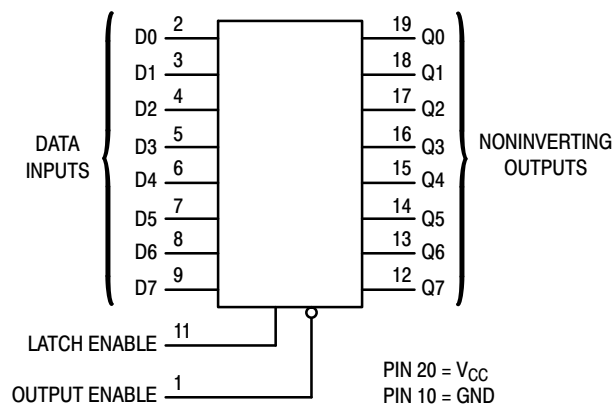

ORDERING INFORMATION

Device	Package	Shipping [†]
MC74HC573AN	PDIP-20	18 Units / Rail
MC74HC573ANG	SOIC-20 (Pb-Free)	18 Units / Rail
MC74HC573ADW	SOIC-20 WIDE	38 Units / Rail
MC74HC573ADWG	SOIC-20 WIDE (Pb-Free)	38 Units / Rail
MC74HC573ADWR2	SOIC-20 WIDE	1000 Tape & Reel
MC74HC573ADWR2G	SOIC-20 WIDE (Pb-Free)	1000 Tape & Reel
MC74HC573ADT	TSSOP-20*	75 Units / Rail
MC74HC573ADTG	TSSOP-20*	75 Units / Rail
MC74HC573ADTR2	TSSOP-20*	2500 Tape & Reel
MC74HC573ADTR2G	TSSOP-20*	2500 Tape & Reel
MC74HC573AFEL	SOEIAJ-20	2000 Tape & Reel
MC74HC573AFELG	SOEIAJ-20 (Pb-Free)	2000 Tape & Reel

[†]For information on tape and reel specifications, including part orientation and tape sizes, please refer to our Tape and Reel Packaging Specifications Brochure, BRD8011/D.

*This package is inherently Pb-Free.

MC74HC573A

MAXIMUM RATINGS

Symbol	Parameter	Value	Unit
V_{CC}	DC Supply Voltage (Referenced to GND)	- 0.5 to + 7.0	V
V_{in}	DC Input Voltage (Referenced to GND)	- 0.5 to $V_{CC} + 0.5$	V
V_{out}	DC Output Voltage (Referenced to GND)	- 0.5 to $V_{CC} + 0.5$	V
I_{in}	DC Input Current, per Pin	± 20	mA
I_{out}	DC Output Current, per Pin	± 35	mA
I_{CC}	DC Supply Current, V_{CC} and GND Pins	± 75	mA
P_D	Power Dissipation in Still Air, Plastic DIP† SOIC Package† TSSOP Package†	750 500 450	mW
T_{stg}	Storage Temperature	- 65 to + 150	°C
T_L	Lead Temperature, 1 mm from Case for 10 Seconds (Plastic DIP, TSSOP or SOIC Package)	260	°C

This device contains protection circuitry to guard against damage due to high static voltages or electric fields. However, precautions must be taken to avoid applications of any voltage higher than maximum rated voltages to this high-impedance circuit. For proper operation, V_{in} and V_{out} should be constrained to the range $GND \leq (V_{in} \text{ or } V_{out}) \leq V_{CC}$. Unused inputs must always be tied to an appropriate logic voltage level (e.g., either GND or V_{CC}). Unused outputs must be left open.

Stresses exceeding Maximum Ratings may damage the device. Maximum Ratings are stress ratings only. Functional operation above the Recommended Operating Conditions is not implied. Extended exposure to stresses above the Recommended Operating Conditions may affect device reliability.

†Derating - Plastic DIP: -10 mW/°C from 65° to 125°C
SOIC Package: -7 mW/°C from 65° to 125°C
TSSOP Package: -6.1 mW/°C from 65° to 125°C

For high frequency or heavy load considerations, see Chapter 2 of the ON Semiconductor High-Speed CMOS Data Book (DL129/D).

RECOMMENDED OPERATING CONDITIONS

Symbol	Parameter	Min	Max	Unit
V_{CC}	DC Supply Voltage (Referenced to GND)	2.0	6.0	V
V_{in}, V_{out}	DC Input Voltage, Output Voltage (Referenced to GND)	0	V_{CC}	V
T_A	Operating Temperature, All Package Types	- 55	+ 125	°C
t_r, t_f	Input Rise and Fall Time (Figure 1)	$V_{CC} = 2.0 \text{ V}$ $V_{CC} = 4.5 \text{ V}$ $V_{CC} = 6.0 \text{ V}$	0 1000 500 400	ns

DC ELECTRICAL CHARACTERISTICS (Voltages Referenced to GND)

Symbol	Parameter	Test Conditions	V_{CC} V	Guaranteed Limit			Unit
				- 55 to 25°C	$\leq 85^\circ\text{C}$	$\leq 125^\circ\text{C}$	
V_{IH}	Minimum High-Level Input Voltage	$V_{out} = 0.1 \text{ V or } V_{CC} - 0.1 \text{ V}$ $ I_{out} \leq 20 \mu\text{A}$	2.0	1.5	1.5	1.5	V
			3.0	2.1	2.1	2.1	
			4.5	3.15	3.15	3.15	
			6.0	4.2	4.2	4.2	
V_{IL}	Maximum Low-Level Input Voltage	$V_{out} = 0.1 \text{ V or } V_{CC} - 0.1 \text{ V}$ $ I_{out} \leq 20 \mu\text{A}$	2.0	0.5	0.5	0.5	V
			3.0	0.9	0.9	0.9	
			4.5	1.35	1.35	1.35	
			6.0	1.8	1.8	1.8	
V_{OH}	Minimum High-Level Output Voltage	$V_{in} = V_{IH} \text{ or } V_{IL}$ $ I_{out} \leq 20 \mu\text{A}$	2.0	1.9	1.9	1.9	V
			4.5	4.4	4.4	4.4	
			6.0	5.9	5.9	5.9	
			$V_{in} = V_{IH} \text{ or } V_{IL}$ $ I_{out} \leq 2.4 \text{ mA}$ $ I_{out} \leq 6.0 \text{ mA}$ $ I_{out} \leq 7.8 \text{ mA}$	3.0	2.48	2.34	
V_{OL}	Maximum Low-Level Output Voltage	$V_{out} = 0.1 \text{ V or } V_{CC} - 0.1 \text{ V}$ $ I_{out} \leq 20 \mu\text{A}$	2.0	0.1	0.1	0.1	V
			4.5	0.1	0.1	0.1	
			6.0	0.1	0.1	0.1	
			$V_{in} = V_{IH} \text{ or } V_{IL}$ $ I_{out} \leq 2.4 \text{ mA}$ $ I_{out} \leq 6.0 \text{ mA}$ $ I_{out} \leq 7.8 \text{ mA}$	3.0	0.26	0.33	
I_{in}	Maximum Input Leakage Current	$V_{in} = V_{CC} \text{ or GND}$	6.0	± 0.1	± 1.0	± 1.0	μA
I_{OZ}	Maximum Three-State Leakage Current	Output in High-Impedance State $V_{in} = V_{IL} \text{ or } V_{IH}$ $V_{out} = V_{CC} \text{ or GND}$	6.0	- 0.5	- 5.0	- 10	μA
I_{CC}	Maximum Quiescent Supply Current (per Package)	$V_{in} = V_{CC} \text{ or GND}$ $I_{out} = 0 \mu\text{A}$	6.0	4.0	40	160	μA

NOTE: Information on typical parametric values can be found in Chapter 2 of the ON Semiconductor High-Speed CMOS Data Book (DL129/D).

MC74HC573A

AC ELECTRICAL CHARACTERISTICS ($C_L = 50$ pF, Input $t_r = t_f = 6.0$ ns)

Symbol	Parameter	V _{CC} V	Guaranteed Limit			Unit
			- 55 to 25 °C	≤ 85 °C	≤ 125 °C	
t _{PLH} , t _{PHL}	Maximum Propagation Delay, Input D to Q (Figures 1 and 5)	2.0	150	190	225	ns
		3.0	100	140	180	
		4.5	30	38	45	
		6.0	26	33	38	
t _{PLH} , t _{PHL}	Maximum Propagation Delay, Latch Enable to Q (Figures 2 and 5)	2.0	160	200	240	ns
		3.0	105	145	190	
		4.5	32	40	48	
		6.0	27	34	41	
t _{PLZ} , t _{PHZ}	Maximum Propagation Delay, Output Enable to Q (Figures 3 and 6)	2.0	150	190	225	ns
		3.0	100	125	150	
		4.5	30	38	45	
		6.0	26	33	38	
t _{PZL} , t _{PZH}	Maximum Propagation Delay, Output Enable to Q (Figures 3 and 6)	2.0	150	190	225	ns
		3.0	100	125	150	
		4.5	30	38	45	
		6.0	26	33	38	
t _{TLH} , t _{THL}	Maximum Output Transition Time, Any Output (Figures 1 and 5)	2.0	60	75	90	ns
		3.0	27	32	36	
		4.5	12	15	18	
		6.0	10	13	15	
C _{in}	Maximum Input Capacitance		10	10	10	pF
C _{out}	Maximum 3-State Output Capacitance (Output in High-Impedance State)		15	15	15	pF

NOTE: For propagation delays with loads other than 50 pF, and information on typical parametric values, see Chapter 2 of the ON Semiconductor High-Speed CMOS Data Book (DL129/D).

C _{PD}	Power Dissipation Capacitance (Per Enabled Output)*	Typical @ 25°C, V _{CC} = 5.0 V		pF
		23		

* Used to determine the no-load dynamic power consumption: $P_D = C_{PD} V_{CC}^2 f + I_{CC} V_{CC}$. For load considerations, see Chapter 2 of the ON Semiconductor High-Speed CMOS Data Book (DL129/D).

TIMING REQUIREMENTS ($C_L = 50$ pF, Input $t_r = t_f = 6.0$ ns)

Symbol	Parameter	Figure	V _{CC} V	Guaranteed Limit						Unit
				- 55 to 25 °C		≤ 85 °C		≤ 125 °C		
				Min	Max	Min	Max	Min	Max	
t _{su}	Minimum Setup Time, Input D to Latch Enable	4	2.0	50		65		75		ns
			3.0	40		50		60		
			4.5	10		13		15		
			6.0	9.0		11		13		
t _h	Minimum Hold Time, Latch Enable to Input D	4	2.0	5.0		5.0		5.0		ns
			3.0	5.0		5.0		5.0		
			4.5	5.0		5.0		5.0		
			6.0	5.0		5.0		5.0		
t _w	Minimum Pulse Width, Latch Enable	2	2.0	75		95		110		ns
			3.0	60		80		90		
			4.5	15		19		22		
			6.0	13		16		19		
t _r , t _f	Maximum Input Rise and Fall Times	1	2.0		1000		1000		1000	ns
			3.0		800		800		800	
			4.5		500		500		500	
			6.0		400		400		400	

MC74HC573A

PACKAGE DIMENSIONS

PDIP-20
N SUFFIX
CASE 738-03
ISSUE E

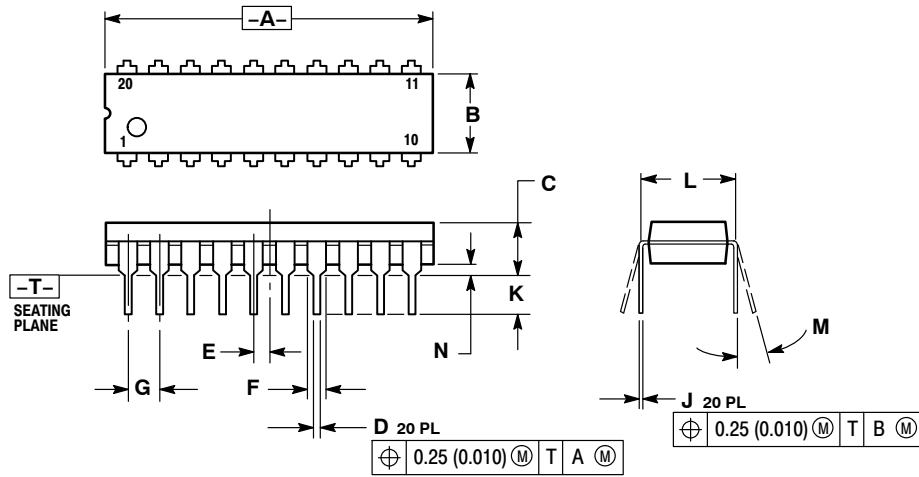

- NOTES:
1. DIMENSIONING AND TOLERANCING PER ANSI Y14.5M, 1982.
 2. CONTROLLING DIMENSION: INCH.
 3. DIMENSION L TO CENTER OF LEAD WHEN FORMED PARALLEL.
 4. DIMENSION B DOES NOT INCLUDE MOLD FLASH.

DIM	INCHES		MILLIMETERS	
	MIN	MAX	MIN	MAX
A	1.010	1.070	25.66	27.17
B	0.240	0.260	6.10	6.60
C	0.150	0.180	3.81	4.57
D	0.015	0.022	0.39	0.55
E	0.050 BSC		1.27 BSC	
F	0.050 0.070		1.27 1.77	
G	0.100 BSC 2.54 BSC			
J	0.008	0.015	0.21	0.38
K	0.110	0.140	2.80	3.55
L	0.300 BSC		7.62 BSC	
M	0° 15°		0° 15°	
N	0.020	0.040	0.51	1.01

SOIC-20
DW SUFFIX
CASE 751D-05
ISSUE G

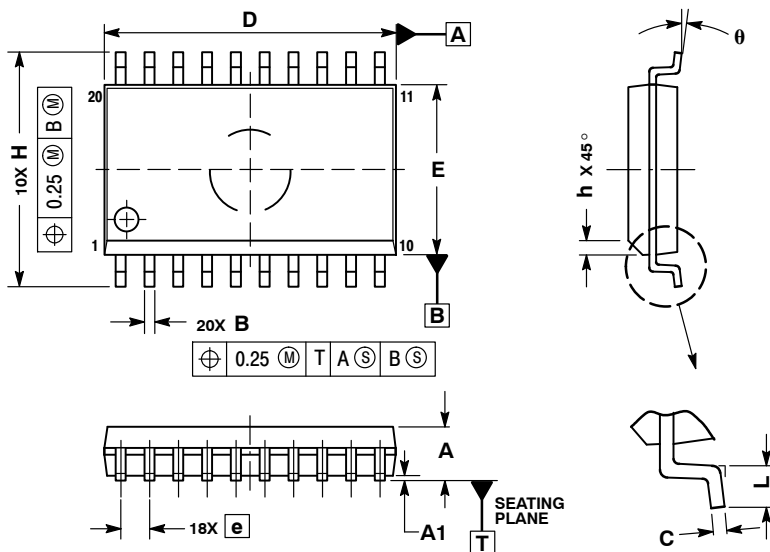

- NOTES:
1. DIMENSIONS ARE IN MILLIMETERS.
 2. INTERPRET DIMENSIONS AND TOLERANCES PER ASME Y14.5M, 1994.
 3. DIMENSIONS D AND E DO NOT INCLUDE MOLD PROTRUSION.
 4. MAXIMUM MOLD PROTRUSION 0.15 PER SIDE.
 5. DIMENSION B DOES NOT INCLUDE DAMBAR PROTRUSION. ALLOWABLE PROTRUSION SHALL BE 0.13 TOTAL IN EXCESS OF B DIMENSION AT MAXIMUM MATERIAL CONDITION.

DIM	MILLIMETERS	
	MIN	MAX
A	2.35	2.65
A1	0.10	0.25
B	0.35	0.49
C	0.23	0.32
D	12.65	12.95
E	7.40	7.60
e	1.27 BSC	
H	10.05	10.55
h	0.25	0.75
L	0.50	0.90
θ	0° 7°	