

FEATURES

- * 0.28 inch (7.0 mm) DIGIT HEIGHT.
- * CONTINUOUS UNIFORM SEGMENTS.
- * LOW POWER REQUIREMENT.
- * EXCELLENT CHARACTERS APPEARANCE.
- * HIGH BRIGHTNESS & HIGH CONTRAST.
- * WIDE VIEWING ANGLE.
- * SOLID STATE RELIABILITY.
- * CATEGORIZED FOR LUMINOUS INTENSITY.

DESCRIPTION

The LTC-2723JD is a 0.28 inch (7.0 mm) digit height quadruple digit seven-segment display. This device utilizes AlInGaP hi.-eff. red LED chips, which are made from AlInGaP on a non-transparent GaAs substrate, and has a gray face and white segments.

DEVICE

| PART NO. | DESCRIPTION |
|----------------------|--|
| AllnGaP HI.-EFF. RED | Multiplex Common Cathode Rt. Hand Decimal |
| LTC-2723JD | |

PACKAGE DIMENSIONS

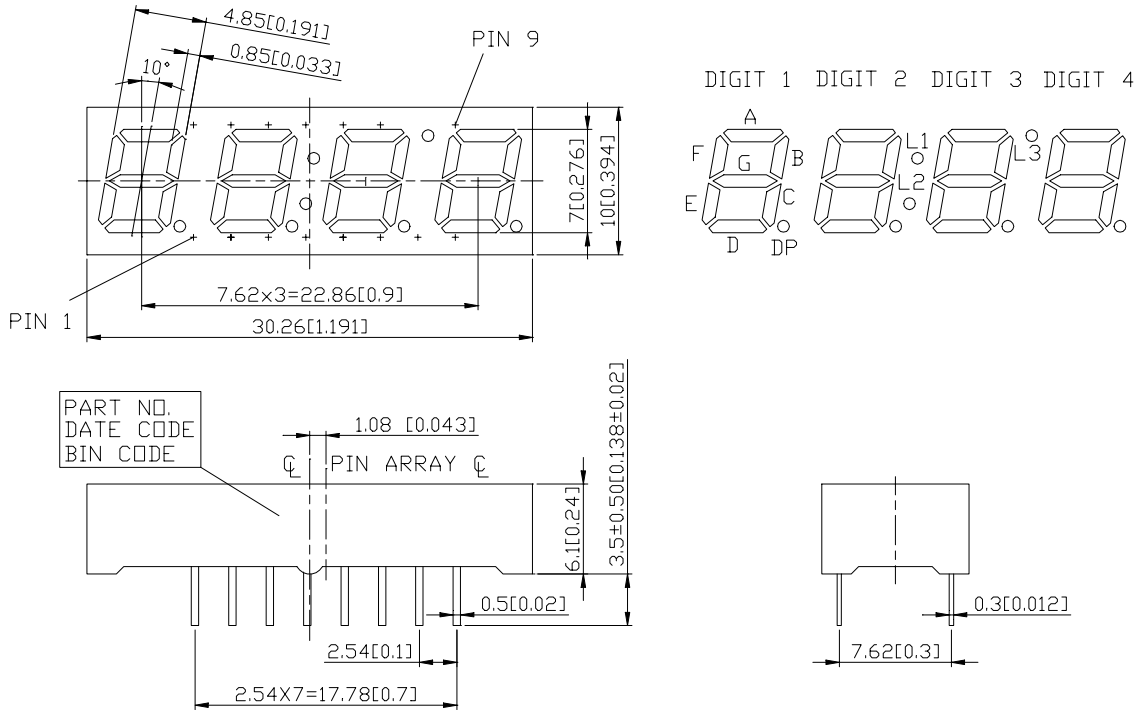

NOTES: All dimensions are in millimeters. Tolerances are ± 0.25 -mm (0.01“) unless otherwise noted.

INTERNAL CIRCUIT DIAGRAM

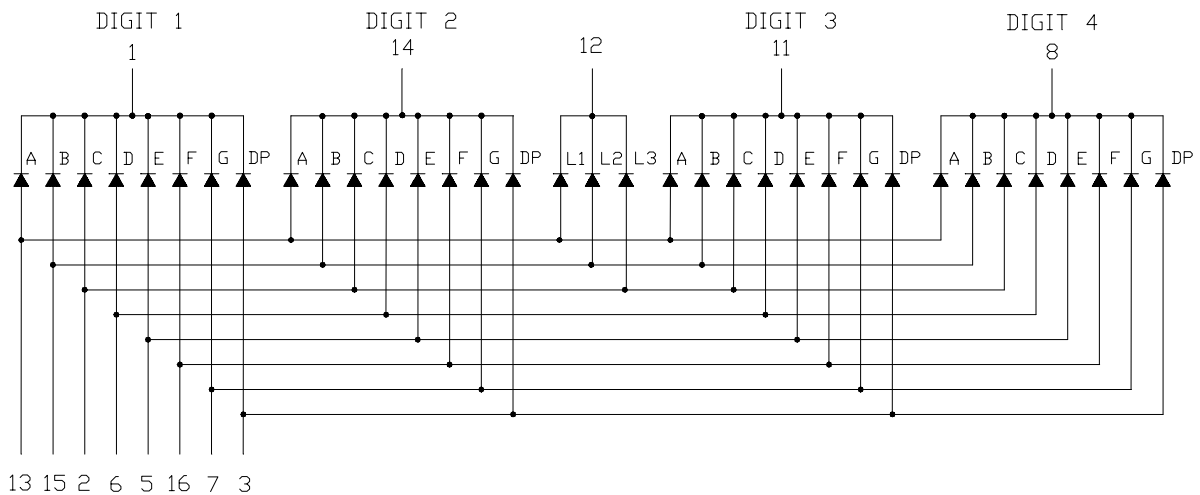

PIN CONNECTION

| NO | CONNECTION |
|-----------|---------------------------|
| 1 | COMMON CATHODE (DIGIT 1) |
| 2 | ANODE C, L3 |
| 3 | ANODE D.P. |
| 4 | NO CONNECTION |
| 5 | ANODE E |
| 6 | ANODE D |
| 7 | ANODE G |
| 8 | COMMON CATHODE (DIGIT 4) |
| 9 | NO CONNECTION |
| 10 | NO PIN |
| 11 | COMMON CATHODE (DIGIT 3) |
| 12 | COMMON CATHODE L1, L2, L3 |
| 13 | ANODE A, L1 |
| 14 | COMMON CATHODE (DIGIT 2) |
| 15 | ANODE B, L2 |
| 16 | ANODE F |

ABSOLUTE MAXIMUM RATING AT T_A=25°C

| PARAMETER | MAXIMUM RATING | UNIT |
|---|----------------|-------------|
| Power Dissipation Per Segment | 70 | mW |
| Peak Forward Current Per Segment (1/10 Duty Cycle, 0.1ms Pulse Width) | 100 | mA |
| Continuous Forward Current Per Segment Derating Linear From 25°C Per Segment | 25 0.33 | mA mA/°C |
| Reverse Voltage Per Segment | 5 | V |
| Operating Temperature Range | -35°C to +85°C | |
| Storage Temperature Range | -35°C to +85°C | |
| Solder Temperature 1/16 inch Below Seating Plane for 3 Seconds at 260°C | | |

ELECTRICAL / OPTICAL CHARACTERISTICS AT T_A=25°C

| PARAMETER | SYMBOL | MIN. | TYP. | MAX. | UNIT | TEST CONDITION |
|-----------------------------------|-------------------|------|------|------|------|----------------------|
| Average Luminous Intensity | I _v | 200 | 600 | | μcd | I _F =1mA |
| Peak Emission Wavelength | λ _p | | 656 | | nm | I _F =20mA |
| Spectral Line Half-Width | Δλ | | 22 | | nm | I _F =20mA |
| Dominant Wavelength | λ _d | | 640 | | nm | I _F =20mA |
| Forward Voltage Per Segment | V _F | | 2.1 | 2.6 | V | I _F =20mA |
| Reverse Current Per Segment | I _R | | | 10 | μA | V _R =5V |
| Luminous Intensity Matching Ratio | I _v -m | | | 2:1 | | I _F =10mA |

Note: Luminous intensity is measured with a light sensor and filter combination that approximates the CIE (Commision Internationale De L'Eclairage) eye-response curve.

TYPICAL ELECTRICAL / OPTICAL CHARACTERISTIC CURVES

(25°C Ambient Temperature Unless Otherwise Noted)

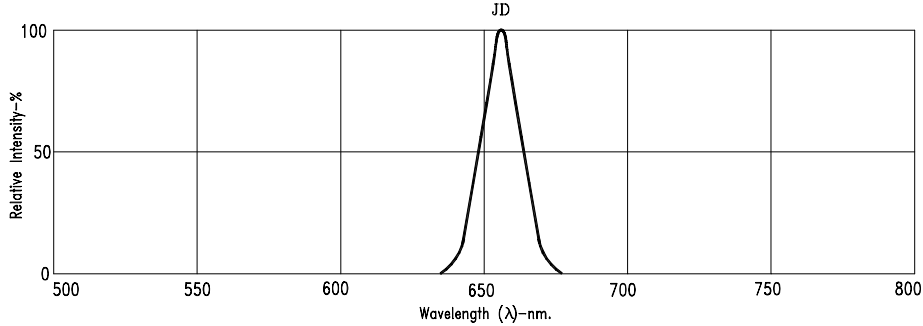

Fig1. RELATIVE INTENSITY VS. WAVELENGTH

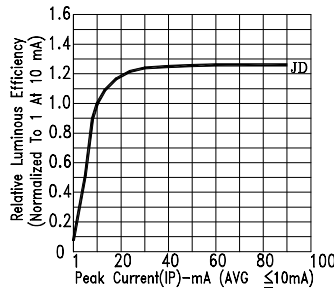

Fig2. RELATIVE LUMINOUS EFFICIENCY (LUMINOUS INTENSITY PER UNIT CURRENT) VS. PEAK CURRENT

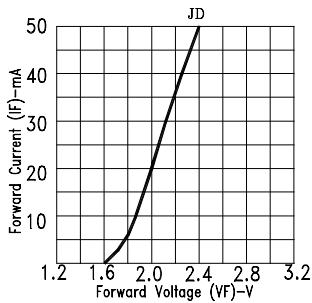

Fig3. FORWARD CURRENT VS. FORWARD VOLTAGE

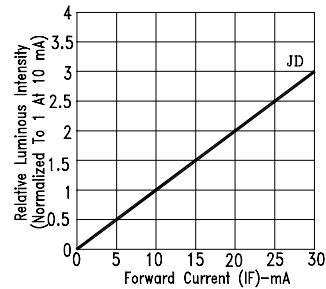

Fig4. RELATIVE LUMINOUS INTENSITY VS. FORWARD CURRENT

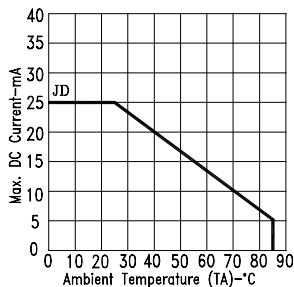

Fig5. MAX. ALLOWABLE DC CURRENT VS. AMBIENT TEMPERATURE.

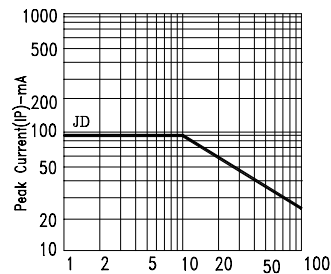

Fig6. MAX. PEAK CURRENT VS. DUTY CYCLE % (REFRESH RATE 1KHz)

NOTE : JD=AlInGaP HI-EFF. RED