

FEATURES

- Low Power: $I_{CC} = 300\mu\text{A}$ Typ
- Designed for RS485 Interface Applications
- Single 5V supply
- -7V to 12V Bus Common Mode Range Permits $\pm 7\text{V}$ Ground Difference Between Devices on the Bus
- Thermal Shutdown Protection
- Power-Up/Down Glitch-Free Driver Outputs Permit Live Insertion or Removal of Transceiver
- Driver Maintains High Impedance in Three-State or with the Power Off
- Combined Impedance of a Driver Output and Receiver Allows Up to 32 Transceivers on the Bus
- 70mV Typical Input Hysteresis
- 30ns Typical Driver Propagation Delays with 5ns Skew
- Pin Compatible with $\pm 60\text{V}$ Protected LT1785 and 52Mbps LTC1685

APPLICATIONS

- Low Power RS485/RS422 Transceiver
- Level Translator

DESCRIPTION

The LTC[®]485 is a low power differential bus/line transceiver designed for multipoint data transmission standard RS485 applications with extended common mode range (12V to -7V). It also meets the requirements of RS422.

The CMOS design offers significant power savings over its bipolar counterpart without sacrificing ruggedness against overload of ESD damage.

The driver and receiver feature three-state outputs, with the driver outputs maintaining high impedance over the entire common mode range. Excessive power dissipation caused by bus contention or faults is prevented by a thermal shutdown circuit which forces the driver outputs into a high impedance state.

The receiver has a fail-safe feature which guarantees a high output state when the inputs are left open.

The LTC485 is fully specified over the commercial and extended industrial temperature range.

LT, LTC and LT are registered trademarks of Linear Technology Corporation.

TYPICAL APPLICATION

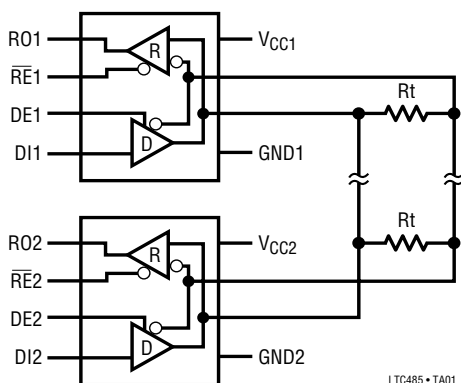

Driver Outputs

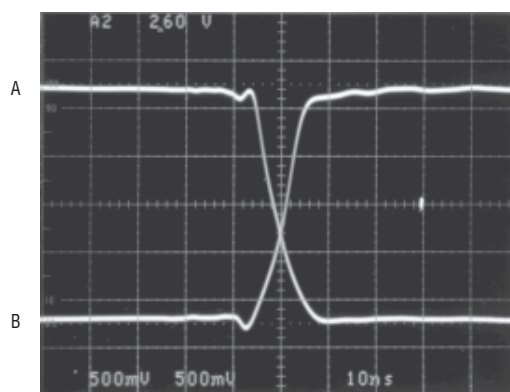

sn 485LTC485ffs

ABSOLUTE MAXIMUM RATINGS

(Note 1)

| | |
|--|---|
| Supply Voltage | 12V |
| Control Input Voltages | -0.5V to $V_{CC} + 0.5V$ |
| Driver Input Voltage | -0.5V to $V_{CC} + 0.5V$ |
| Driver Output Voltage | $\pm 14V$ |
| Receiver Input Voltage | $\pm 14V$ |
| Receiver Output Voltages | -0.5V to $V_{CC} + 0.5V$ |
| Operating Temperature Range | |
| LTC485I | $-40^{\circ}C \leq T_A \leq 85^{\circ}C$ |
| LTC485C | $0^{\circ}C \leq T_A \leq 70^{\circ}C$ |
| LTC485M (OBSOLETE) | $-55^{\circ}C \leq T_A \leq 125^{\circ}C$ |
| Lead Temperature (Soldering, 10 sec) | 300°C |

PACKAGE/ORDER INFORMATION

| | |
|---|--|
| <p>TOP VIEW</p> <p>RO 1, RE 2, DE 3, DI 4, 8 VCC, 7 B, 6 A, 5 GND</p> <p>N8 PACKAGE: 8-LEAD PLASTIC DIP S8 PACKAGE: 8-LEAD PLASTIC SOIC</p> <p>$T_{JMAX} = 125^{\circ}C, \theta_{JA} = 100^{\circ}C/W (N)$ $T_{JMAX} = 150^{\circ}C, \theta_{JA} = 150^{\circ}C/W (S)$</p> <p>J8 PACKAGE: 8-LEAD CERAMIC DIP $T_{JMAX} = 155^{\circ}C, \theta_{JA} = 100^{\circ}C/W (J)$</p> <p>OBSOLETE PACKAGE Consider the N8 Package for Alternate Source</p> | ORDER PART NUMBER |
| | LTC485CN8 LTC485CS8 LTC485IN8 LTC485IS8 |
| | S8 PART MARKING |
| | 485 485I |
| | ORDER PART NUMBER |
| | LTC485CJ8 LTC485MJ8 |

Consult LTC Marketing for parts specified with wider operating temperature ranges.

ELECTRICAL CHARACTERISTICS

The ● denotes the specifications which apply over the full operating temperature range, otherwise specifications are at $T_A = 25^{\circ}C$. $V_{CC} = 5V \pm 5\%$, unless otherwise noted. (Notes 2 and 3)

| SYMBOL | PARAMETER | CONDITIONS | MIN | TYP | MAX | UNITS |
|-------------------|--|--|--------|----------|-----------------|------------|
| V_{OD1} | Differential Driver Output Voltage (Unloaded) | $I_O = 0$ | ● | | 5 | V |
| V_{OD2} | Differential Driver Output Voltage (with Load) | $R = 50\Omega$ (RS422) $R = 27\Omega$ (RS485), Figure 1 | ● ● | 2 1.5 | 5 | V V |
| ΔV_{OD} | Change in Magnitude of Driver Differential Output Voltage for Complementary States | $R = 27\Omega$ or $R = 50\Omega$, Figure 1 | ● | | 0.2 | V |
| V_{OC} | Driver Common Mode Output Voltage | $R = 27\Omega$ or $R = 50\Omega$, Figure 1 | ● | | 3 | V |
| $\Delta V_{OC} $ | Change in Magnitude of Driver Common-Mode Output Voltage for Complementary States | $R = 27\Omega$ or $R = 50\Omega$, Figure 1 | ● | | 0.2 | V |
| V_{IH} | Input High Voltage | DE, DI, \overline{RE} | ● | 2 | | V |
| V_{IL} | Input Low Voltage | DE, DI, \overline{RE} | ● | | 0.8 | V |
| I_{IN1} | Input Current | DE, DI, \overline{RE} | ● | | ± 2 | μA |
| I_{IN2} | Input Current (A, B) | DE = 0, $V_{CC} = 0V$ or 5.25V | ● ● | | ± 1 -0.8 | mA mA |
| V_{TH} | Differential Input Threshold Voltage for Receiver | $-7V \leq V_{CM} \leq 12V$ | ● | -0.2 | 0.2 | V |
| ΔV_{TH} | Receiver Input Hysteresis | $V_{CM} = 0V$ | ● | 70 | | mV |
| V_{OH} | Receiver Output High Voltage | $I_O = -4mA, V_{ID} = 200mV$ | ● | 3.5 | | V |
| V_{OL} | Receiver Output Low Voltage | $I_O = 4mA, V_{ID} = -200mV$ | ● | | 0.4 | V |
| I_{OZR} | Three-State (High Impedance) Output Current at Receiver | $V_{CC} = \text{Max}, 0.4V \leq V_O \leq 2.4V$ | ● | | ± 1 | μA |
| R_{IN} | Receiver Input Resistance | $-7V \leq V_{CM} \leq 12V$ | ● | 12 | | k Ω |

SWITCHING CHARACTERISTICS

The ● denotes the specifications which apply over the full operating temperature range, otherwise specifications are at $T_A = 25^\circ\text{C}$, $V_{CC} = 5V \pm 5\%$, unless otherwise noted. (Notes 2 and 3)

| SYMBOL | PARAMETER | CONDITIONS | | MIN | TYP | MAX | UNITS |
|------------|---|---|--------------------|-----|-----|-----|---------------|
| I_{CC} | Supply Current | No Load, Pins 2, 3, 4 = 0V or 5V | Outputs Enabled ● | | 500 | 900 | μA |
| | | | Outputs Disabled ● | | 300 | 500 | μA |
| I_{OSD1} | Driver Short-Circuit Current, $V_{OUT} = \text{HIGH}$ | $V_O = -7V$ | ● | 35 | 100 | 250 | mA |
| I_{OSD2} | Driver Short-Circuit Current, $V_{OUT} = \text{LOW}$ | $V_O = 10V$ | ● | 35 | 100 | 250 | mA |
| I_{OSR} | Receiver Short-Circuit Current | $0V \leq V_O \leq V_{CC}$ | ● | 7 | | 85 | mA |
| t_{PLH} | Driver Input to Output | $R_{DIFF} = 54\Omega$, $C_{L1} = C_{L2} = 100\text{pF}$, (Figures 3 and 5) | ● | 10 | 30 | 50 | ns |
| t_{PHL} | Driver Input to Output | | ● | 10 | 30 | 50 | ns |
| t_{SKEW} | Driver Output to Output | | ● | | 5 | 10 | ns |
| t_r, t_f | Driver Rise or Fall Time | | ● | 3 | 15 | 25 | ns |
| t_{ZH} | Driver Enable to Output High | $C_L = 100\text{pF}$ (Figures 4 and 6) S2 Closed | ● | | 40 | 70 | ns |
| t_{ZL} | Driver Enable to Output Low | $C_L = 100\text{pF}$ (Figures 4 and 6) S1 Closed | ● | | 40 | 70 | ns |
| t_{LZ} | Driver Disable Time from Low | $C_L = 15\text{pF}$ (Figures 4 and 6) S1 Closed | ● | | 40 | 70 | ns |
| t_{HZ} | Driver Disable Time from High | $C_L = 15\text{pF}$ (Figures 4 and 6) S2 Closed | ● | | 40 | 70 | ns |
| t_{PLH} | Receiver Input to Output | $R_{DIFF} = 54\Omega$, $C_{L1} = C_{L2} = 100\text{pF}$, (Figures 3 and 7) | ● | 30 | 90 | 200 | ns |
| t_{PHL} | | | ● | 30 | 90 | 200 | ns |
| t_{SKD} | $ t_{PLH} - t_{PHL} $ Differential Receiver Skew | | ● | | 13 | | ns |
| t_{ZL} | Receiver Enable to Output Low | $C_{RL} = 15\text{pF}$ (Figures 2 and 8) S1 Closed | ● | | 20 | 50 | ns |
| t_{ZH} | Receiver Enable to Output High | $C_{RL} = 15\text{pF}$ (Figures 2 and 8) S2 Closed | ● | | 20 | 50 | ns |
| t_{LZ} | Receiver Disable from Low | $C_{RL} = 15\text{pF}$ (Figures 2 and 8) S1 Closed | ● | | 20 | 50 | ns |
| t_{HZ} | Receiver Disable from High | $C_{RL} = 15\text{pF}$ (Figures 2 and 8) S2 Closed | ● | | 20 | 50 | ns |

Note 1: Absolute maximum ratings are those beyond which the safety of the device cannot be guaranteed.

Note 2: All currents into device pins are positive; all currents out of device pins are negative. All voltages are referenced to device ground unless otherwise specified.

Note 3: All typicals are given for $V_{CC} = 5V$ and $T_A = 25^\circ\text{C}$.

Note 4: The LTC485 is guaranteed by design to be functional over a supply voltage range of $5V \pm 10\%$. Data sheet parameters are guaranteed over the tested supply voltage range of $5V \pm 5\%$.

TYPICAL PERFORMANCE CHARACTERISTICS

Receiver Output Low Voltage vs Output Current

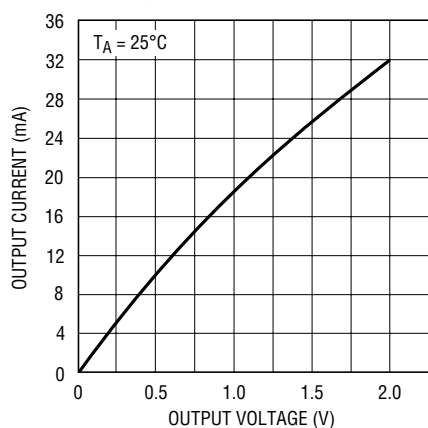

LTC485 • TPC01

Receiver Output High Voltage vs Output Current

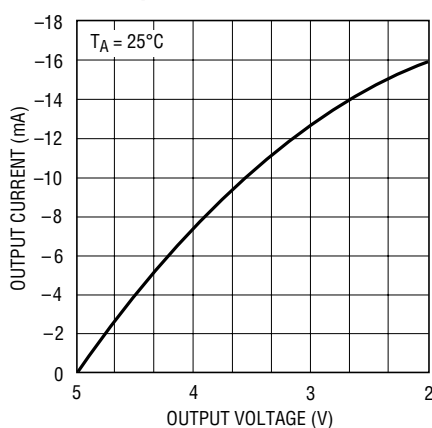

LTC485 • TPC02

Receiver Output High Voltage vs Temperature

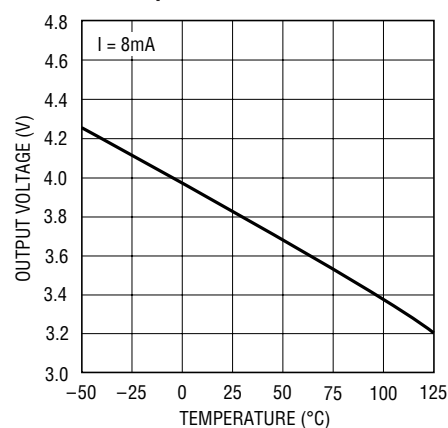

LTC485 • TPC03

sn 485LTC485ffs

TYPICAL PERFORMANCE CHARACTERISTICS

Receiver Output Low Voltage vs Temperature

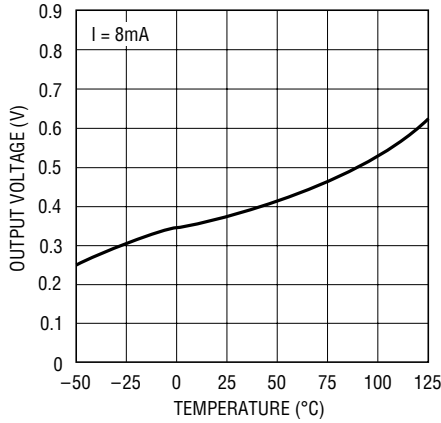

LTC485 • TPC03

Driver Differential Output Voltage vs Output Current

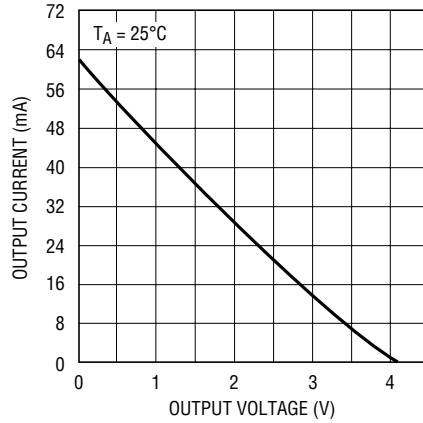

LTC485 • TPC05

Driver Differential Output Voltage vs Temperature

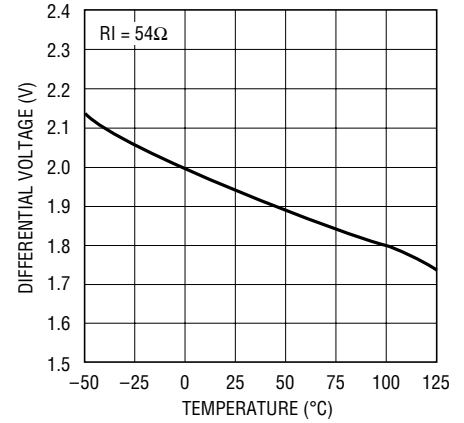

LTC485 • TPC06

Driver Output Low Voltage vs Output Current

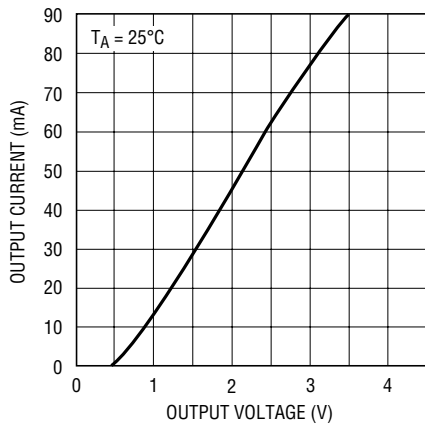

LTC485 • TPC07

Driver Output High Voltage vs Output Current

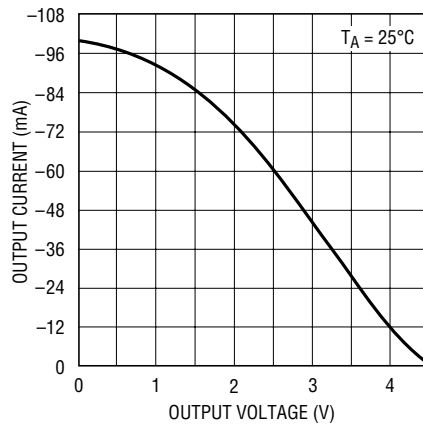

LTC485 • TPC08

TTL Input Threshold vs Temperature

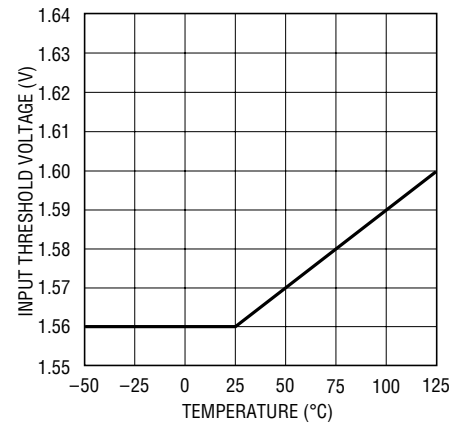

LTC485 • TPC09

Receiver |t_{PLH} - t_{PHL}| vs Temperature

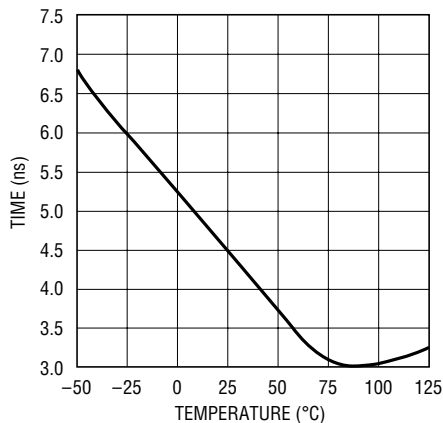

LTC485 • TPC10

Driver Skew vs Temperature

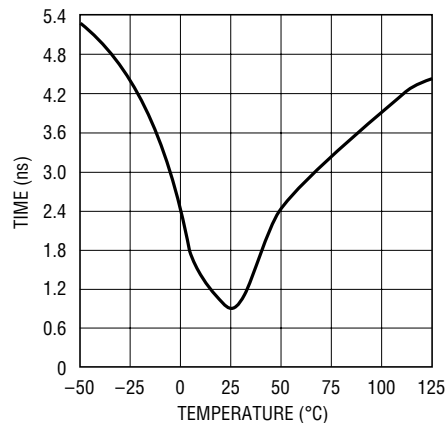

LTC485 • TPC11

Supply Current vs Temperature

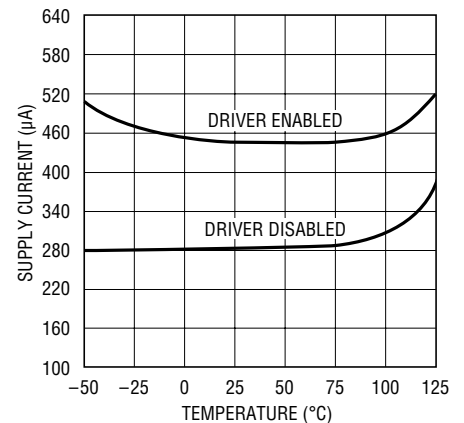

LTC485 • TPC12

PIN FUNCTIONS

RO (Pin 1): Receiver Output. If the receiver output is enabled (\overline{RE} low), then if $A > B$ by 200mV, RO will be high. If $A < B$ by 200mV, then RO will be low.

\overline{RE} (Pin 2): Receiver Output Enable. A low enables the receiver output, RO. A high input forces the receiver output into a high impedance state.

DE (Pin 3): Driver Outputs Enable. A high on DE enables the driver output. A and B, and the chip will function as a line driver. A low input will force the driver outputs into a high impedance state and the chip will function as a line receiver.

DI (Pin 4): Driver Input. If the driver outputs are enabled (DE high), then a low on DI forces the outputs A low and B high. A high on DI with the driver outputs enabled will force A high and B low.

GND (Pin 5): Ground Connection.

A (Pin 6): Driver Output/Receiver Input.

B (Pin 7): Driver Output/Receiver Input.

V_{CC} (Pin 8): Positive Supply; $4.75 < V_{CC} < 5.25$.

TEST CIRCUITS

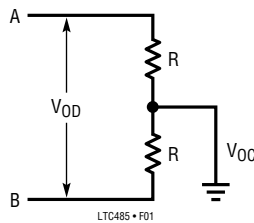

Figure 1. Driver DC Test Load

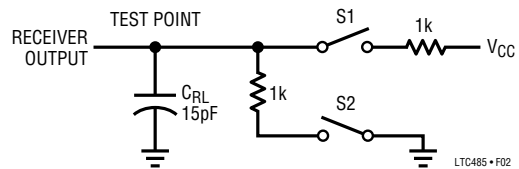

Figure 2. Receiver Timing Test Load

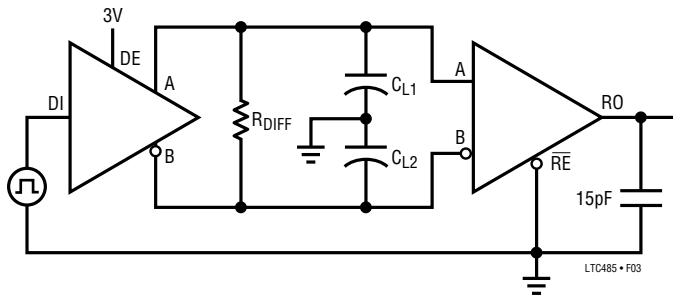

Figure 3. Driver/Receiver Timing Test Circuit

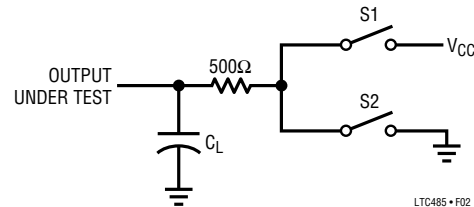

Figure 4. Driver Timing Test Load #2

SWITCHING TIME WAVEFORMS

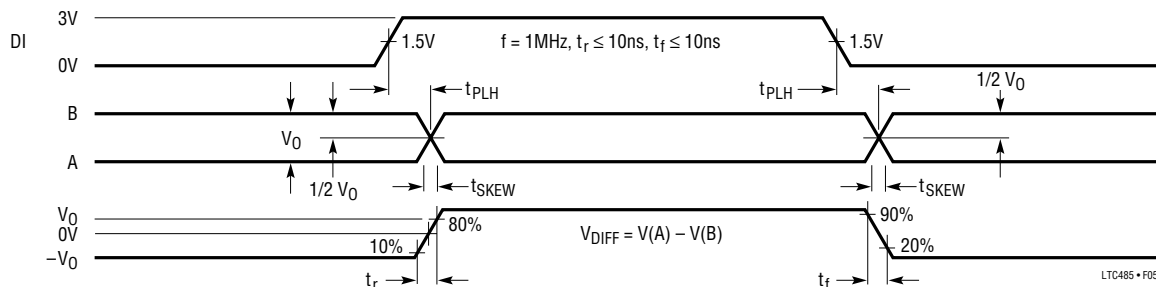

Figure 5. Driver Propagation Delays

SWITCHING TIME WAVEFORMS

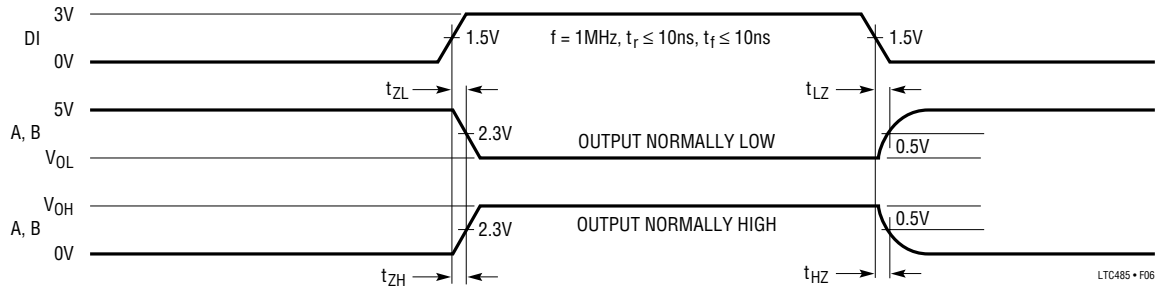

Figure 6. Driver Enable and Disable Times

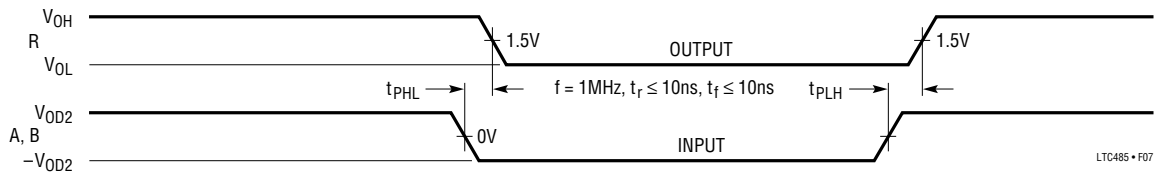

Figure 7. Receiver Propagation Delays

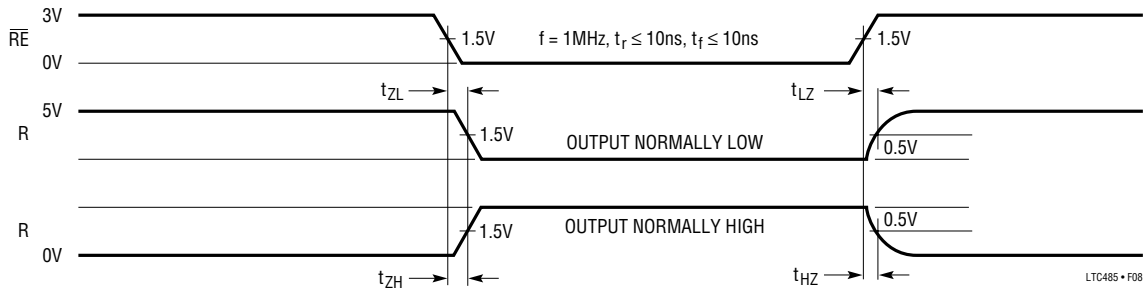

Figure 8. Receiver Enable and Disable Times

FUNCTION TABLES

LTC485 Transmitting

| INPUTS | | | LINE CONDITION | OUTPUTS | |
|--------|----|----|----------------|---------|---|
| RE | DE | DI | | B | A |
| X | 1 | 1 | No Fault | 0 | 1 |
| X | 1 | 0 | No Fault | 1 | 0 |
| X | 0 | X | X | Z | Z |
| X | 1 | X | Fault | Z | Z |

LTC485 Receiving

| INPUTS | | | OUTPUTS |
|--------|----|--------------|---------|
| RE | DE | A - B | R |
| 0 | 0 | $\geq 0.2V$ | 1 |
| 0 | 0 | $\leq -0.2V$ | 0 |
| 0 | 0 | Inputs Open | 1 |
| 1 | 0 | X | Z |

sn485 LTC485ffs

APPLICATIONS INFORMATION

Basic Theory of Operation

Previous RS485 transceivers have been designed using bipolar technology because the common-mode range of the device must extend beyond the supplies and the device must be immune to ESD damage and latchup. Unfortunately, the bipolar devices draw a large amount of supply current, which is unacceptable for the numerous applications that require low power consumption. The LTC485 is the first CMOS RS485/RS422 transceiver which features ultra-low power consumption without sacrificing ESD and latchup immunity.

The LTC485 uses a proprietary driver output stage, which allows a common-mode range that extends beyond the power supplies while virtually eliminating latchup and providing excellent ESD protection. Figure 9 shows the LTC485 output stage while Figure 10 shows a conventional CMOS output stage.

When the conventional CMOS output stage of Figure 10 enters a high impedance state, both the P-channel (P1) and the N-channel (N1) are turned off. If the output is then driven above V_{CC} or below ground, the P + /N-well diode

(D1) or the N + /P-substrate diode (D2) respectively will turn on and clamp the output to the supply. Thus, the output stage is no longer in a high impedance state and is not able to meet the RS485 common-mode range requirement. In addition, the large amount of current flowing through either diode will induce the well known CMOS latchup condition, which could destroy the device.

The LTC485 output stage of Figure 9 eliminates these problems by adding two Schottky diodes, SD3 and SD4. The Schottky diodes are fabricated by a proprietary modification to the standard N-well CMOS process. When the output stage is operating normally, the Schottky diodes are forward biased and have a small voltage drop across them. When the output is in the high impedance state and is driven above V_{CC} or below ground, the parasitic diodes D1 or D2 still turn on, but SD3 or SD4 will reverse bias and prevent current from flowing into the N-well or the substrate. Thus, the high impedance state is maintained even with the output voltage beyond the supplies. With no minority carrier current flowing into the N-well or substrate, latchup is virtually eliminated under power-up or power-down conditions.

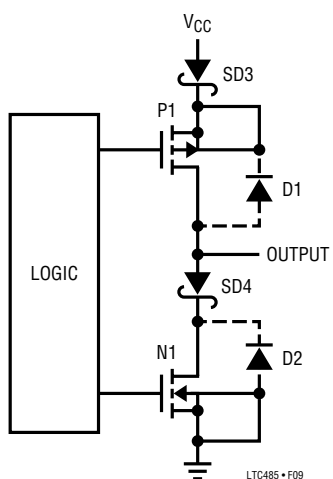

Figure 9. LTC485 Output Stage

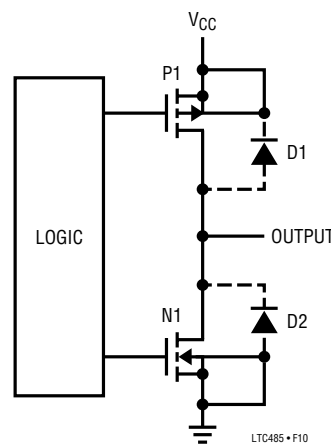

Figure 10. Conventional CMOS Output Stage

APPLICATIONS INFORMATION

The LTC485 output stage will maintain a high impedance state until the breakdown of the N-channel or P-channel is reached when going positive or negative respectively. The output will be clamped to either V_{CC} or ground by a Zener voltage plus a Schottky diode drop, but this voltage is way beyond the RS485 operating range. This clamp protects the MOS gates from ESD voltages well over 2000V. Because the ESD injected current in the N-well or substrate consists of majority carriers, latchup is prevented by careful layout techniques.

Propagation Delay

Many digital encoding schemes are dependent upon the difference in the propagation delay times of the driver and the receiver. Using the test circuit of Figure 13, Figures 11 and 12 show the typical LTC485 receiver propagation delay.

The receiver delay times are:

$$|t_{PLH} - t_{PHL}| = 9\text{ns Typ, } V_{CC} = 5\text{V}$$

The driver skew times are:

$$\text{Skew} = 5\text{ns Typ, } V_{CC} = 5\text{V}$$

$$10\text{ns Max, } V_{CC} = 5\text{V, } T_A = -40^\circ\text{C to } 85^\circ\text{C}$$

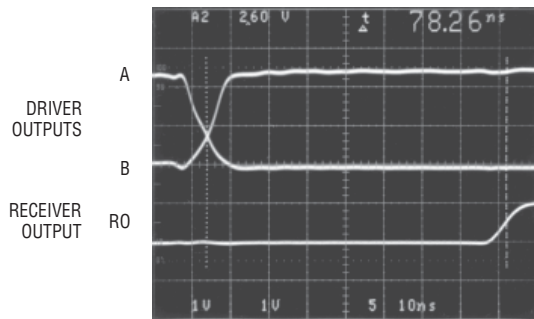

Figure 11. Receiver t_{PHL}

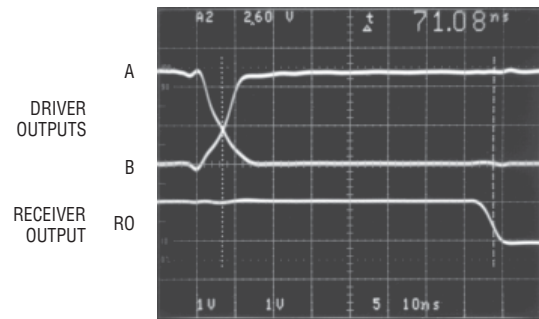

Figure 12. Receiver t_{PLH}

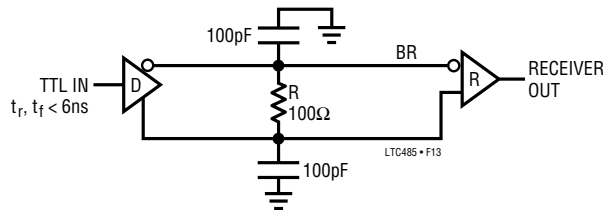

Figure 13. Receiver Propagation Delay Test Circuit

APPLICATIONS INFORMATION

LTC485 Line Length vs Data Rate

The maximum line length allowable for the RS422/RS485 standard is 4000 feet.

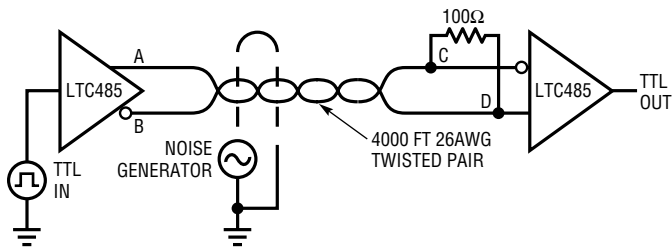

Figure 14. Line Length Test Circuit

Using the test circuit in Figure 14, Figures 15 and 16 show that with $\sim 20V_{P-P}$ common mode noise injected on the line, The LTC485 is able to reconstruct the data stream at the end of 4000 feet of twisted pair wire.

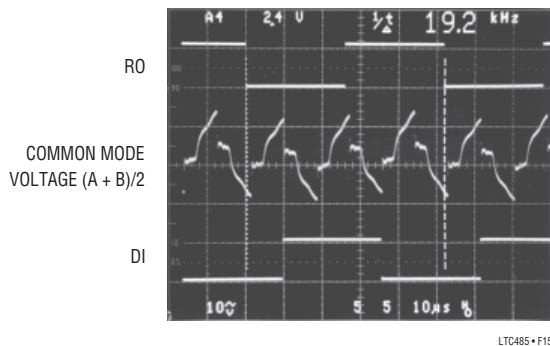

Figure 15. System Common Mode Voltage at 19.2kHz

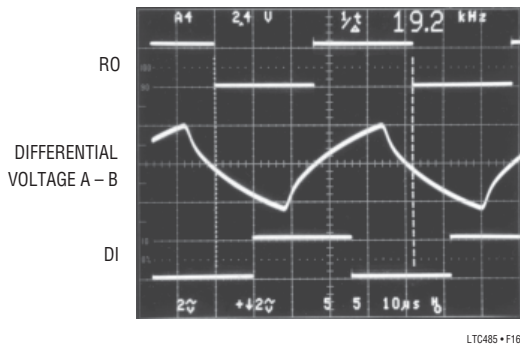

Figure 16. System Differential Voltage at 19.2kHz

Figures 17 and 18 show that the LTC485 is able to comfortably drive 4000 feet of wire at 110kHz.

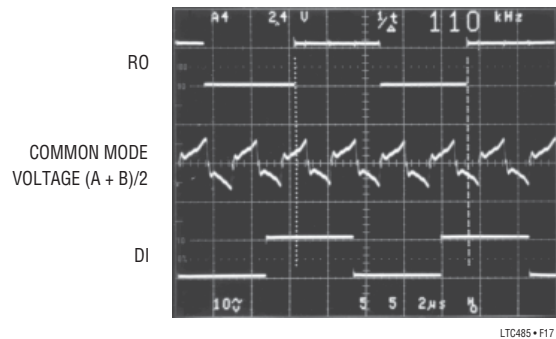

Figure 17. System Common Mode Voltage at 110kHz

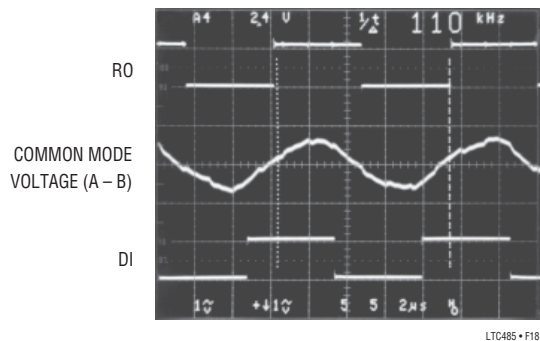

Figure 18. System Differential Voltage at 110kHz

When specifying line length vs maximum data rate the curve in Figure 19 should be used:

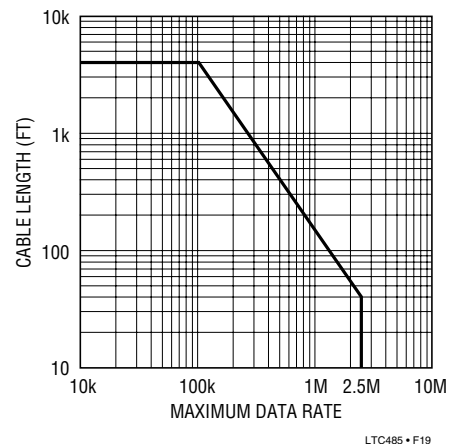
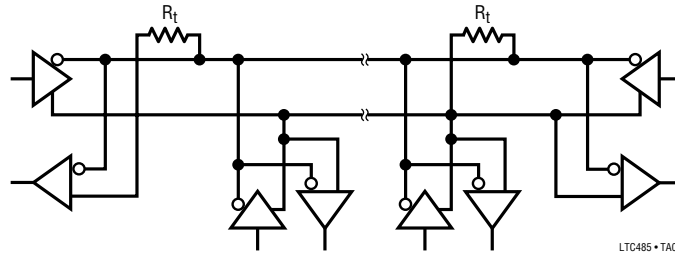

Figure 19. Cable Length vs Maximum Data Rate

TYPICAL APPLICATIONS

Typical RS485 Network



PACKAGE DESCRIPTION

J8 Package
8-Lead CERDIP (Narrow .300 Inch, Hermetic)
 (Reference LTC DWG # 05-08-1110)

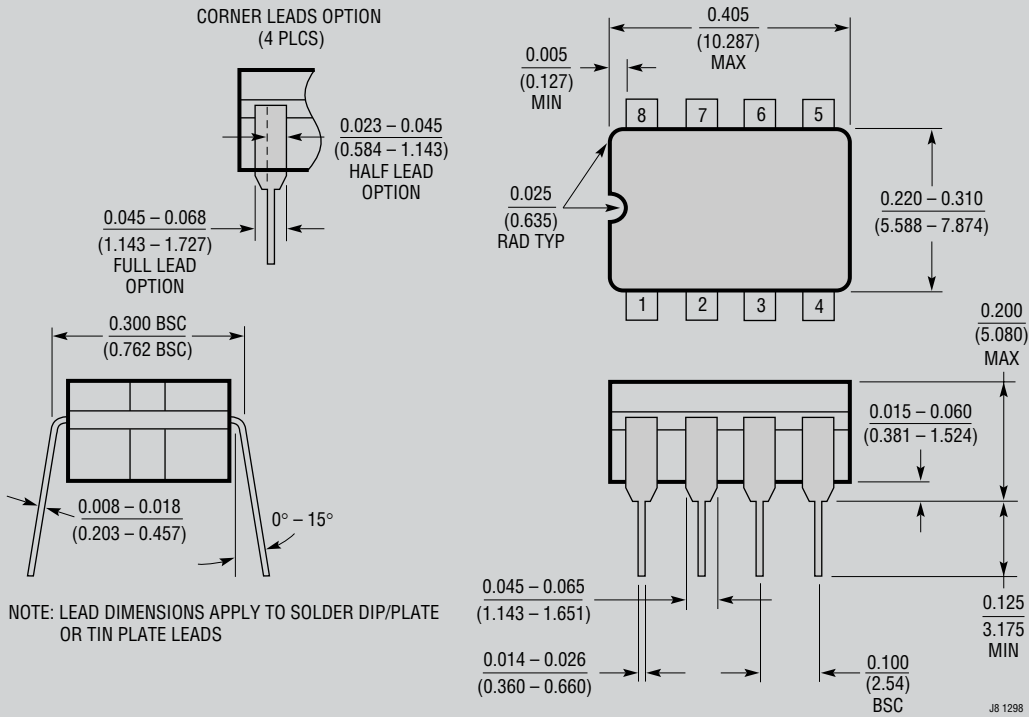

OBSOLETE PACKAGE

PACKAGE DESCRIPTION

N8 Package 8-Lead PDIP (Narrow .300 Inch) (Reference LTC DWG # 05-08-1510)

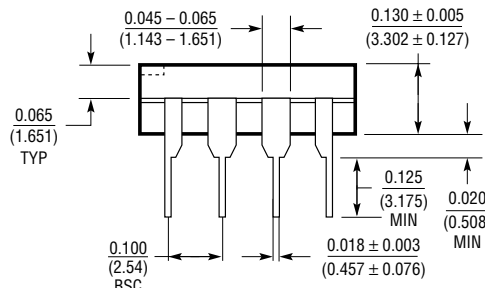
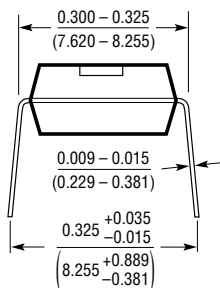
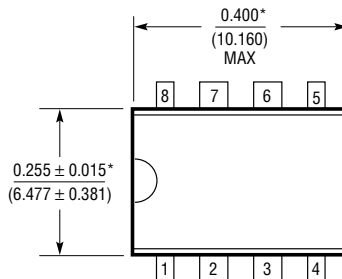

*THESE DIMENSIONS DO NOT INCLUDE MOLD FLASH OR PROTRUSIONS.
MOLD FLASH OR PROTRUSIONS SHALL NOT EXCEED 0.010 INCH (0.254mm)

N8 1098

S8 Package 8-Lead Plastic Small Outline (Narrow .150 Inch) (Reference LTC DWG # 05-08-1610)

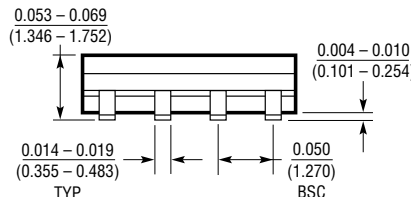
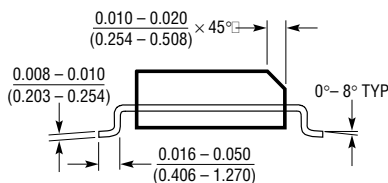
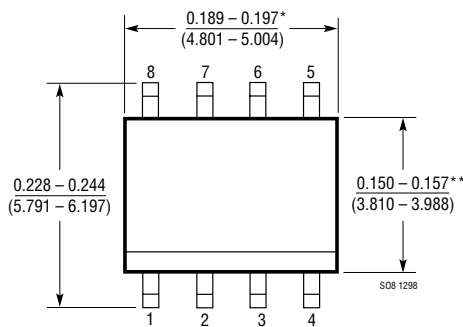

*DIMENSION DOES NOT INCLUDE MOLD FLASH. MOLD FLASH SHALL NOT EXCEED 0.006" (0.152mm) PER SIDE

**DIMENSION DOES NOT INCLUDE INTERLEAD FLASH. INTERLEAD FLASH SHALL NOT EXCEED 0.010" (0.254mm) PER SIDE

sn 485LTC485ffs

LTC485

RELATED PARTS

| PART NUMBER | DESCRIPTION | COMMENTS |
|-----------------|--|--|
| LTC486/LTC487 | Low Power Quad RS485 Drivers | 110 μ A Supply Current |
| LTC488/LTC489 | Low Power Quad RS485 Receivers | 7mA Supply Current |
| LTC490/LTC491 | Low Power Full-Duplex RS485 Transceivers | 300 μ A Supply Current |
| LTC1480 | 3.3V Supply RS485 Transceiver | Lower Supply Voltage |
| LTC1481 | Low Power RS485 Transceiver with Shutdown | Lowest Power |
| LTC1482 | RS485 Transceiver with Carrier Detect | \pm 15kV ESD, Fail-Safe |
| LTC1483 | Low Power, Low EMI RS485 Transceiver | Slew Rate Limited Driver Outputs, Lowest Power |
| LTC1484 | RS485 Transceiver with Fail-Safe | \pm 15kV ESD, MSOP Package |
| LTC1485 | 10Mbps RS485 Transceiver | High Speed |
| LTC1518/LTC1519 | 52Mbps Quad RS485 Receivers | Higher Speed, LTC488/LTC489 Pin-Compatible |
| LTC1520 | LVDS-Compatible Quad Receiver | 100mV Threshold, Low Channel-to-Channel Skew |
| LTC1535 | 2500V Isolated RS485 Transceiver | Full-Duplex, Self-Powered Using External Transformer |
| LTC1685 | 52Mbps RS485 Transceiver | Industry-Standard Pinout, 500ps Propagation Delay Skew |
| LTC1686/LTC1687 | 52Mbps Full-Duplex RS485 Transceiver | LTC490/LTC491 Pin Compatible |
| LTC1688/LTC1689 | 100Mbps Quad RS485 Drivers | Highest Speed, LTC486/LTC487 Pin Compatible |
| LTC1690 | Full-Duplex RS485 Transceiver with Fail-Safe | \pm 15kV ESD, LTC490 Pin Compatible |
| LT1785/LTC1785A | \pm 60V Protected RS485 Transceivers | \pm 15kV ESD, Fail-Safe (LT1785A) |
| LT1791/LTC1791A | \pm 60V Protected Full-Duplex RS485 Transceivers | \pm 15kV ESD, Fail-Safe (LT1791A) |