

# ECG<sup>®</sup>

## User Manual

---

Wireless Inspection Camera  
with Color LCD Monitor

Model No.: WIC-1

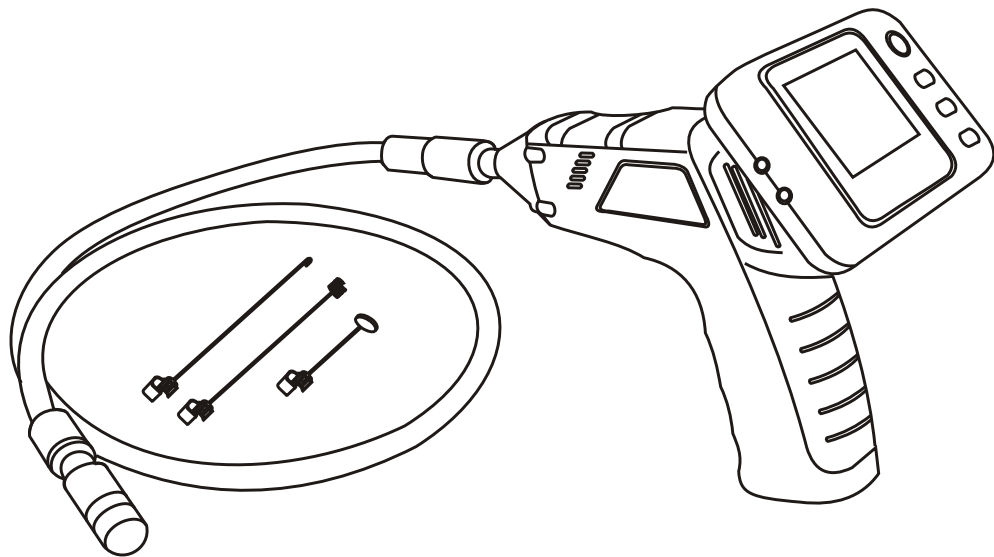

---

Please read this user manual carefully before using this product.

---

# CONTENTS

INTRODUCTION ..... 1

PARTS LIST ..... 1

FEATURES ..... 2

INSTALLATION ..... 3

MONITOR CHARGING & VIDEO OUT..... 5

GENERAL SAFETY INFORMATION ..... 6

OPERATION ..... 6

SPECIFICATIONS ..... 8

WARNINGS ..... 9

WARRANTY ..... 9

# **INTRODUCTION**

Thank you for purchasing our Wireless Inspection Camera with color LCD monitor! Please read this manual carefully before using this product.

This product is designed as an inspection device. It can be used to look into tight spots and display real-time video to its wireless color monitor. Typical applications include HVAC inspection, automotive inspection, cable routing, electrical, general contracting, home theater installation, plumbing inspection, and much, much, more!

## **PARTS LIST**

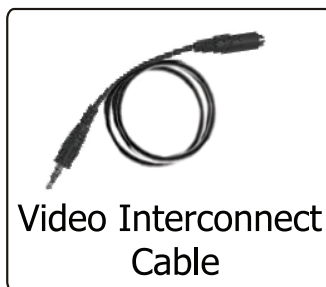
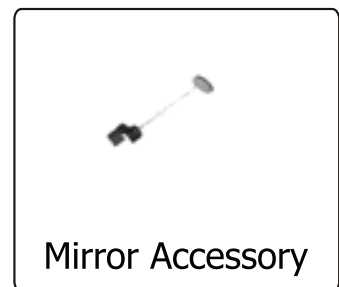
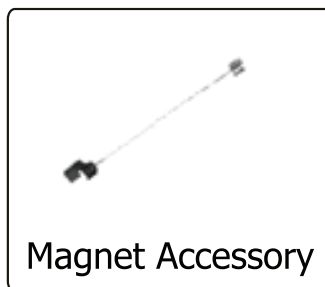
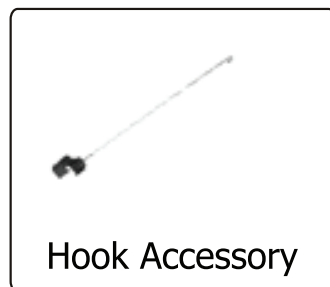

\* Please visit [www.nteinc.com](http://www.nteinc.com) for a full list of all accessories.

# FEATURES

## Camera, Shaft, & Base Unit

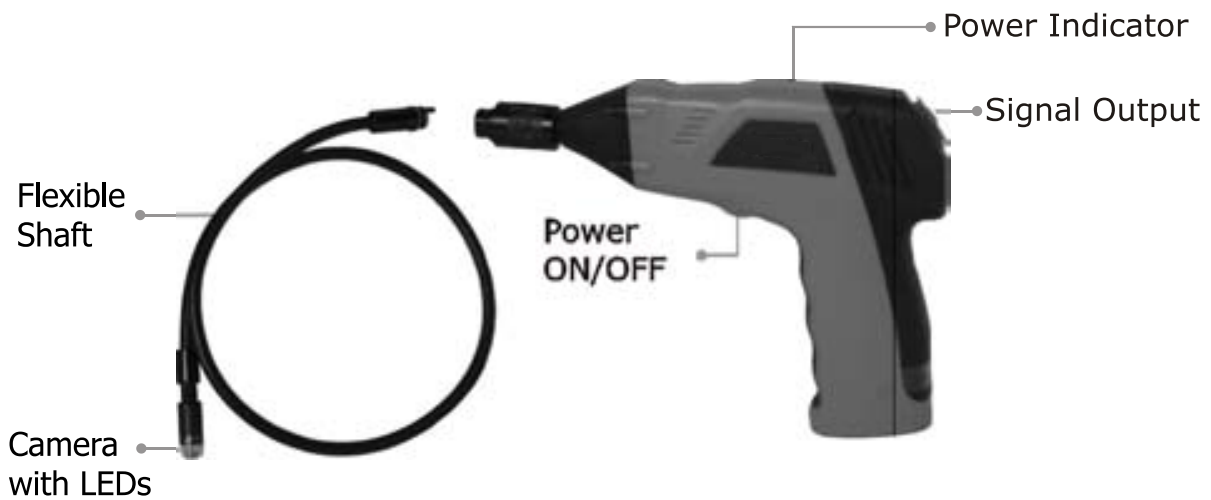

## LCD Monitor

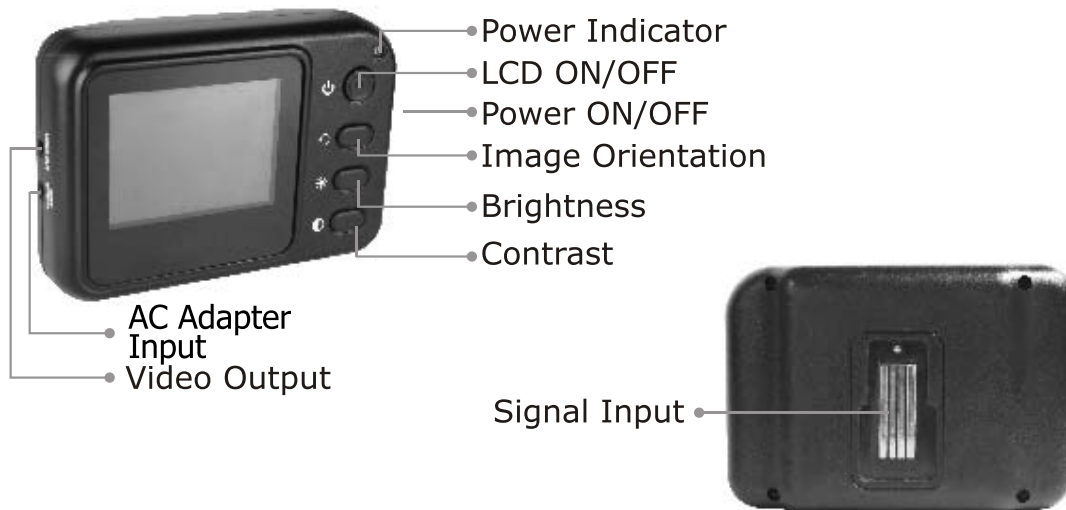

# INSTALLATION

Please install the batteries in the base unit before using this product.

## **To Install Batteries:**

1. Using a screwdriver, remove the screw and battery cover.

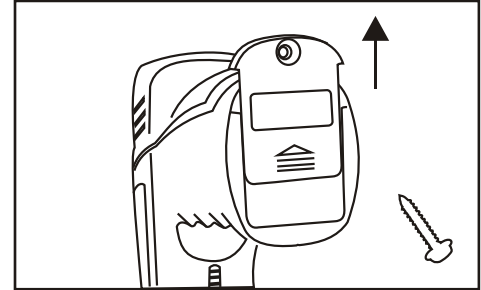
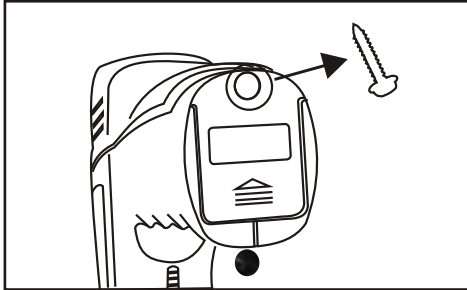

2. Remove the battery compartment and insert four new AA batteries into the proper slots in the battery compartment. Proper battery orientation is indicated on the battery compartment.

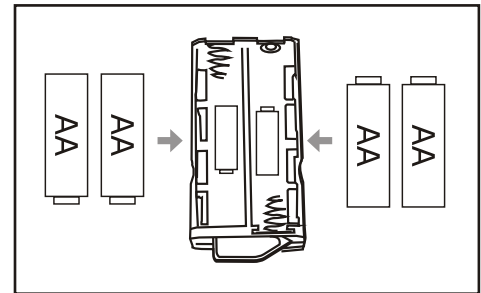
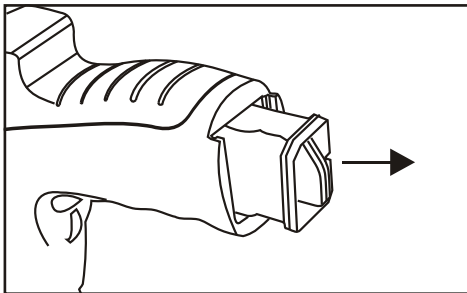

3. Reinstall the battery compartment, battery cover, and screw.

**NOTE!** Make sure your hands are dry before installation or replacement of batteries.

## **To Install The Camera With Flexible Shaft**

Connect the camera shaft to the base unit, making sure the keyed ends are properly aligned. Once they are aligned, finger tighten the knurled knob to secure the connection.

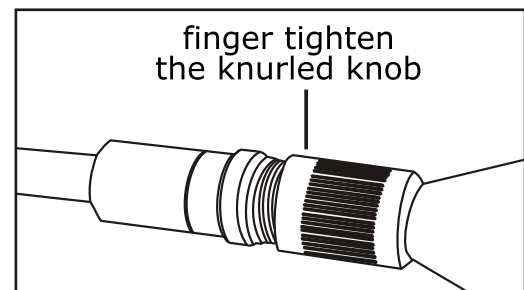
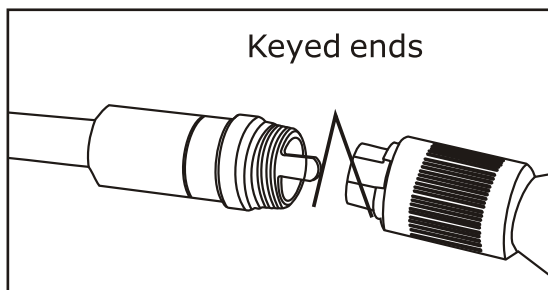

**CAUTION!** Make sure to only tighten and un-tighten the knurled knob and not the shaft.

## Installing LCD Monitor:

The product also supports wired use by connecting the monitor to the base unit.

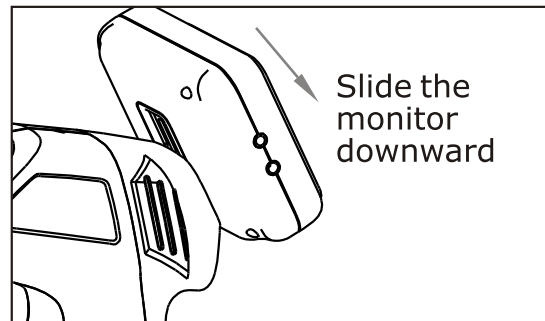
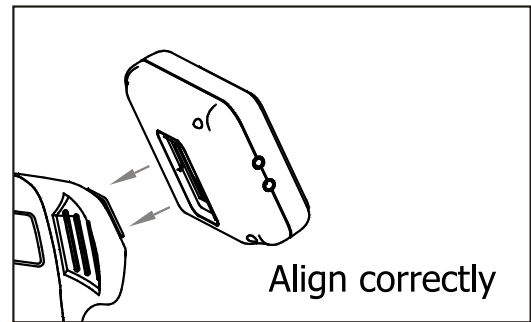
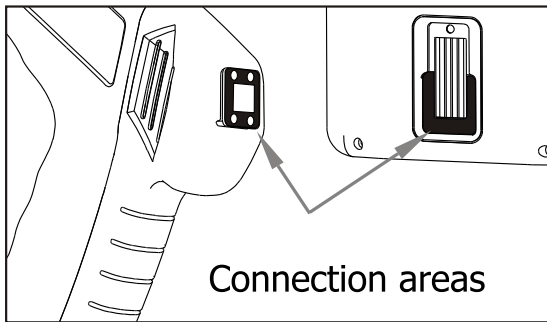

## Installing Accessories:

The three included accessories, (mirror, hook, and magnet), all attach to the shaft head the same way.

To connect, hold the shaft head and slip the end of the accessory over the flat area as shown below.

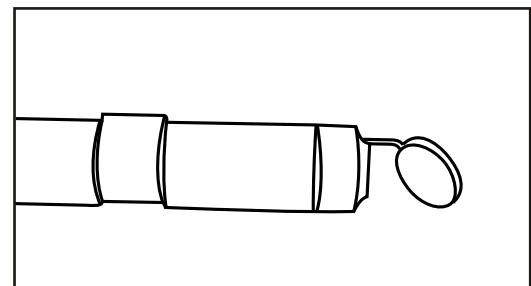
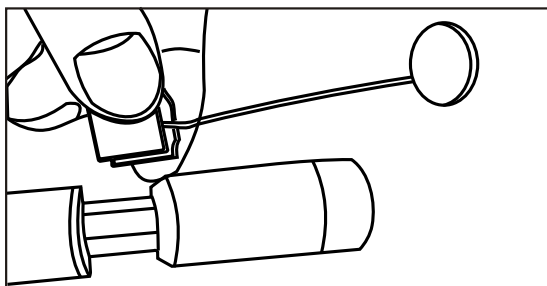

## **MONITOR CHARGING**

Connect the adapter connector to the AC adapter. Insert the adapter connector into the monitor area labeled DC8V. Plug the AC adapter into an AC outlet. The power indicator LED will light red indicating the unit is being charged.

The built-in Lithium-ion battery will begin charging after the AC adapter is plugged in, with the red indicator on during charging and off after a full charge.

**NOTE!** An average (full) charge time will take approximately 5 hours.

**NOTE!** A full charge can power the monitor for about 5 hours continuously.

**NOTE!** When charging, the monitor will be available for use.

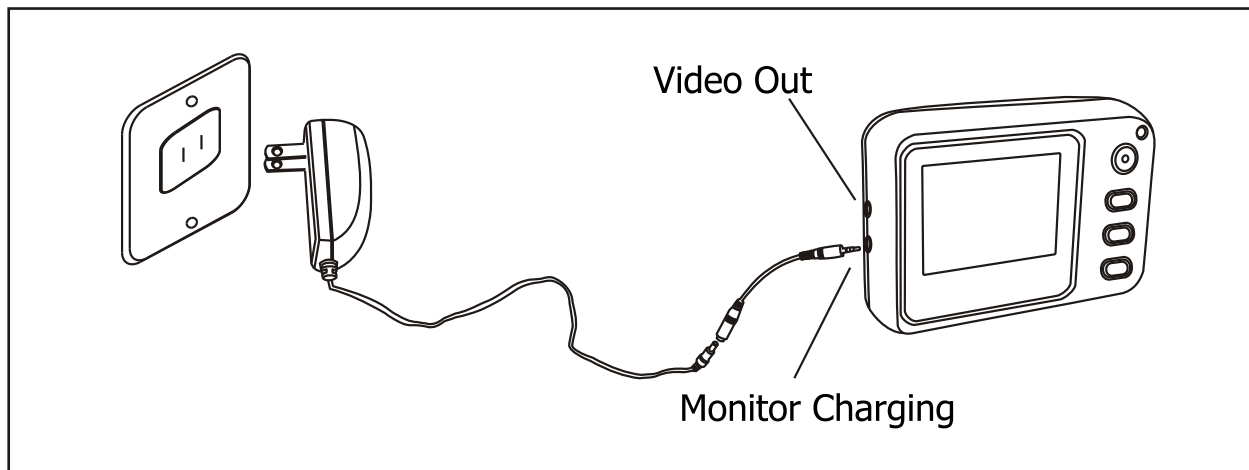

## **VIDEO OUT**

Insert the video interconnect cable into the monitor area labeled VIDEO OUT.

Insert the other end of the cable into the VIDEO IN jack of a TV or another monitor. The LCD Monitor will output a high quality video which can be recorded!

**NOTE!** The monitor must be in wireless mode in order to enable the Video Out function.

**NOTE!** Video Out feature requires TV to be in line or video input mode.

**NOTE!** Video Out feature may output a black and white signal.

# GENERAL SAFETY INFORMATION

Please read and understand all of the following instructions. Failure to follow all of the instructions listed below may result in electric shock, fire, and/or serious personal injury.

---

## CAUTION!

---

- ※ **Prevent liquid entry.** Never spill liquid of any kind on the monitor. Liquid increases the risk of electrical shock and damage to the product.
- ※ **The unit is not shock-resistant.** Do not drop it.
- ※ **Do not immerse the monitor in water.** Store in a dry place. Such measures reduce the risk of electric shock and damage. The camera and the shaft are waterproof when the unit is fully assembled, but the monitor and base unit are not.
- ※ **Do not use the camera if condensation forms inside the lens.** Let the water evaporate before using again.

## Operation

1. Roll the ON/OFF switch to turn on the camera, and the power indicator will light. The switch then acts as a dimmer for the two super bright LEDs that surround the camera and provide high quality lighting.

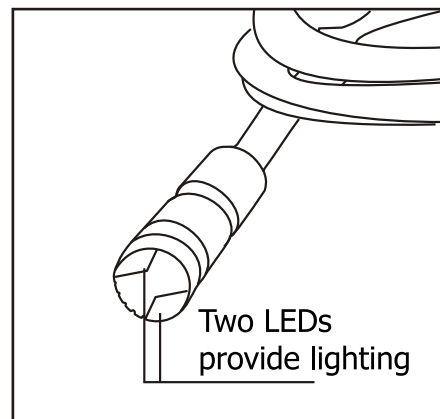
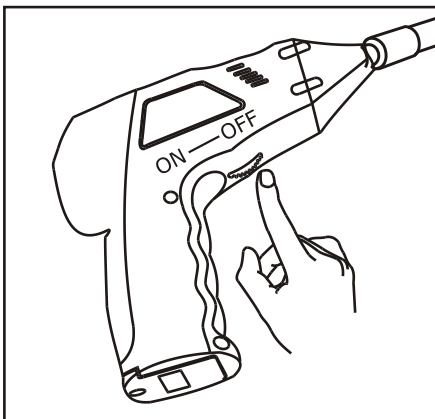



2. Turn the power ON/OFF switch on the monitor to the ON position and the power indicator will flash green. Press the LCD ON/OFF button to turn on the display. Adjust brightness, contrast, and image orientation of the camera for better image effect.

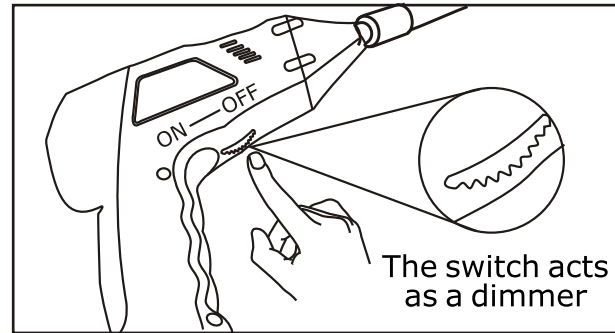
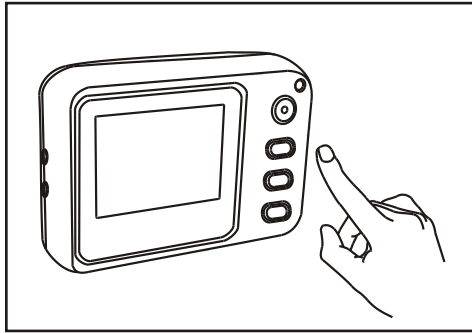

3. When in use, the shaft will easily maneuver itself into any position.



wireless

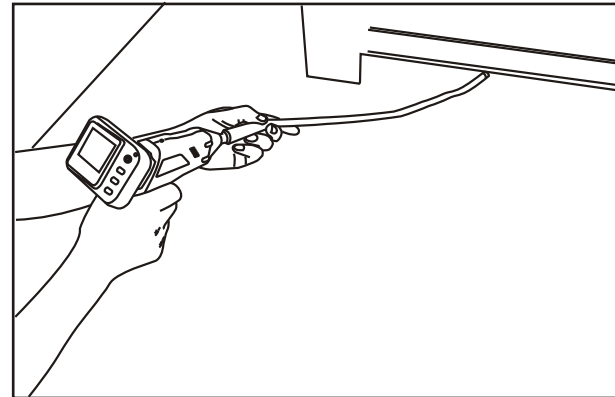

wired

**TIP!** The flexible shaft can be bent into many shapes. This helps you to explore into very small areas.

4. The included, handy accessories of our Wireless Inspection Camera can be used to retrieve small items like dropped rings or screws.

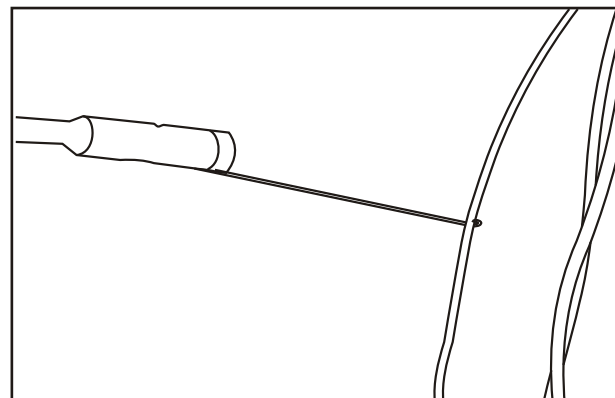

# SPECIFICATIONS

|         |                            |                                |
|---------|----------------------------|--------------------------------|
| CAMERA  | Imaging Sensor             | CMOS                           |
|         | Total Pixels               | 712×486                        |
|         | Horizontal View Angle      | 50°                            |
|         | Transmission Frequency     | 2468MHz                        |
|         | Modulation Type            | FM                             |
|         | Bandwidth                  | 18MHz                          |
|         | Power Supply               | 4 x AA batteries               |
|         | Weight (with shaft)        | 1.17lbs.                       |
| MONITOR | Screen Type                | 2.36" LCD                      |
|         | Effective Pixels           | 480 × 240                      |
|         | Video System               | NTSC                           |
|         | Transmission Frequency     | 2468MHz                        |
|         | Exterior Supply Voltage    | 8V-36VDC                       |
|         | Consumption Current (Max.) | 450mA                          |
|         | Video Output Level         | 0.9-1.3V <sub>p-p</sub> @75ohm |
|         | Dimensions(W×D×H) (inches) | 3.94 x 2.76 x 1.18             |
|         | Weight                     | 0.31lbs.                       |
|         | Operating Temperature      | 14°F~122°F                     |
|         | Operating Humidity(Max.)   | 15~85%RH                       |

- \* Actual transmission range may vary according to the weather, location, and building interference.
- \* All specifications are subject to change without prior notice.

## WARNINGS

- The monitor shall not be exposed to dripping or splashing liquid. No objects filled with liquids shall be placed on the unit.
- Turn off the Camera/Monitor when the system is not in use.
- The AC adapter is used only for charging the monitor.
- Do not cut the DC power cable of the AC adapter to fit with any other power source.
- Attention should be drawn to the environmental aspects of battery disposal.
- Remove the batteries when cleaning the unit.
- Remove the batteries before storing the unit for an extended period of time.
- When necessary, replace all four batteries in this unit with new ones.
- Use only the size and type of batteries specified.
- Be sure to install the batteries with the correct polarity as indicated in the battery compartment.

## WARRANTY

**1 Year Warranty:** This product is warranted to be free from defects in materials and workmanship and meet applicable specifications when tested to ratings. This warranty is in lieu of any other warranty expressed, implied, or statutory. NTE's liability under this warranty is limited to repairing, replacing, or issuing credit (at the discretion of NTE) for such products that become defective or fail to meet specification during the warranty period of one year from the date of sale. The technical data shown is intended to provide safe areas of operation for this product. Determination as to whether a product is actually defective rests with NTE. In no event will NTE be liable for consequential or special damages.

The graphics included in this manual are subject to change without notice.

# FCC INFORMATION

This device complies with part 15 of FCC Rules. Operation is subject to the following two conditions:

- (1) This device may not cause harmful interference.
- (2) This device must accept any interference received, including interference that may cause undesired operation.

Changes or modifications not expressly approved by the party responsible for compliance could void the users authority to operate the equipment.

## Environmental Protection

Electrical waste products should not be disposed of with household waste. Please recycle where facilities exist. Check with your Local Authority or retailer for recycling advice.



*NTE Electronics, Inc.*  
44 Farrand Street  
Bloomfield, NJ 07003  
Phone: 973-748-5089  
Fax: 973-748-6224  
[www.nteinc.com](http://www.nteinc.com)

**ECG**<sup>®</sup> is a registered trademark of **NTE**<sup>®</sup>  
ELECTRONICS, INC.