

RP-RM83F-.. Heavy-Duty Rope Pulls

With E-Stop Button, for Indoor or Outdoor Use

Original Instructions



- Contacts latch open when rope is pulled or in case of a broken wire; requires manual reset
- Aluminum die-cast housing, rated IP67 and NEMA 4, suitable for demanding indoor and outdoor industrial environments
- Innovative **RP-RM83F-..LT..** design for quick, easy rope adjustment
- Rope spans up to 75 m (245'), depending on model
- Both Safety contacts are closed with normal rope tension, and open when the rope is pulled, if it breaks, or if tension is reduced
- Both Monitoring contacts operate opposite the safety contacts, for monitoring by another device
- Additional Aux. 24V solid-state PNP output on some models provides remote rope tension monitoring
- Tension indicator window indicates proper rope tension for operation or safety contacts latched open (the rope pull or the E-stop button is actuated)

Models

Model	Max. Rope Length	Rope Connection	Aux. Status Output	Run Position	Cable Pulled/ Cable Break	Switching Diagram	
RP-RM83F-75LTE	75 m (245')	Built-in Turnbuckle	Yes	Cable Run Position (All Models)		No PNP Aux. Output Models	
RP-RM83F-75LRE		Ring		S1	S2		
RP-RM83F-75LT		Built-in Turnbuckle	No				
RP-RM83F-75LR		Ring					
RP-RM83F-38LTE	37.5 m (123')	Built-in Turnbuckle	Yes	Cable Pulled / Cable Break Position (All Models)			PNP Aux. Output Models
RP-RM83F-38LRE		Ring		S1	S2		
RP-RM83F-38LT		Built-in Turnbuckle	No				
RP-RM83F-38LR		Ring					

NOTE: This symbol \ominus for a positive-opening safety contact (IEC 60947-5-1) is used in the switching diagram to identify the point in actuator travel where the normally-closed safety contact is fully open.

Open Closed



Important Information . . .

. . . Regarding the Use of Rope Pull Emergency Stop Switches

In the United States, the functions that Banner rope pull emergency stop switches are intended to perform are regulated by the Occupational Safety and Health Administration (OSHA). Whether or not any particular rope pull switch installation meets all applicable OSHA requirements depends upon factors that are beyond the control of Banner Engineering Corp. These factors include the details of how the switches are applied, installed, wired, operated, and maintained.

Banner Engineering Corp. has attempted to provide complete application, installation, operation, and maintenance instructions in this document. Direct any questions regarding the use or installation of rope pull switches to the factory applications department at the numbers or address listed on the last page.

Banner Engineering Corp. recommends that rope pull emergency stop switches be applied according to the guidelines set forth in the standards listed below. In addition, the user has the responsibility to ensure that all local, state, and national laws, rules, codes, and regulations relating to the use of Banner rope pull switches in each application are satisfied. Extreme care is urged that all legal requirements are met and that all installation and maintenance instructions are followed.

U. S. Standards Applicable to Use of Emergency Stop Safety Modules

ANSI B11 Standards for Machine Tools “Safety Requirements for the Construction, Care and Use” Available from: Safety Director AMT—The Association for Manufacturing Technology 7901 Westpark Drive McLean, VA 22102 Tel.: 703-893-2900

NFPA79 “Electrical Standard for Industrial Machinery (1997)”

Available from: National Fire Protection Association 1 Batterymarch Park, P.O. Box 9101 Quincy, MA 02269-9101 Tel.: 800-344-3555

ANSI/RIA R15.06 “Safety Requirements for Industrial Robots and Robot Systems”

Available from: Robotic Industries Association 900 Victors Way, P.O. Box 3724 Ann Arbor, MI 48106 Tel.: 734-994-6088

European Standards Applicable to Use of Emergency Stop Safety Modules

ISO/TR12100-1&-2 “Safety of Machinery—Basic Concepts, General Principles for Design (EN 292-1 & -2) Part 1: Basic Terminology, Methodology”; Part 2: Technical Principles and Specifications

ISO13849-1 (EN 954-1) “Safety of Machines—Safety Related Parts of Control Systems”

IEC/EN 60204-1 “Electrical Equipment of Machines: Part 1: General Requirements” Also, request a type “C” standard for your specific machinery.

ISO13850 (EN 418) “Safety of Machinery—Emergency Stop Equipment Functional Aspects, Principles for Design”

IEC 60947-5-5 “Electrical Emergency Stop Devices with Mechanical Latching Function”

Available from: Global Engineering Documents 15 Inverness Way East Englewood, CO 80112-5704 Tel.: 800-854-7179

Certificate of Adequacy: This document (p/n 141245, revision A) satisfies the requirements of Machinery Directive 2006/42/EC, Section 1.7.4 — instructions.

Overview

Models **RP-RM83F-..** are rope pull emergency stop switches in compact, heavy-duty die-cast aluminum housings, for indoor or outdoor use. When used with steel wire rope, they can provide emergency stop actuation along conveyors and similar machinery. Red PVC-covered 2, 3, 4, or 5 mm diameter wire rope is recommended, depending on model (force) and rope distance (see Accessories).

The switches have redundant contacts; terminals 11/12 are positive opening when there is a cable-pull or cable-brake situation. When used separately, these contacts provide inputs to a dual-channel safety module. Terminals 11/12 can also be used individually to provide single-channel switching or as a single-channel input to a safety module. Terminals 23/24 are for monitoring purposes only (closed in a cable-break/cable-pull situation).

When the rope is properly tensioned (228 or 133N, depending on model), the red arrows are centered under the hash mark on the tension indicator window, the contacts at terminals 11/12 are closed, and the contacts at terminals 23/24 are open. All models feature "latching" operation. When the rope is pulled, the switch contacts 11/12 open and remain open until the built-in E-stop/reset button is manually reset.

These rope pull emergency stop switches are not generally considered safeguarding devices, in that they do not prevent or reduce exposure of individuals to a hazard. They provide the same function as other types of emergency stop switches.

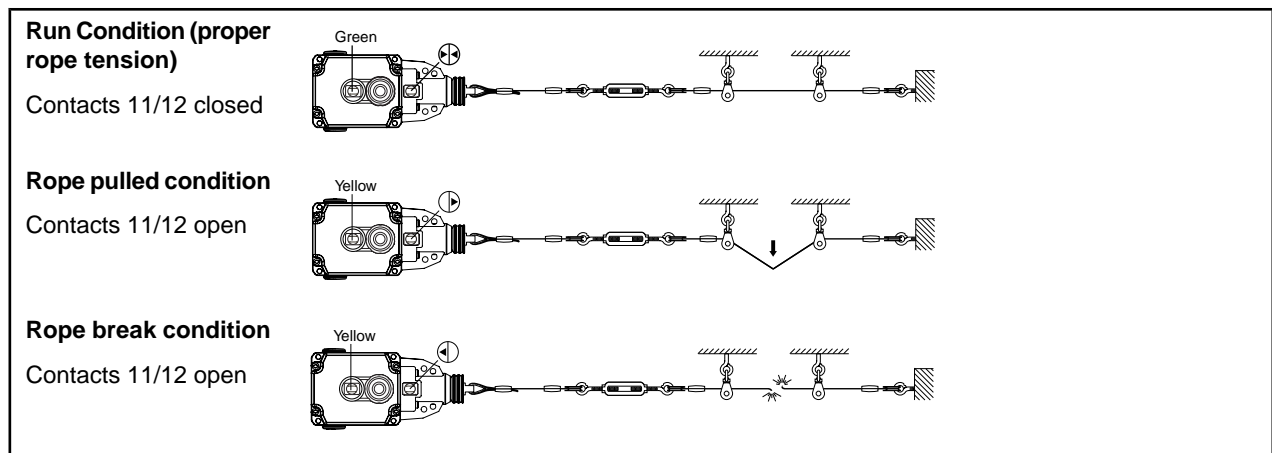

Figure 1: Run, rope pulled, and rope break switch positions



WARNING ... Not a Safeguarding Device

An Emergency Stop Device, including, but not limited to buttons, rope pulls and cable pulls, is not generally considered a safeguard; and does not alone fulfill U.S. or International requirements for safeguarding hazards associated with machinery. The definition of safeguarding is the "protective measure using safeguards [guards or protective devices] to protect persons from the hazards which cannot reasonably be eliminated..." (ISO12100-1, 3.29 and 3.30).

A safeguard limits or eliminates an individual's exposure to a hazard (examples include interlocking devices, safety mats, safety light screens). An emergency stop is considered to be a complementary protective measure, which is neither an inherently safe design measure, nor safeguarding, but may be required as part of the safety related control system and risk reduction strategy (ISO12100-2, 4.5.1 and 4.5.2).

Refer to the relevant standard(s) to determine the safeguarding requirements for your application.

Mechanical Installation Guidelines

- The wire rope should be easily accessible and visible along its entire length. Markers or flags may be fixed on the rope to increase its visibility.
- Mounting points, including support points, must be rigid.
- The rope should be free of friction at all supports. Pulleys are recommended.
- Use only pulleys (not eye bolts) when routing the rope around a corner, or whenever direction changes, even slightly.
- Never run rope through conduit or other tubing.
- Never attach weights to the rope.
- Temperature affects rope tension. The rope expands (lengthens) when temperature increases, and contracts (shrinks) when temperature decreases. Significant temperature variations require frequent checks of the tension adjustment.
- Do not exceed the maximum specified total rope length. Banner offers models for other spans; contact the factory or visit www.bannerengineering.com for model selection.

Installation Procedure

1. Mount the switch securely on a solid, stationary surface.
2. Fasten an eye bolt at the opposite end of the rope span from the switch. Verify that the anchor for the eye bolt is solid and stationary, to withstand the constant tension and possible pull of the rope.
3. Assemble the rope, as shown. Keep the rope's PVC cover intact along its complete length, except where it attaches to the clamps at either end.
4. Use pulleys (recommended) or eye bolts at each support point. Always use a pulley when routing the rope around a corner, regardless of the angle.

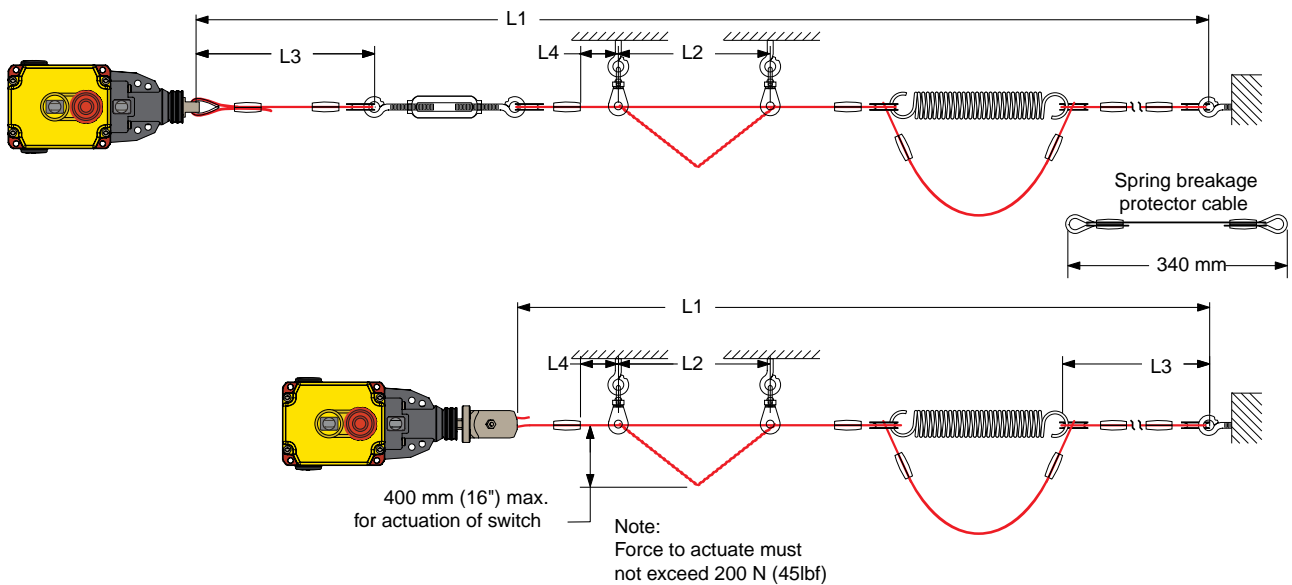

Figure 2: Assembly of rope and hardware (see Accessories section for components)

All hardware is supplied by the user. See Dimensions for switch mounting hole mounting pattern and size.

Switch Model	Max. Total Length L1	Max. Distance Between Pulleys L2	Max. Distance to Spring/Turnbuckle L3*	Min. Distance Fitting to Pulley L4**
75 m	75 m (245')	3-5 m (10-15')	150 mm (6")	150 mm (6")
38 m	37.5 m (123')			
*Closer, if possible				
**Distance must allow necessary clearance to all mounting hardware.				

Installing Models RP-RM83F-..LT and RP-RM83F-..LTE

These models have their own internal turnbuckle and clamp to tension the rope and to hold it in place. This innovative design provides for quick and easy rope fixing and tensioning, and requires no external turnbuckle, nor any additional clamp at the switch end of the rope.

To install the rope at the switch end, strip away several inches of the cable covering. Loosen the set screw on the switch fitting, using a 4 mm hex wrench. Insert the cable into the center hole, and pull the cut end out from the side hole. When the tension is correct, tighten the set screw to hold the rope firmly in place.

Tensioning the Rope (All Models)

After the rope span components are installed, apply tension to the rope until the arrows in the tensioning indicator are centered on the line in the indicator window. This indicates sufficient rope tension. (Contacts 11/12 will close.)

Models RP-RM83F-..LR and RP-RM83F-..LRE: Turn the turnbuckle until the arrows are centered.

Models RP-RM83F-..LT and RP-RM83F-..LTE: Turn the shaft of the switch using a 17 mm wrench as shown, until the arrows are centered.

Pull hard on the rope and reset the latch several times. If the arrows in the tensioning indicator window do not return to the correct position (centered on the line in the window), further tighten or loosen the rope tension as needed, then reset, until proper tension is shown.

Figure 3: Tightening the rope into the internal turnbuckle (models RP-RM83F-..LT and -..LTE)



Tension Indicator (All Models)

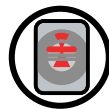

Too Little Tension Shown



Proper Tension Shown

Figure 4: Adjusting rope tension (models RP-RM83F-..LT and -..LTE)



Electrical Installation

Access to Wiring Chamber

Access the wiring chamber by loosening the 4 corner screws to remove the front cover. Select the best wiring entrance and thread in the 1/2" x 14 NPSM conduit adapter (supplied), or the optional M20 x 1.5 cable gland (see Accessories).

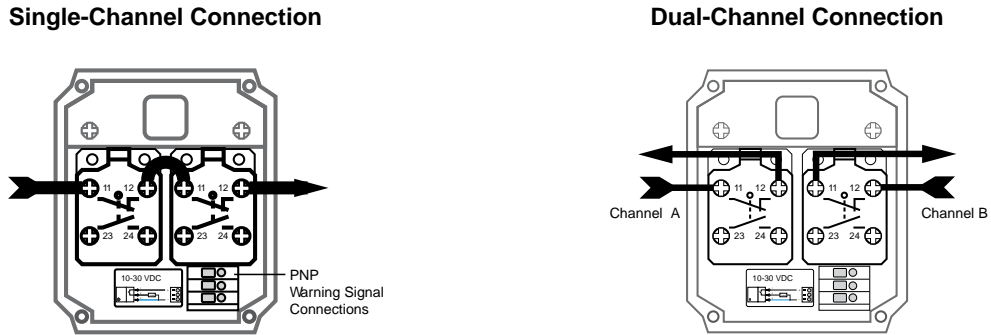

Figure 5: Wire the two switch contacts in series or independently, as described below

Wiring

These switch models have redundant pairs of safety contacts, so they may be wired for either single-channel or dual-channel output to a safety module or E-stop circuit. Monitor contacts may be wired as desired to an external alarm device.

CAUTION . . . Proper Wiring

Maximum tightening torque of contact screws is specified at 0.8 Nm; **do not over-tighten**. Before closing the front cover, verify that no wires are trapped. **Do not operate the rope pull without properly closing the cover.**

Single-Channel Output: Wire both 11/12 contacts in series to the input of a safety module or E-stop circuit.

Dual-Channel Output: Wire both 11/12 contacts independently to the two safety module inputs.

"Warning Signal"

Switch models **RP-RM83F-...E** provide a 24V dc solid-state "warning signal" output, that signals when the rope tension is either too high or too low, *before* the safety contacts open and the switch latches OFF. This solid-state switch is located inside the wiring chamber next to the safety output contacts.

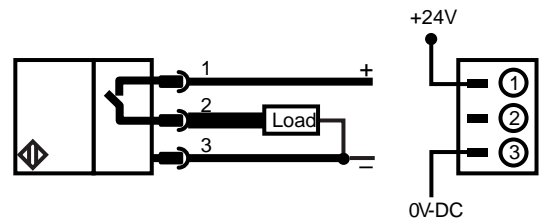

Figure 6: Warning signal electrical connections

E-Stop Reset

E-Stop and Latch Reset

After the rope is pulled or the E-stop button is pressed, the latch must be reset.

The E-stop can be reset only when proper tension is indicated. Pull the red E-stop button until the switch Status indicator changes from Yellow to Green and the latch makes an audible “click,” indicating that the latch has been reset.

NOTE: Proper rope tension must be displayed before the latch can be reset.

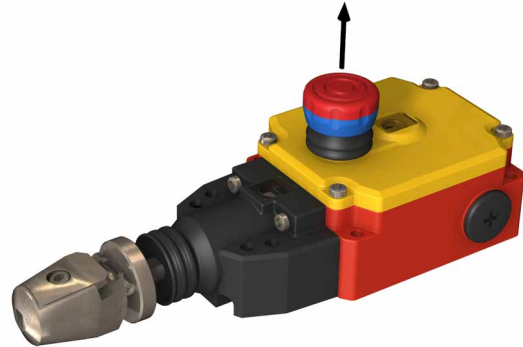

Figure 7: Resetting the latch

Maintenance

Test each rope pull emergency stop installation for proper machine shutdown response at each shift change or machine setup; this should be performed by a Designated Person*. In addition, a Qualified Person* should check for proper rope tension and adjust as needed, on a periodic schedule determined by the user, based upon severity of the operating environment and the frequency of switch actuations.

Periodically lubricate the pulleys and other moving parts associated with the rope. If inspection reveals dirt on the rope pull switch or rope assembly, clean off the dirt and eliminate its cause. Replace the rope pull switch and/or rope assembly when any parts (including contacts) or assemblies are found to be damaged, broken, deformed, or badly worn.

Replace the rope pull switch and rope assembly at specified intervals, based upon the environment and operating conditions. Consider replacement of the rope pull switch and rope assembly after no more than 100,000 operations. **Always test the control system for proper functioning under machine control conditions after maintenance or replacement of the rope pull switch.**

* A **Designated Person** is identified in writing by the employer as being appropriately trained to perform a specified checkout procedure. A **Qualified Person** possesses a recognized degree or certificate or has extensive knowledge, training, and experience to be able to solve problems relating to the emergency stop rope pull switch installation.

Repairs

Do not attempt any repairs to the rope pull emergency stop switch. It contains no field-replaceable components. Return it to the factory for warranty repair or replacement, as follows.







Contact Banner Factory Application Engineering at the address or the numbers listed on the back page. They will attempt to troubleshoot the system from your description of the problem. If they conclude that a component is defective, they will issue a return merchandise authorization (RMA) number for your paperwork, and give you the proper shipping address.

Pack the rope pull switch carefully. Damage which occurs in return shipping is not covered by warranty.



Specifications

Category	Description									
Contact Rating	10A @ 24V ac, 10A @ 110V ac, 6A @ 230V ac									
	6A @ 24V dc									
	2.5 kV max. transient tolerance									
	NEMA A300 P300									
Monitoring Solid-State Output Rating	Rated operational voltage: Ue = 10 to 30V dc									
	Rated operational current: Ie = 50 mA									
	Utilization category: DC13									
	Protected against reverse polarity and short circuit.									
European Rating	Utilization categories: AC15 and DC13									
	Ui = 500V ac									
	Ith = 10A									
	Rated surge capacity: 2.5 kV									
40-60 Hz										
	<table border="1" style="width: 100%; text-align: center;"> <thead> <tr> <th>Ue V</th> <th>Ie/AC-15 A</th> <th>Ie/DC-13</th> </tr> </thead> <tbody> <tr> <td>120</td> <td>6</td> <td>0.55</td> </tr> <tr> <td>240</td> <td>3</td> <td>0.27</td> </tr> </tbody> </table>	Ue V	Ie/AC-15 A	Ie/DC-13	120	6	0.55	240	3	0.27
Ue V	Ie/AC-15 A	Ie/DC-13								
120	6	0.55								
240	3	0.27								
Contact Material	Silver-nickel alloy									
Maximum Switching Speed	20 operations per minute									
Recommended Rope Size	Accommodates rope sizes 2 to 5 mm diameter steel rope (see Accessories); select rope diameter based on switch model and rope length									
	75 m models: recommended 2 to 5 mm dia.									
	38 m models: recommended 2 to 5 mm dia.									
Maximum Rope Pull Length	75 m (245') or 37.5' (123'), depending on model									
Short Circuit Protection	10 amp Slow Blow, 15 amp Fast Blow. Recommended external fusing or overload protection.									
Mechanical Life	100,000 operations									
Wire Connections	Screw terminals with pressure plates accept the following wire sizes –									
	Stranded and solid: 20 AWG (0.5 mm ²) to 16 AWG (1.5 mm ²) for one wire									
	Stranded: 20 AWG (0.5 mm ²) to 18 AWG (1.0 mm ²) for two wires									
Cable Entry	M20 x 1.5 threaded entrance. Adapter supplied to convert M20 x 1.5 to ½" - 14 NPT threaded entrance									
Construction	Die-cast aluminum housing; zinc die-cast actuator									
Environmental Rating	NEMA 4, IEC IP67 per IEC/EN 60529									
Operating Conditions	Temperature: -30° to +80° C (-34° to +176° F)									
Weight	RP-RM83F-..LT and -..LTE: 1 Kg (2.1 lbs.)									
	RP-RM83F-..LR and -..LRE: 0.77 Kg (1.6 lbs.)									
Product Performance Standards	DIN EN 60947-1, DIN EN 60947-5-1, DIN EN 60947-5-5, IEC 60947-1, IEC 60947-5-1, IEC 60947-5-5, ISO 13850									

Accessories

Models		Package Qty.	Description
	RPA-C1-10	10 m	2 mm steel wire rope with 0.5 mm red PVC jacket (unterminated)
	RPA-C1-20	20 m	
	RPA-C1-100	100 m	
	RPA-C2-10	10 m	3 mm steel wire rope with 0.5 mm red PVC jacket (unterminated)
	RPA-C2-20	20 m	
	RPA-C2-50	50 m	
	RPA-C2-80	80 m	
	RPA-C3-20	20 m	4 mm steel wire rope with 0.5 mm red PVC jacket (unterminated)
	RPA-C3-100	100 m	
Thimbles	RPA-T1-4	4 pcs	Thimble for 2 mm wire rope
	RPA-T2-4	4 pcs	Thimble for 3 mm wire rope
	RPA-T3-4	4 pcs	Thimble for 4 mm wire rope
Clamps	RPA-CC1-4	4 pcs	Clamp for 2 mm wire rope
	RPA-CC2-4	4 pcs	Clamp for 3 mm wire rope
	RPA-CC3-4	4 pcs	Clamp for 4 mm wire rope
Turnbuckles	RPA-TA1-1	1 pc	#4 Turnbuckle
			
Eye Bolts	RPA-EB1-1	1 pc	1/4" - 20 Eye bolt
			
Pulleys	RPA-P1-1	1 pc	Hanging pulley for in-line use
			
	RPA-DP1-1	1 pc	Right-angle mount deflection pulley for corner turns (90 to 180 degrees)

RP-RM83F-.. Heavy-Duty Rope Pulls

Models		Package Qty.	Description
Tensioning Springs	RPA-S3-1	1 pc	Tensioning spring #3 for use with model RP-RM83F-..75..
	RPA-S5-1	1 pc	Tensioning spring #5 for use with model RP-RM83F-..38..
Tensioning Spring Assemblies	RPA-S4-1	1 pc	Tensioning spring assembly: built-in eye bolt, cable thimble, clamp, tensioning, and overload protection. Use RPA-S4-1 for model RP-RM83F-..75.. , and use RPA-S6-1 for model RP-RM83F-..38..
	RPA-S6-1	1 pc	
Cable Gland	SI-QM-CGM20	1 pc	For cable diameters 5.0 to 12.0 mm (0.20" to 0.47"); M20 x 1.5 metal
Conduit Adaptor	SI-QM-M20	1 pc	1 conduit adaptor is supplied with each switch. 1/2"-14 NPT metal, M20 x 1.5 to 1/2"-NPT thread conversion



Warranty: Banner Engineering Corp. will repair or replace, free of charge, any product of its manufacture found to be defective at the time it is returned to the factory during the warranty period. This warranty does not cover damage or liability for the improper application of Banner products. This warranty is in lieu of any other warranty either expressed or implied.

**For more information:
Contact your local Banner
representative or Banner
Corporate Offices around
the world.**

Corporate Headquarters

Banner Engineering Corp. 9714 Tenth Ave.
North Mpls., MN 55441
Tel: 763-544-3164
www.bannerengineering.com
sensors@bannerengineering.com

Europe

Banner Engineering Europe Park Lane
Culliganlaan 2F Diegem
B-1831 BELGIUM Tel:
32-2 456 07 80 Fax: 32-2
456 07 89
www.bannereurope.com
mail@bannereurope.com

Latin America

Contact Banner
Engineering Corp. (US) or
e-mail **Mexico:**
mexico@bannerengineering.com
Brazil:
brasil@bannerengineering.com

Asia China

Banner Engineering China
Shanghai Rep Office Rm.
G/H/I, 28th Flr. Cross
Region Plaza No. 899,
Lingling Road Shanghai
200030 CHINA Tel:
86-21-54894500 Fax:
86-21-54894511
www.bannerengineering.com.cn
sensors@bannerengineering.com.cn

Asia Japan

Banner Engineering Japan Cent-Urban
Building 305 3-23-15
Nishi-Nakajima
Yodogawa-Ku, Osaka
532-0011 JAPAN Tel:
81-6-6309-0411 Fax:
81-6-6309-0416
www.bannerengineering.co.jp
mail@bannerengineering.co.jp

Asia

Banner Engineering Asia Taiwan Neihu Technology
Park 5F-1, No. 51, Lane 35,
Jihu Rd. Taipei 114
TAIWAN Tel:
886-2-8751-9966 Fax:
886-2-8751-2966
www.bannerengineering.com.tw
info@bannerengineering.com.tw

India

Banner Engineering India
Pune Head Quarters Office
No. 1001 Sai Capital, Opp.
ICC Senapati Bapat Road
Pune 411016 INDIA Tel:
91-20-66405624 Fax:
91-20-66405623
www.bannerengineering.co.in
india@bannerengineering.com