

PC SCREW TERMINALS

These easy-to-mount, multipurpose screw type terminals are a practical, low-cost alternative to PC screw type edge connectors, barrier blocks, terminal boards and terminal strips. Steadfast and easy to install, will accommodate solid or stranded wire, crimp type terminals or lugs. Multi-placement of these low-profile terminals make them ideally suited for high density packaging. Supplied unassembled or with screw installed and captivated.

PRINCIPAL FEATURES

- Low profile
- Stable, no-rock design with exclusive anti-rotational feature
- Easily mounts with four legs into pre-drilled or punched holes
- Accepts 14-22 AWG solid or stranded wire, crimp type terminals or lugs
- Ideally suited for high-density packaging
- Available in horizontal or vertical mounting
- Space-saving and time saving
- Easy accessibility for PC board testing
- Binding screw is positioned above board level to avoid wicking during wave soldering
- Terminals are made of Brass with Tin Plate
- Supplied with a combination drive 6-32 binding head screw
- Color coded screws available (add color screw suffix to Cat. No.)

CAT. NO. COLOR SUFFIX
 Ex: XXXX -X

COLOR SELECTION:
 Select desired screw terminal and add color suffix to the screw terminal Cat. No.

HEAD COLOR	SUFFIX
RED	-2
BLACK	-3
WHITE	-4
BLUE	-5
GREEN	-6
YELLOW	-7
NICKEL	none

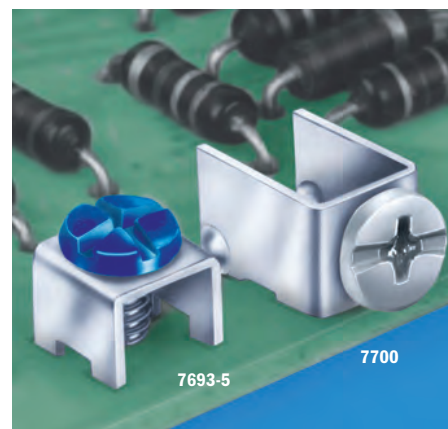

SCREW TERMINALS



7692-2
 SNAP-IN PC MOUNT

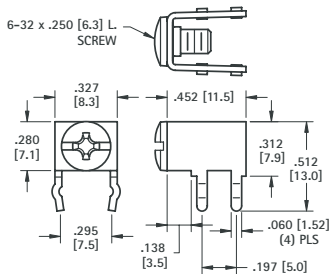

- CAT. NO. 7779** (Supplied Less Screw)
- CAT. NO. 7690** (Screw Supplied Unassembled)
- CAT. NO. 7692** (Screw Installed & Captivated)

HORIZONTAL TYPE

SPECIFICATIONS
 Rated: 15 Amps
 Terminal: .032 (.81) thick Brass, Tin Plate
 Binding Head Screw: Brass, Nickel Plate

Mounting Detail

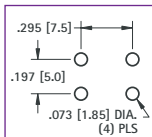

Color coded screws available (add color screw suffix to Cat. No.)

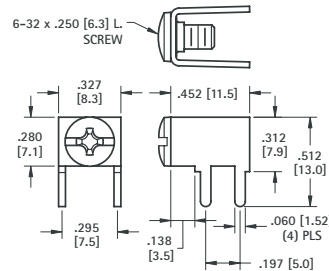

7700-3
 PC MOUNT

- CAT. NO. 7781** (Supplied Less Screw)
- CAT. NO. 8190** (Screw Supplied Unassembled)
- CAT. NO. 7700** (Screw Installed & Captivated)



7693-4
 SNAP-IN PC MOUNT

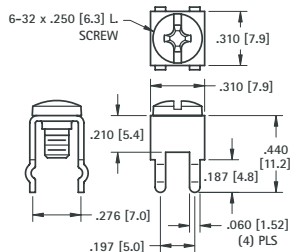

- CAT. NO. 7780** (Supplied Less Screw)
- CAT. NO. 7691** (Screw Supplied Unassembled)
- CAT. NO. 7693** (Screw Installed & Captivated)

VERTICAL TYPE

SPECIFICATIONS
 Rated: 15 Amps
 Terminal: .032 (.81) thick Brass, Tin Plate
 Binding Head Screw: Brass, Nickel Plate

Mounting Detail

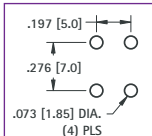

Color coded screws available (add color screw suffix to Cat. No.)

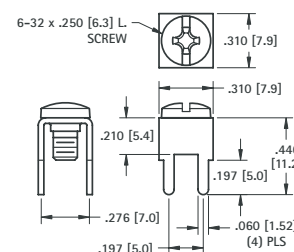

7701
 PC MOUNT

- CAT. NO. 7782** (Supplied Less Screw)
- CAT. NO. 8191** (Screw Supplied Unassembled)
- CAT. NO. 7701** (Screw Installed & Captivated)



7699-6
 PC MOUNT

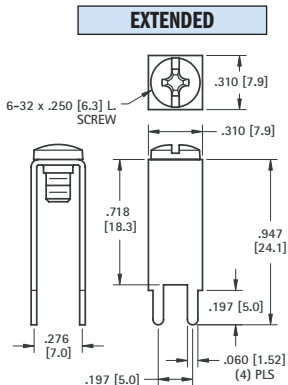

- CAT. NO. 7789** (Supplied Less Screw)
- CAT. NO. 7697** (Screw Supplied Unassembled)
- CAT. NO. 7699** (Screw Installed & Captivated)

SPECIFICATIONS
 Rated: 15 Amps
 Terminal: .032 (.81) thick Brass, Tin Plate
 Binding Head Screw: Brass, Nickel Plate

Color coded screws available (add color screw suffix to Cat. No.)

Mounting Detail

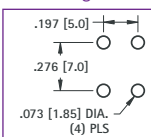

45°

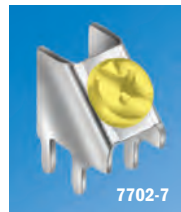
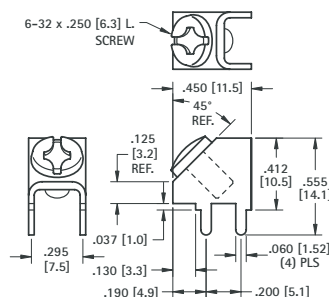

7702-7
 PC MOUNT

Mounting Detail

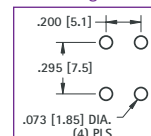

- CAT. NO. 7783** (Supplied Less Screw)
- CAT. NO. 8189** (Screw Supplied Unassembled)
- CAT. NO. 7702** (Screw Installed & Captivated)

COLOR CODED SCREW TERMINAL SELECTION GUIDE



Color Coded Screw Terminals

provide:

- Quick identification
- Visibility for field service troubleshooting

SPECIFICATIONS

Combination Binding Head:

Standard screw is Brass, Nickel Plate. For painted, color head, add suffix as shown.



COLOR SELECTION:
Select desired screw terminal and add color suffix to the screw terminal Cat. No.

HEAD COLOR	SUFFIX
RED	-2
BLACK	-3
WHITE	-4
BLUE	-5
GREEN	-6
YELLOW	-7
NICKEL	none

CAT. NO. COLOR SUFFIX
Ex: XXXX -X



Refer to page 123 for color screws only

- Available for screw terminals where noted.

LOW PROFILE - PC SCREW TERMINALS

These easy to mount screw terminals are ideally suited for high density packaging and are available unassembled or with the screw installed and captivated. They are a practical alternative to PC screw type edge connectors, barrier blocks, terminal boards and terminal strips.



PRINCIPAL FEATURES

- Low profile
- Stable, no-rock design
- Easily mounts in pre-drilled or stamped holes
- Accepts 12-22 AWG solid or stranded wire, crimp type terminals or lugs
- Space saving and time saving
- Combination drive, binding head screw
- Color coded screws available (add color screw suffix to Cat. No.)

SPECIFICATIONS

Rated: 15 Amps
Terminal: .032 (.81) thick Brass, Tin Plate
Binding Head Screw: Brass, Nickel Plate

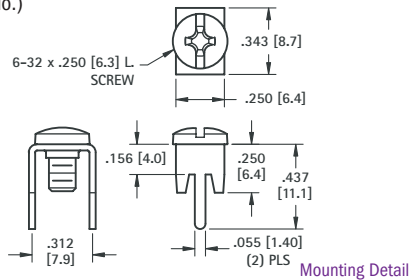

Mounting Detail

- CAT. NO. 7784** (Supplied Less Screw)
- CAT. NO. 8198** (Screw Supplied Unassembled)
- CAT. NO. 7778** (Screw Installed & Captivated)

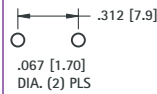

A practical, low-cost alternative to PC screw type edge connectors, barrier blocks, terminal boards and terminal strips. Supplied unassembled or with screw installed and captivated.



PRINCIPAL FEATURES

- Low profile
- Stable, no-rock design with exclusive anti-rotational feature
- Ideally suited for high-density packaging
- Space saving and time saving
- Combination drive, binding head screw
- Color coded screws available (add color screw suffix to Cat. No.)

SPECIFICATIONS

Rated: 15 Amps
Terminal: .032 (.81) thick Brass, Tin Plate
Binding Head Screw: Brass, Nickel Plate

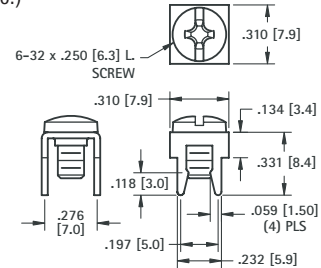

Mounting Detail

- CAT. NO. 7785** (Supplied Less Screw)
- CAT. NO. 8195** (Screw Supplied Unassembled)
- CAT. NO. 7775** (Screw Installed & Captivated)

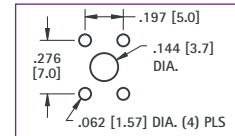

30 AMP - PC SCREW TERMINALS

A practical, low-cost alternative to PC screw type edge connectors, barrier blocks, terminal boards and terminal strips. Supplied unassembled or with screw installed and captivated.



PRINCIPAL FEATURES

- Compact, heavy duty design
- Six snap-in legs for total stability
- Serrated top surface secures connection
- Combination drive, binding head screw
- Color coded screws available (add color screw suffix to Cat. No.)

SPECIFICATIONS

Rated: 30 Amps
Terminal: .032 (.81) thick Brass, Tin Plate
Binding Head Screw: Brass, Nickel Plate

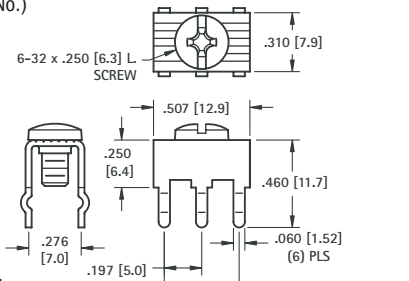

Mounting Detail

- CAT. NO. 7786** (Supplied Less Screw)
- CAT. NO. 8197** (Screw Supplied Unassembled)
- CAT. NO. 8199** (Screw Installed & Captivated)

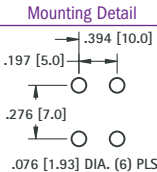

HEAVY DUTY

This heavy duty screw terminal has been designed to carry 30 Amps, while maintaining a space saving compact profile, making it ideal for high density packaging.



PRINCIPAL FEATURES

- Compact, heavy duty design
- Six snap-in legs for total stability
- Serrated top surface secures connection

SPECIFICATIONS

Rated: 30 Amps
Terminal: .045 (1.14) thick Brass, Tin Plate
Screw: Stainless Steel

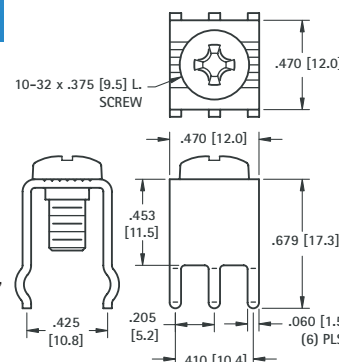

Mounting Detail

- CAT. NO. 7787** (Supplied Less Screw)
- CAT. NO. 8196** (Screw Supplied Unassembled)

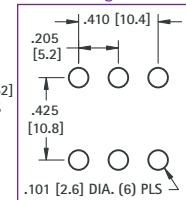

METRIC - "SNAP-IN" PC SCREW TERMINALS



Mounting Detail

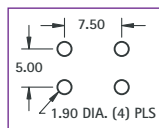

- CAT. NO. 7790** (Supplied Less Screw)
- CAT. NO. 7689** (Screw Supplied Unassembled)
- CAT. NO. 7695** (Screw Installed & Captivated)

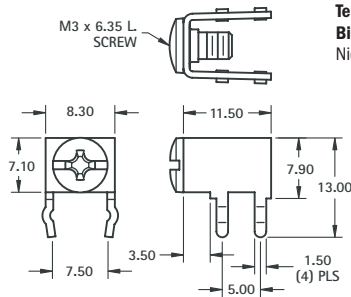

M3 HORIZONTAL

SPECIFICATIONS

Rated: 15 Amps
Terminal: 0.81 thick Brass, Tin Plate
Binding Head Screw: Brass, Nickel Plate

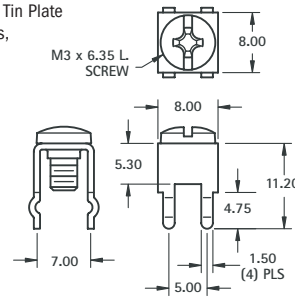

M3 VERTICAL

- CAT. NO. 7788** (Supplied Less Screw)
- CAT. NO. 7698** (Screw Supplied Unassembled)
- CAT. NO. 7696** (Screw Installed & Captivated)



Mounting Detail

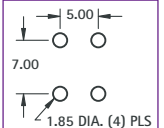

NOTE: All dimensions are in millimeters

LOW PROFILE SCREW TERMINALS

These sturdy, low cost screw terminals, feature an anti-rotation tab for use with spade terminals. They are available with the screw installed and captivated, the screw unassembled or without a screw.



6-32

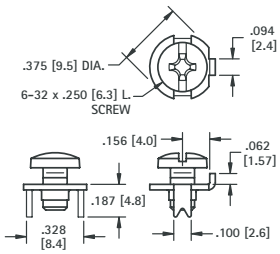

SPECIFICATIONS

Rated: 15 Amps
Terminal: .032 (.81) thick Brass, Tin Plate
Screw: Combination drive, Stainless Steel

- CAT. NO. 1284** (Supplied Less Screw)
- CAT. NO. 1298** (Screw Supplied Unassembled)
- CAT. NO. 1201** (Screw Installed & Captivated)

Mounting Detail

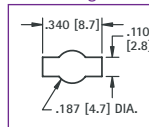

PRINCIPLE FEATURES

- Easy to connect using solid or stranded wire, crimp lugs or terminals
- Anti-rotation tab for use with spade terminals
- Supplied with screw installed and captivated, with screw unassembled, or without screw
- Stainless steel screw will not wick



10-32

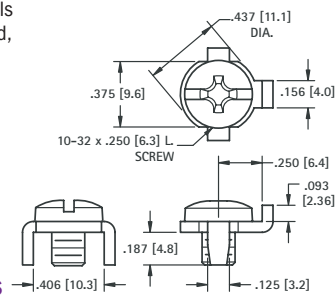

SPECIFICATIONS

Rated: 30 Amps
Terminal: .062 (1.6) thick Brass, Tin Plate
Screw: Combination drive, Stainless Steel

- CAT. NO. 1293** (Supplied Less Screw)
- CAT. NO. 1299** (Screw Supplied Unassembled)
- CAT. NO. 1202** (Screw Installed & Captivated)

Mounting Detail

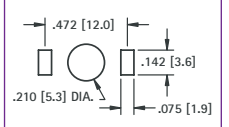

HEAVY DUTY SCREW TERMINALS

These heavy duty terminals are available with the screw installed or unassembled, and feature easy access to connect solid or stranded wire, crimp type lugs or terminals.



8-32

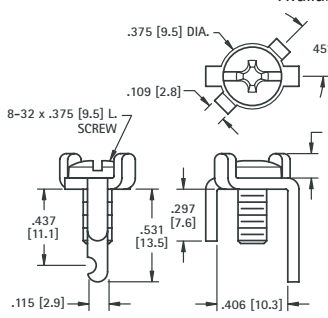

SPECIFICATIONS

Rated: 15 Amps
Terminal: .064 (1.6) thick Brass, Tin Plate
Screw: Brass, Nickel Plate

- CAT. NO. 1205** (Supplied Less Screw)
- CAT. NO. 1207** (Screw Supplied Unassembled)
- CAT. NO. 1209** (Screw Installed)

Mounting Detail

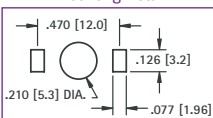

PRINCIPLE FEATURES

- Anti-rotation tab for use with spade terminals
- Below the board notched leg, to facilitate mechanical and solder connections
- Easy to connect using solid or stranded wire, crimp lugs or terminals
- Available with screw installed, unassembled, or without screw



10-32

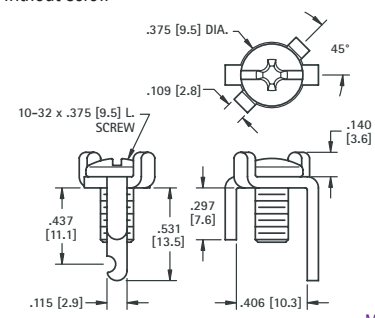

SPECIFICATIONS

Rated: 30 Amps
Terminal: .064 (1.6) thick Brass, Tin Plate
Screw: Steel, Nickel Plate

- CAT. NO. 1206** (Supplied Less Screw)
- CAT. NO. 1208** (Screw Supplied Unassembled)
- CAT. NO. 1283** (Screw Installed)

Mounting Detail

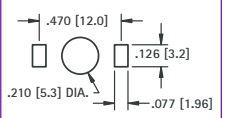

SCREW TERMINALS

OFFSET LEG

6-32

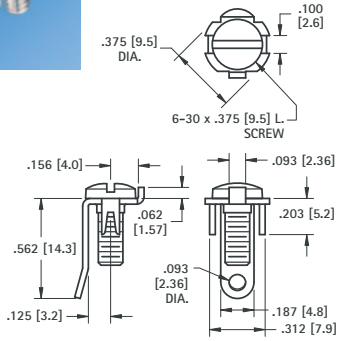

Mounting Detail

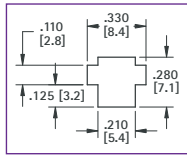

SPECIFICATIONS

Terminal: .032 (.81) thick Steel, Tin Plate
Screw: Steel, Nickel Plate (Screw Installed & Captivated)

CAT. NO. 1248

STRAIGHT LEG

6-32

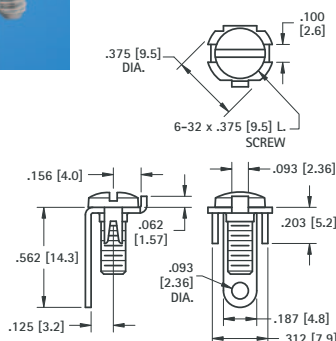

Mounting Detail

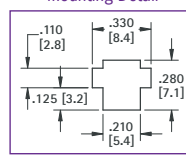

SPECIFICATIONS

Terminal: .032 (.81) thick Steel, Tin Plate
Screw: Steel, Nickel Plate (Screw Installed & Captivated)

CAT. NO. 1215

SOLDER TAB

6-32

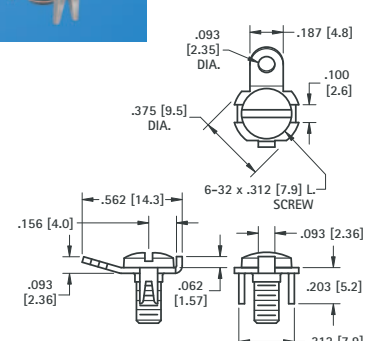

Mounting Detail

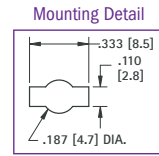

SPECIFICATIONS

Terminal: .032 (.81) thick Steel, Tin Plate
Screw: Steel, Nickel Plate (Screw Installed & Captivated)

CAT. NO. 1232

SNAP-FIT SCREW TERMINALS

SOLDER

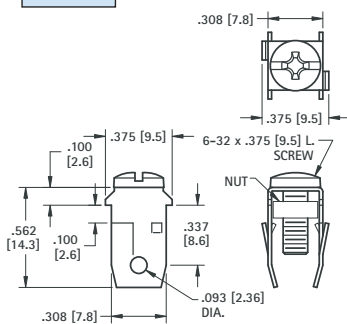

Mounting Detail

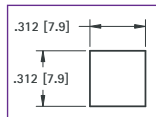

SPECIFICATIONS

Terminal: .020 (.51) thick Spring Steel, Tin Plate
Screw: Steel, Zinc Plate, (Screw Installed & Captivated)

CAT. NO. 1272

.187 (9.8) QUICK-FIT

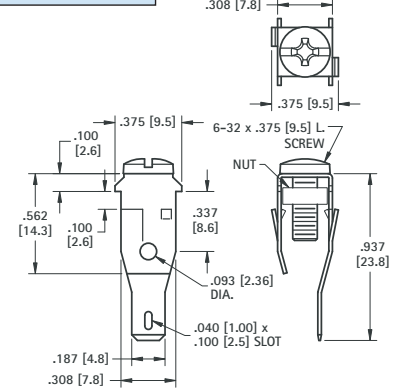

SPECIFICATIONS

Terminal: .020 (.51) thick Spring Steel, Tin Plate
Screw: Steel, Zinc Plate, (Screw Installed & Captivated)

CAT. NO. 1273

BINDING POST TERMINALS (RIVET TYPE)

4-40

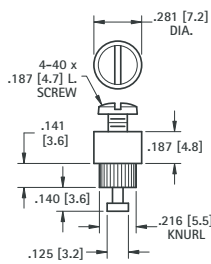

FOR .093 (2.38) BOARD

6-32

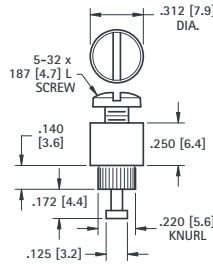

FOR .093 (2.38) BOARD

8-32

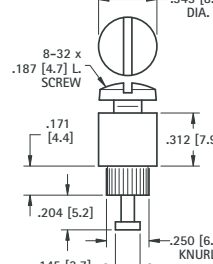

FOR .125 (3.2) BOARD

M2.5

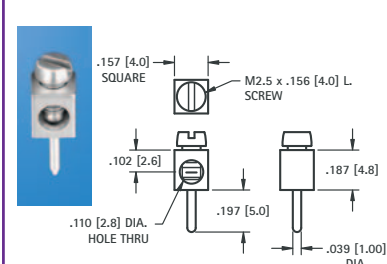

FOR .125 (3.2) BOARD

SPECIFICATIONS

Terminal: Brass, Tin Plate
Screw: Steel, Zinc Plate (Screw Supplied Unassembled)
Mounting Hole: .220 (5.6)

CAT. NO. 1537

SPECIFICATIONS

Terminal: Brass, Tin Plate
Screw: Steel, Zinc Plate (Screw Supplied Unassembled)
Mounting Hole: .225 (5.7)

CAT. NO. 1535

SPECIFICATIONS

Terminal: Brass, Tin Plate
Screw: Steel, Zinc Plate (Screw Supplied Unassembled)
Mounting Hole: .255 (6.5)

CAT. NO. 1536

SPECIFICATIONS

Terminal: Brass, Tin Plate
Screw: Steel, Zinc Plate (Screw Supplied Unassembled)
Mounting Hole: .047 (1.2)

CAT. NO. 8730