

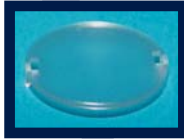

## NICHIA JUPITER® ADHESIVE-BACKED LENS



### FEATURES / BENEFITS

- ▲ For Nichia Jupiter LEDs
- ▲ Available in spot, diffuser, wide, and oval lenses
- ▲ Integral self-adhesive pad
- ▲ Snap-on sub-lens
- ▲ Greater than 85% efficiency

### OPERATING CONDITIONS

- ▲ 85° C max acrylic temperature
- ▲ 105° C adhesive max temperature

### MATERIALS/FINISH

- ▲ Optical grade PMMA acrylic

### ORDERING INFORMATION

BASE LENSES			
Dialight P/N	Reference P/N	Description	Degree*
OPIO1011	OPIO-1-011	OPIO Series Spot Base Module For Nichia Jupiter	11°
SUB-LENSES			
OPAA1DF	OPAA-1-DF	Diffuser Sub-Lens	13°
OPAA1WSL	OPAA-1-WSL	Wide Sub-Lens	18°
OPAA1OSL	OPAA-1-OSL	Oval Sub-Lens	12° X 24°
*All angles refer to half divergence			

Dialight reserves the right to make changes at any time  
in order to supply the best product possible.

#### Dialight-Lumidrives Ltd.

York House • Wetherby Road • Long Marston, York, YO26 7NH  
Tel: +44(0) 1904 739150 • Fax: +44(0) 1904 737926 • www.dialight.com



#### Dialight Corporation

1501 Route 34 South • Farmingdale, NJ 07727 USA  
Tel: (1) 732-919-3119 • Fax: (1) 732-751-5778 • www.dialight.com



MDEXLUMADBNJ\_C

### MECHANICAL DIMENSIONS

### PHOTOMETRIC DATA

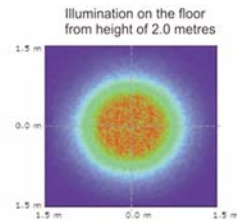
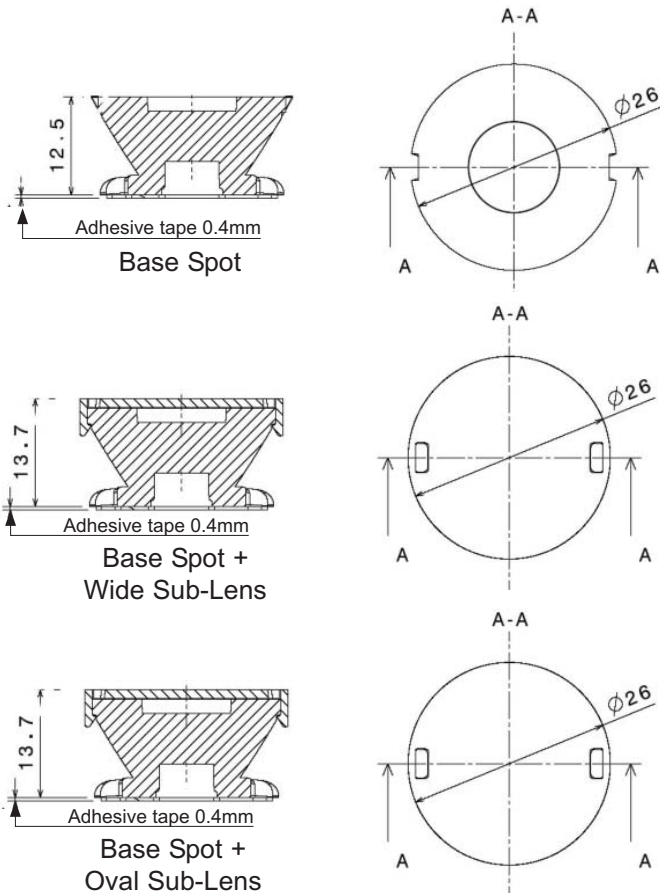

**OPIO Spot Module**

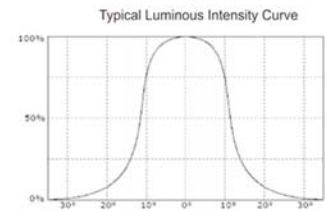

Typical Lens Efficiency: >85%  
Typical Half-Divergence Angle: 11°

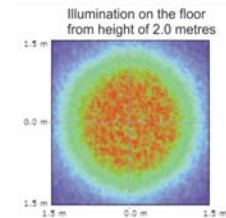

**OPIO Spot Module with Wide Sub Lens**

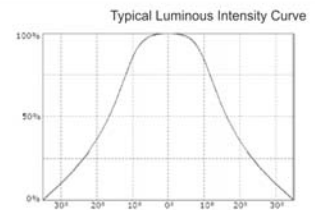

Typical Lens Efficiency: >85% - Typical Half-Divergence Angle: 18°

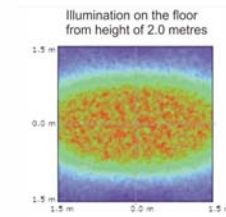

**OPIO Spot Module with Oval Sub Lens**

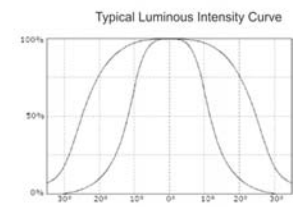

Typical Lens Efficiency: >85% - Typical Half-Divergence Angle: 12°x24°

Dialight reserves the right to make changes at any time in order to supply the best product possible.

#### Dialight-Lumidrives Ltd.

York House • Wetherby Road • Long Marston, York, YO26 7NH  
Tel: +44(0) 1904 739150 • Fax: +44(0) 1904 737926 • www.dialight.com



#### Dialight Corporation

1501 Route 34 South • Farmingdale, NJ 07727 USA  
Tel: (1) 732-919-3119 • Fax: (1) 732-751-5778 • www.dialight.com



MDEXLUMADBNJ\_C