



## TABLE OF CONTENTS

Features .....	1	Typical Performance Characteristics .....	6
Applications.....	1	Theory of Operation .....	10
Typical Applications Circuit.....	1	Applications Information .....	11
General Description .....	1	Capacitor Selection .....	11
Revision History .....	2	Ground Current.....	11
Specifications.....	3	Enable Feature .....	11
Timing Diagram .....	3	Timing .....	11
Absolute Maximum Ratings.....	4	Outline Dimensions .....	13
ESD Caution.....	4	Ordering Guide .....	13
Pin Configuration and Function Descriptions.....	5		

## REVISION HISTORY

3/11—Revision 0: Initial Version

## SPECIFICATIONS

$V_{IN} = 1.8\text{ V}$ ,  $V_{EN} = V_{IN}$ ,  $I_{OUT} = 1\text{ A}$ ,  $T_A = 25^\circ\text{C}$ , unless otherwise noted.

Table 1.

Parameter	Symbol	Test Conditions/Comments	Min	Typ	Max	Unit
INPUT VOLTAGE RANGE	$V_{IN}$	$T_J = -40^\circ\text{C}$ to $+85^\circ\text{C}$	1.8		5.5	V
EN INPUT						
EN Input	$V_{IH}$	$V_{IN} = 1.8\text{ V}$ to $5.5\text{ V}$	1.2			V
	$V_{IL}$	$V_{IN} = 1.8\text{ V}$ to $5.5\text{ V}$			0.4	V
EN Input Pull-Down Current	$I_{EN}$	$V_{IN} = 1.8\text{ V}$		500		nA
CURRENT						
Ground Current	$I_{GND}$	$V_{IN} = 1.8\text{ V}$		18		$\mu\text{A}$
		$V_{IN} = 3.4\text{ V}$		14		$\mu\text{A}$
		$V_{IN} = 4.2\text{ V}$ , $T_J = -40^\circ\text{C}$ to $+85^\circ\text{C}$		18	30	$\mu\text{A}$
		$V_{IN} = 5.5\text{ V}$		28		$\mu\text{A}$
Off State Current	$I_{OFF}$	$V_{EN} = \text{GND}$ , $V_{OUT} = 0\text{ V}$ , $V_{IN} = 4.2\text{ V}$		0.1		$\mu\text{A}$
		$V_{EN} = \text{GND}$ , $T_J = -40^\circ\text{C}$ to $+85^\circ\text{C}$ , $V_{OUT} = 0\text{ V}$ , $V_{IN} = 1.8\text{ V}$ to $5.5\text{ V}$			20	$\mu\text{A}$
Continuous Operating Current <sup>1</sup>	$I_{OUT}$	$V_{IN} = 1.8\text{ V}$ to $5.5\text{ V}$		3		A
VIN TO VOUT RESISTANCE	$R_{DS(ON)}$					
		$V_{IN} = 5.5\text{ V}$		0.012		$\Omega$
		$V_{IN} = 4.2\text{ V}$		0.012		$\Omega$
		$V_{IN} = 1.8\text{ V}$		0.012		$\Omega$
		$V_{IN} = 1.8\text{ V}$ , $T_J = -40^\circ\text{C}$ to $+85^\circ\text{C}$		0.012	0.017	$\Omega$
VOUT TURN-ON DELAY TIME		See Figure 2				
Turn-On Delay Time	$t_{ON\_DLY}$	$V_{IN} = 1.8\text{ V}$ to $5.5\text{ V}$ , $C_{LOAD} = 1\text{ }\mu\text{F}$		1		ms
THERMAL SHUTDOWN						
Thermal Shutdown Threshold	$T_{SD}$	$T_J$ rising		125		$^\circ\text{C}$
Thermal Shutdown Hysteresis	$T_{SD-HYS}$			15		$^\circ\text{C}$

<sup>1</sup> At an ambient temperature of  $85^\circ\text{C}$ , the part can withstand a continuous current of 2.22 A. At a load current of 3 A, the operational lifetime derates to 2190 hours.

## TIMING DIAGRAM

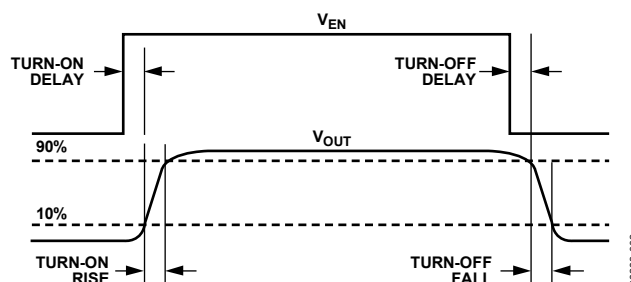

Figure 2. Timing Diagram

## ABSOLUTE MAXIMUM RATINGS

Table 2.

Parameter	Rating
V <sub>IN</sub> to GND	−0.3 V to +6.5 V
V <sub>OUT</sub> to GND	−0.3 V to V <sub>IN</sub>
EN to GND	−0.3 V to V <sub>IN</sub>
Continuous Drain Current	
T <sub>A</sub> = 25°C	±4 A
T <sub>A</sub> = 85°C	±2.22 A
Continuous Diode Current	−50 mA
Storage Temperature Range	−65°C to +150°C
Operating Junction Temperature Range	−40°C to +105°C
Soldering Conditions	JEDEC J-STD-020

Stresses above those listed under Absolute Maximum Ratings may cause permanent damage to the device. This is a stress rating only; functional operation of the device at these or any other conditions above those indicated in the operational section of this specification is not implied. Exposure to absolute maximum rating conditions for extended periods may affect device reliability.

Table 3. Typical  $\theta_{JA}$  and  $\Psi_{JB}$  Values

Package Type	$\theta_{JA}$	$\Psi_{JB}$	Unit
6-Ball, 0.5 mm Pitch WLCSP	260	58	°C/W

### ESD CAUTION



**ESD (electrostatic discharge) sensitive device.**

Charged devices and circuit boards can discharge without detection. Although this product features patented or proprietary protection circuitry, damage may occur on devices subjected to high energy ESD. Therefore, proper ESD precautions should be taken to avoid performance degradation or loss of functionality.

## PIN CONFIGURATION AND FUNCTION DESCRIPTIONS

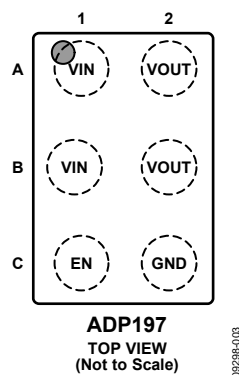

Figure 3. Pin Configuration

Table 4. Pin Function Descriptions

Pin No.	Mnemonic	Description
A1, B1	VIN	Input Voltage.
A2, B2	VOUT	Output Voltage.
C1	EN	Enable Input. Drive EN high to turn on the switch and drive EN low to turn off the switch.
C2	GND	Ground.

## TYPICAL PERFORMANCE CHARACTERISTICS

$V_{IN} = 1.8\text{ V}$ ,  $V_{EN} = V_{IN}$ ,  $C_{IN} = C_{OUT} = 1\ \mu\text{F}$ ,  $T_A = 25^\circ\text{C}$ , unless otherwise noted.

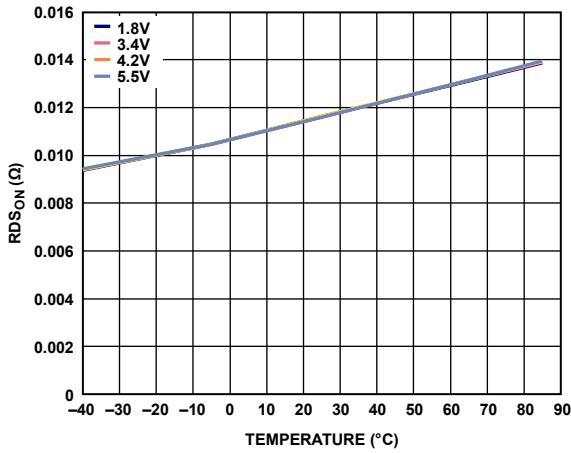

Figure 4.  $R_{DS(on)}$  vs. Temperature, 500 mA

09298-004

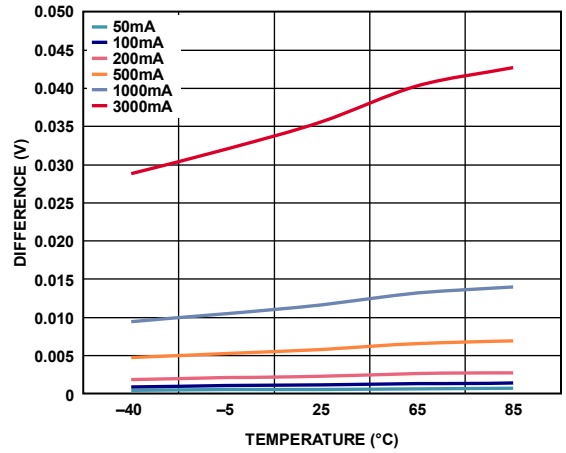

Figure 7. Voltage Drop vs. Temperature, Different Load Currents

09298-007

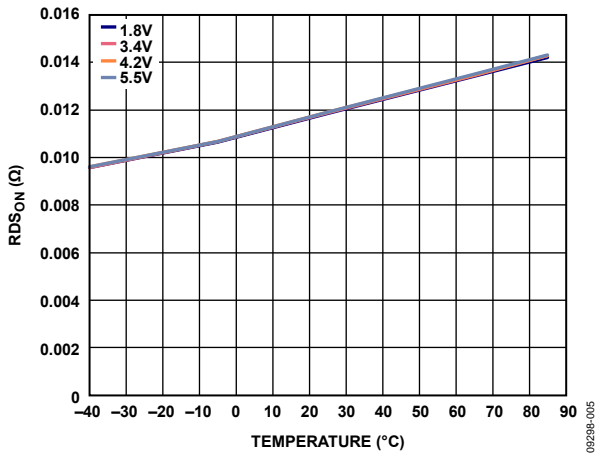

Figure 5.  $R_{DS(on)}$  vs. Temperature, 3 A, Different Input Voltages ( $V_{IN}$ )

09298-005

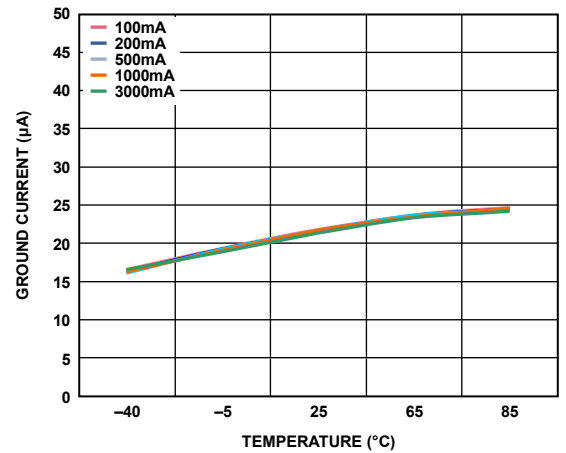

Figure 8. Ground Current vs. Temperature, Different Load Currents,  $V_{IN} = 1.8\text{ V}$

09298-016

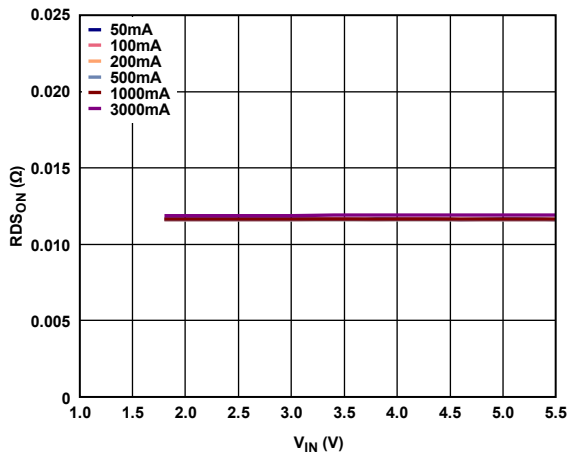

Figure 6.  $R_{DS(on)}$  vs. Input Voltage ( $V_{IN}$ ), Different Load Currents

09298-006

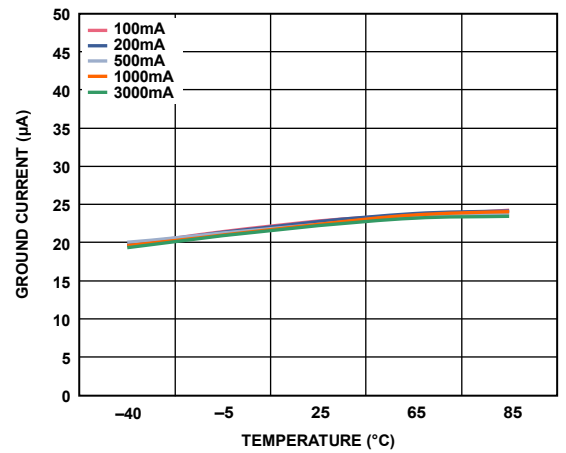

Figure 9. Ground Current vs. Temperature, Different Load Currents,  $V_{IN} = 4.2\text{ V}$

09298-017

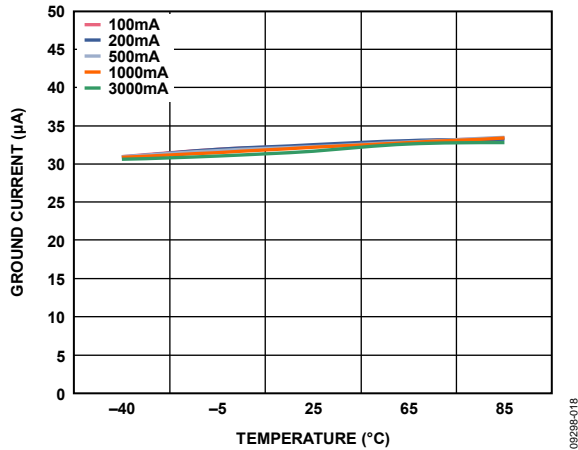

Figure 10. Ground Current vs. Temperature, Different Load Currents,  $V_{IN} = 5.5V$

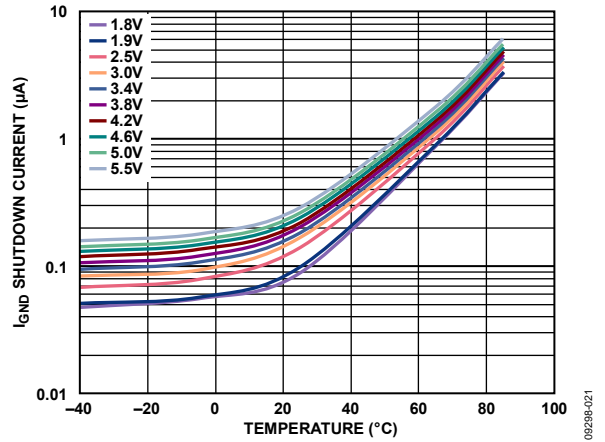

Figure 13. Ground Shutdown Current vs. Temperature,  $V_{OUT} = 0V$ , Different Input Voltages ( $V_{IN}$ )

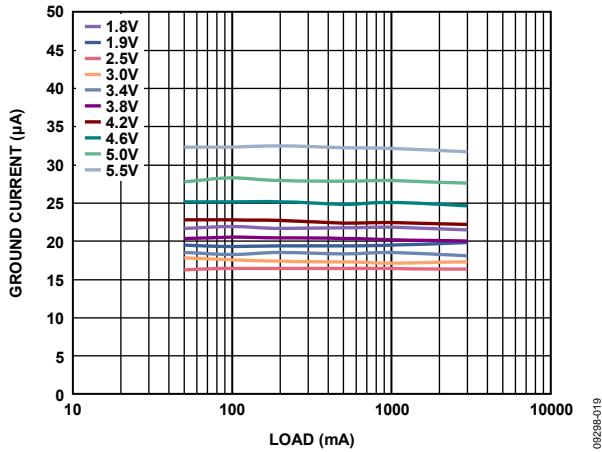

Figure 11. Ground Current vs. Load Current, Different Input Voltages ( $V_{IN}$ )

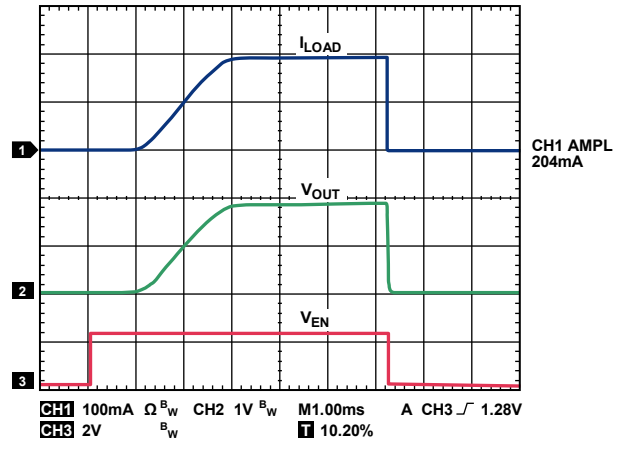

Figure 14. Typical Turn-On Time and Inrush Current,  $V_{IN} = 1.9V$ , 200mA Load

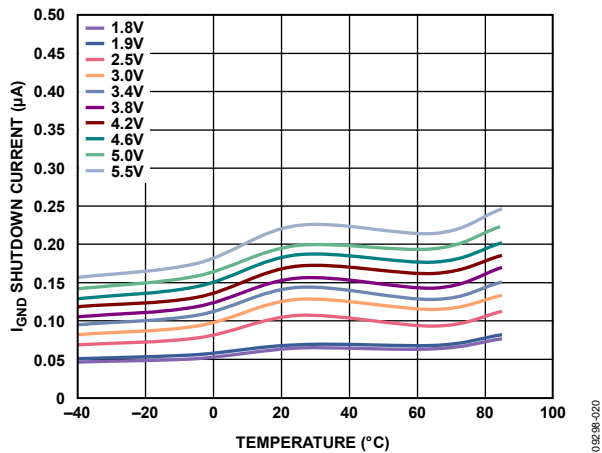

Figure 12. Ground Shutdown Current vs. Temperature, Output Open, Different Input Voltages ( $V_{IN}$ )

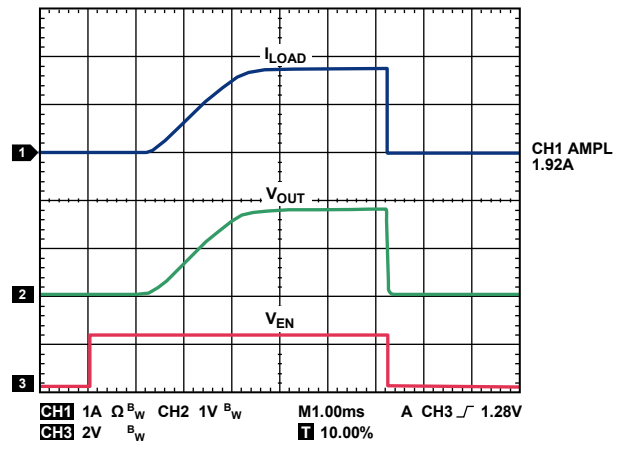

Figure 15. Typical Turn-On Time and Inrush Current,  $V_{IN} = 1.9V$ , 2A Load

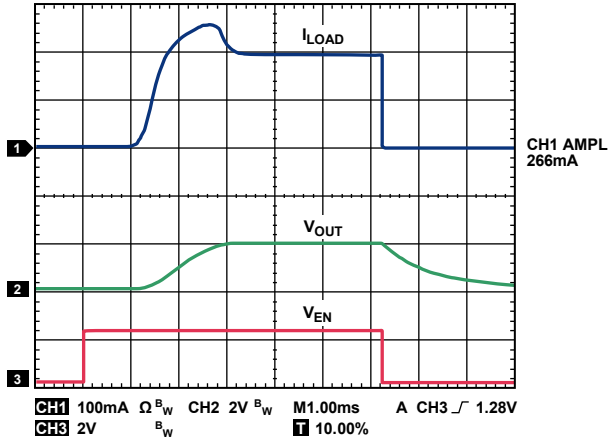

Figure 16. Typical Turn-On Time and Inrush Current,  $V_{IN} = 1.9V$ , 200 mA Load,  $C_{OUT} = 100\mu F$

09298-010

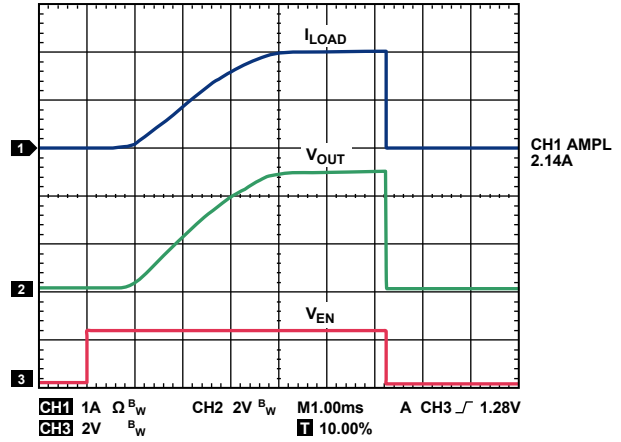

Figure 19. Typical Turn-On Time and Inrush Current,  $V_{IN} = 5.5V$ , 2 A Load

09298-013

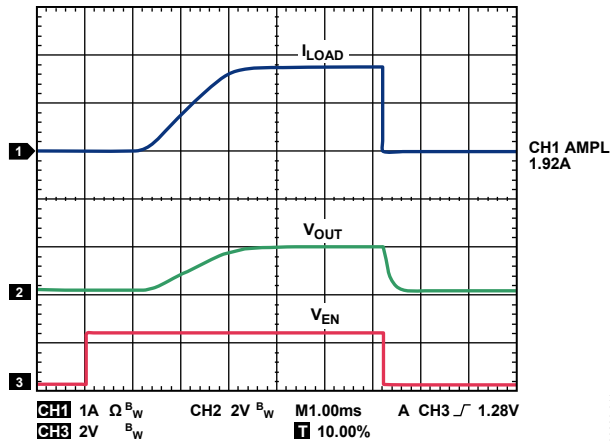

Figure 17. Typical Turn-On Time and Inrush Current,  $V_{IN} = 1.9V$ , 2 A Load,  $C_{OUT} = 100\mu F$

09298-011

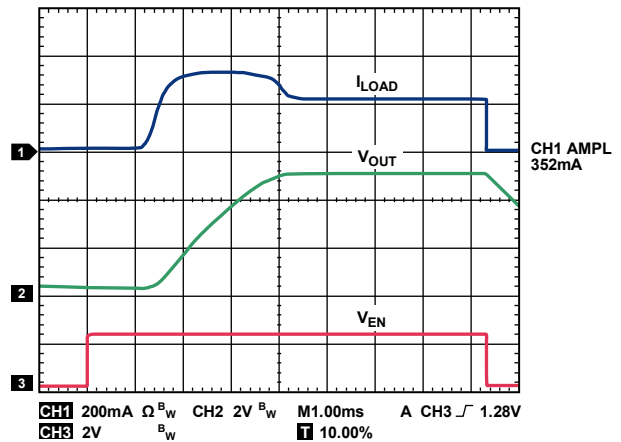

Figure 20. Typical Turn-On Time and Inrush Current,  $V_{IN} = 5.5V$ , 200 mA Load,  $C_{OUT} = 100\mu F$

09298-014

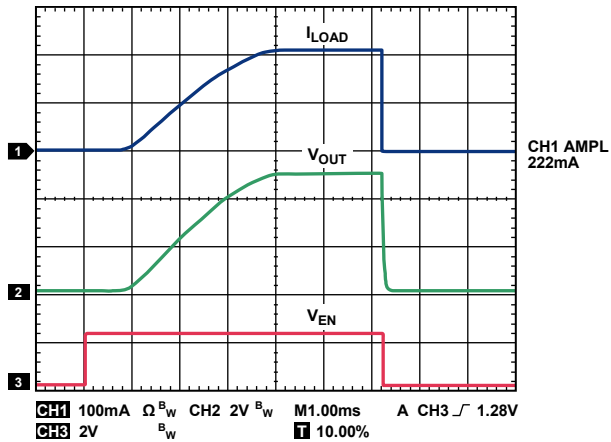

Figure 18. Typical Turn-On Time and Inrush Current,  $V_{IN} = 5.5V$ , 200 mA Load

09298-012

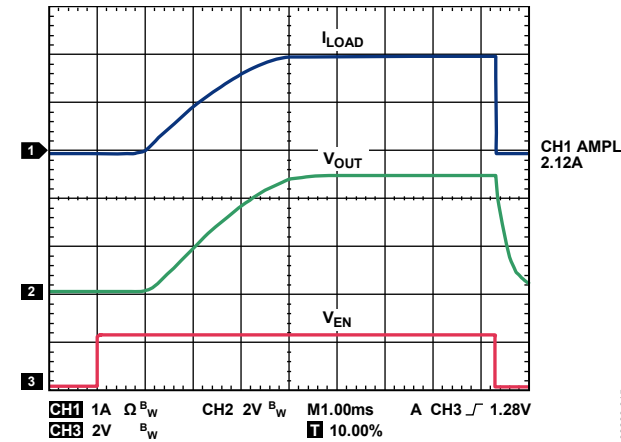

Figure 21. Typical Turn-On Time and Inrush Current,  $V_{IN} = 5.5V$ , 2 A Load,  $C_{OUT} = 100\mu F$

09298-015



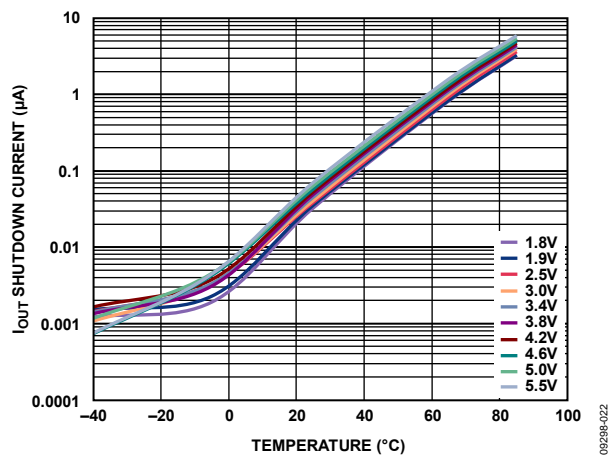

Figure 22. Output Shutdown Current vs. Temperature,  $V_{OUT} = 0 V$ , Different Input Voltages ( $V_{IN}$ )

## THEORY OF OPERATION

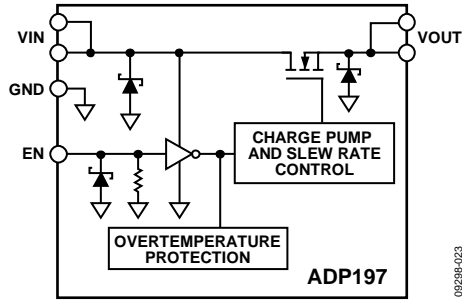

Figure 23. Functional Block Diagram

The ADP197 is a high-side NMOS load switch, controlled by an internal charge pump. The ADP197 is designed to operate with power supply voltages between 1.8 V and 5.5 V.

An internal charge pump biases the NMOS switch to achieve a relatively constant, ultralow on resistance of 12 m $\Omega$  across the entire input voltage range. The use of the internal charge pump also allows for controlled turn-on times. Turning the NMOS switch

on and off is controlled by the enable input, EN, which is capable of interfacing directly with 1.8 V logic signals.

The ADP197 is capable of 3 A of continuous current as long as  $T_j$  is less than 70°C. At 85°C, the rated current drops to 2.22 A.

The overtemperature protection circuit activates if the load current causes the junction temperature to exceed 125°C. When this occurs, the overtemperature protection circuitry disables the output until the junction temperature falls below approximately 110°C, at which point the output is reenabled. If the fault condition persists, the output cycles off and on until the fault is removed.

ESD protection structures are shown in the block diagram as Zener diodes.

The ADP197 is a low quiescent current device with a nominal 4 M $\Omega$  pull-down resistor on its enable pin (EN). The package is a space-saving 1.0 mm  $\times$  1.5 mm, 6-ball WLCSP.

## APPLICATIONS INFORMATION

### CAPACITOR SELECTION

#### Output Capacitor

The ADP197 is designed for operation with small, space-saving ceramic capacitors but functions with most commonly used capacitors when the effective series resistance (ESR) value is carefully considered. The ESR of the output capacitor affects the response to load transients. A typical 1  $\mu\text{F}$  capacitor with an ESR of 0.1  $\Omega$  or less is recommended for good transient response. Using a larger value of output capacitance improves the transient response to large changes in load current.

#### Input Bypass Capacitor

Connecting at least 1  $\mu\text{F}$  of capacitance from  $V_{\text{IN}}$  to GND reduces the circuit sensitivity to the printed circuit board (PCB) layout, especially when high source impedance or long input traces are encountered. When greater than 1  $\mu\text{F}$  of output capacitance is required, increase the input capacitor to match it.

### GROUND CURRENT

The major source for ground current in the ADP197 is the internal charge pump for the FET drive circuitry. Figure 24 shows the typical ground current when  $V_{\text{EN}} = V_{\text{IN}}$ , and varies from 1.8 V to 5.5 V.

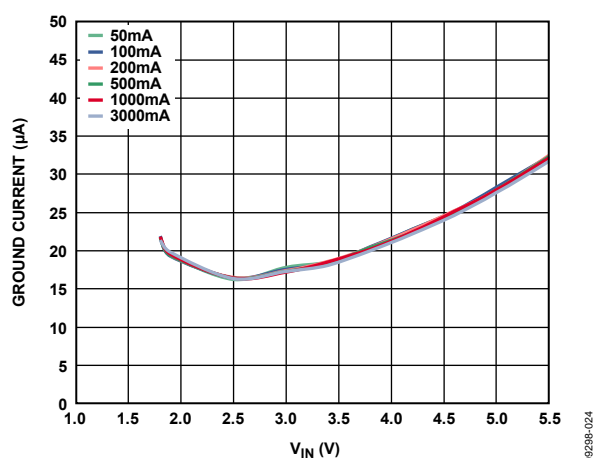

Figure 24. Ground Current vs. Load Current, Different Input Voltages ( $V_{\text{IN}}$ )

### ENABLE FEATURE

The ADP197 uses the EN pin to enable and disable the  $V_{\text{OUT}}$  pin under normal operating conditions. As shown in Figure 25, when a rising voltage ( $V_{\text{EN}}$ ) on the EN pin crosses the active threshold,  $V_{\text{OUT}}$  turns on. When a falling voltage ( $V_{\text{EN}}$ ) on the EN pin crosses the inactive threshold,  $V_{\text{OUT}}$  turns off.

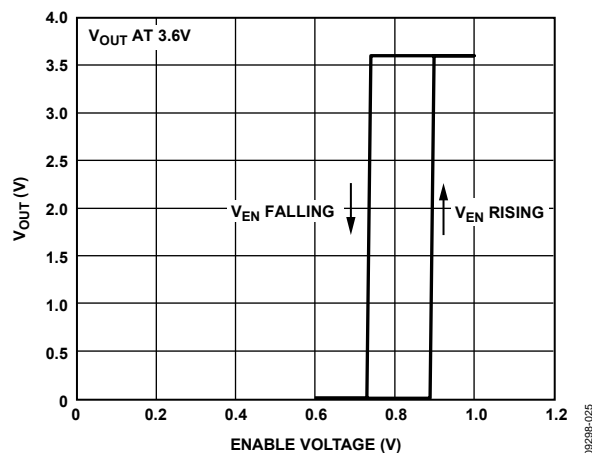

Figure 25. Typical EN Operation

As shown in Figure 25, the EN pin has hysteresis built into it. This prevents on/off oscillations that can occur due to noise on the EN pin as it passes through the threshold points.

The EN pin active/inactive thresholds derive from the  $V_{\text{IN}}$  voltage; therefore, these thresholds vary with the changing input voltage. Figure 26 shows the typical EN active/inactive thresholds when the input voltage varies from 1.8 V to 5.5 V.

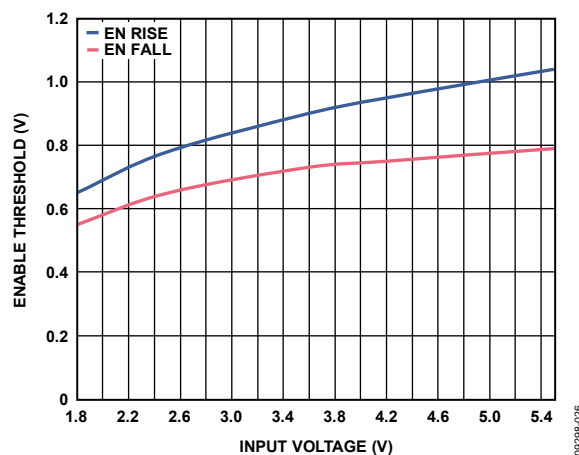

Figure 26. Typical EN Thresholds vs. Input Voltage ( $V_{\text{IN}}$ )

### TIMING

Turn-on delay is defined as the interval between the time that  $V_{\text{EN}}$  exceeds the rising threshold voltage and when  $V_{\text{OUT}}$  rises to  $\sim 10\%$  of its final value. The ADP197 includes circuitry that has a typical 1 ms turn-on delay and a controlled rise time to limit the  $V_{\text{IN}}$  inrush current. As shown in Figure 27 and Figure 28, the turn-on delay is nearly independent of the input voltage.

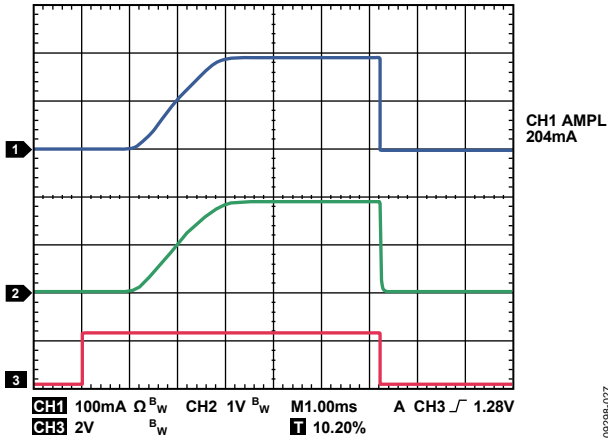

Figure 27. Typical Turn-On Delay Time with  $V_{IN} = 1.9\text{ V}$ ,  $I_{LOAD} = 200\text{ mA}$

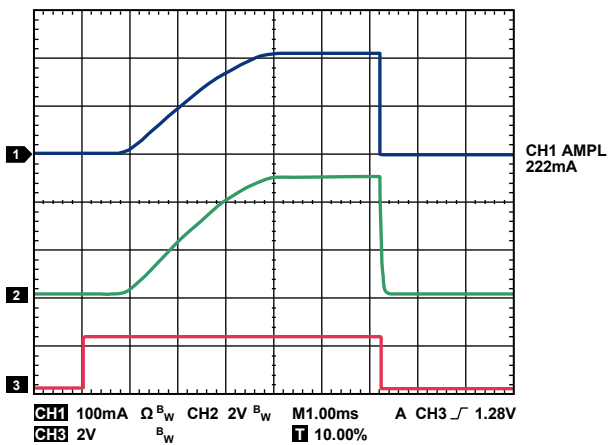

Figure 28. Typical Turn-On Delay Time with  $V_{IN} = 5.5\text{ V}$ ,  $I_{LOAD} = 220\text{ mA}$

The rise time is defined as the time it takes the output voltage to rise from 10% to 90% of  $V_{OUT}$  reaching its final value. It is dependent on the rise time of the internal charge pump.

For very large values of output capacitance, the RC time constant (where C is the load capacitance ( $C_{LOAD}$ ) and R is the  $R_{DS(ON)} || R_{LOAD}$ ) can become a factor in the rise time of the output voltage. Because  $R_{DS(ON)}$  is much smaller than  $R_{LOAD}$ , an adequate approximation for RC is  $R_{DS(ON)} \times C_{LOAD}$ . An input or load capacitor is not required for the ADP197 although capacitors can be used to suppress noise on the board.

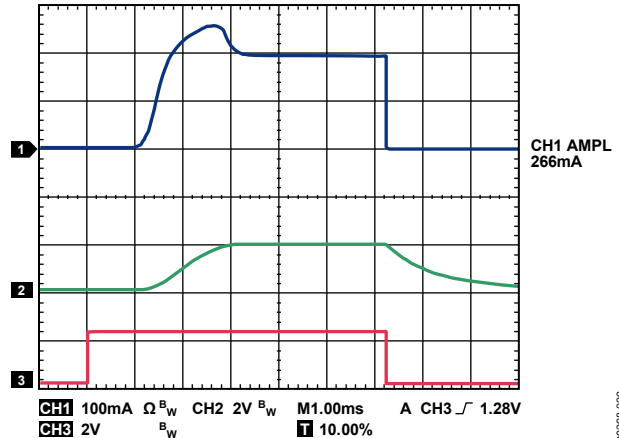

Figure 29. Typical Rise Time and Inrush Current,  $C_{LOAD} = 100\ \mu\text{F}$ ,  $V_{IN} = 1.9\text{ V}$ ,  $I_{LOAD} = 270\text{ mA}$

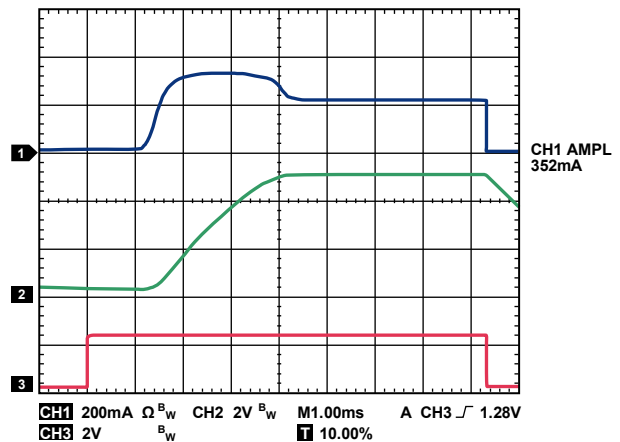

Figure 30. Typical Rise Time and Inrush Current,  $C_{LOAD} = 100\ \mu\text{F}$ ,  $V_{IN} = 5.5\text{ V}$ ,  $I_{LOAD} = 350\text{ mA}$

The turn-off time is defined as the time it takes for the output voltage to fall from 90% to 10% of  $V_{OUT}$  reaching its final value. It is also dependent on the RC time constant of the output capacitance and load resistance. Figure 31 shows the typical turn-off time with  $V_{IN} = 3.6\text{ V}$ ,  $C_{OUT} = 1\ \mu\text{F}$ , and  $R_{LOAD} = 18\ \Omega$ .

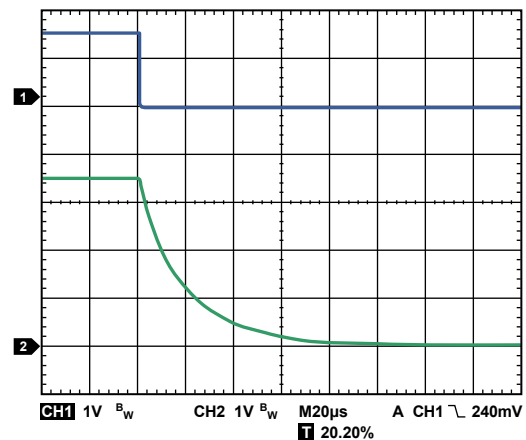
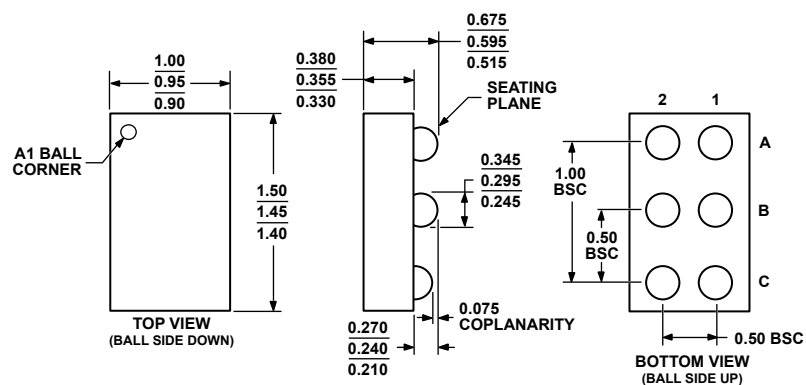

Figure 31. Typical Turn-Off Time

## OUTLINE DIMENSIONS



0816807-B

Figure 32. 6-Ball Wafer Level Chip Scale Package [WLCSP]  
(CB-6-2)  
Dimensions shown in millimeters

## ORDERING GUIDE

Model <sup>1</sup>	Temperature Range	Package Description	Package Option	Branding
ADP197ACBZ-R7	-40°C to +85°C	6-Ball Wafer Level Chip Scale Package [WLCSP]	CB-6-2	87
ADP197CB-EVALZ		Evaluation Board		

<sup>1</sup> Z = RoHS Compliant Part.

**ADP197**

**NOTES**

**NOTES**

**ADP197**

**NOTES**