

## SEALED TERMINAL AND WIRE LEAD OPTIONS OPTION -E AND -EW

### FEATURES

- 1/4, 1/2, and 1 Amp
- Limit, Overtravel, or Panel Seal
- Butt or Wiping Contact
- Normally Open or Normally Closed
- Momentary or Push/Pull
- Series 23, 30, 39 and 46



Option -E  
Epoxy-Sealed  
Terminals

Option -EW,  
Potted Base & 6"  
Wire Leads

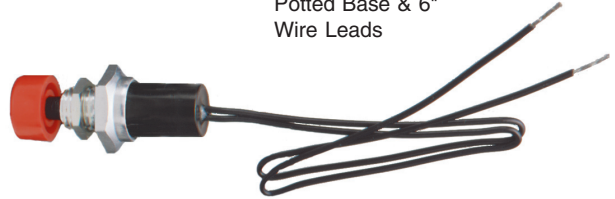

### SPECIFICATIONS

#### Rating Criteria

**Make and Break Current Rating:** See page for standard part number

**Contact Resistance:** 25 milliohms maximum on a new switch. Less than 4 milliohms per inch of wire for wire lead option styles.

**Insulation Resistance:** 1,000 megohms minimum between mutually insulated parts

**Voltage Breakdown:** 1,000 Vac minimum between mutually insulated parts

#### Materials and Finishes

**Potting Sleeve (Series 39):** Thermoset Plastic

**Wire Leads:** #26AWG, (.99mm diameter) insulated Teflon, Copper stranded wire, per MIL-W-16878, Type E. Ends are stripped 0.250" (6.35) and solder dipped. For other specifications, see Page References.

| Standard Part Number<br>Red Button | Standard Part Number<br>Black Button | Choices of<br>Suffix | Length Behind Panel<br>In inches (and millimeters) |                   |
|------------------------------------|--------------------------------------|----------------------|--|-------------------|
|                                    |                                      |                      | Standard Switch<br>& Terminals                     | -EW Style<br>Body |
| 23-1                               | 23-4                                 | -E                   | 0.665 (16,89)                                      | —                 |
| 30-1                               | 30-3                                 | -E, -EW              | 0.592 (15,04)                                      | 0.645 (16,38)     |
| 30-15                              | 30-37                                | -E, -EW              | 0.679 (17,25)                                      | 0.728 (18,49)     |
| 30-17 RED                          | 30-17 BLK                            | -E, -EW              | 0.958 (24,33)                                      | 1.007 (25,58)     |
| 30-16 RED                          | 30-16 BLK                            | -E, -EW              | 0.958 (24,33)                                      | 1.007 (25,58)     |
| 30-251 RED                         | 30-251 BLK                           | -E, -EW              | 0.632 (16,05)                                      | 0.685 (17,40)     |
| 30-252 RED                         | 30-252 BLK                           | -E, -EW              | 0.645 (16,38)                                      | 0.700 (17,78)     |
| 30-32 RED                          | 30-32 BLK                            | -E, -EW              | 0.867 (22,02)                                      | 0.896 (22,76)     |
| 30-6                               | 30-2                                 | -E, -EW              | 0.605 (15,37)                                      | 0.640 (16,26)     |
| 30-601 RED                         | 30-601 BLK                           | -E, -EW              | 0.592 (15,04)                                      | 0.645 (16,38)     |
| 39-1*                              | 39-3*                                | -EW**                | 0.315 (8,00)                                       | 0.440 (11,18)     |
| 39-12*                             | 39-2                                 | -E, -EW              | 0.490 (12,45)                                      | 0.575 (14,61)     |
| 39-101                             | 39-24*                               | -EW**                | 0.455 (11,56)                                      | 0.575 (14,61)     |
| 39-351 RED                         | 39-351 BLK                           | -EW**                | 0.650 (16,51)                                      | 0.775 (19,69)     |
| 39-352 RED*                        | 39-352 BLK*                          | -E, -EW              | 0.350 (8,89)                                       | 0.450 (11,43)     |
| 39-601 RED                         | 39-601 BLK                           | -E, -EW              | 0.529 (13,44)                                      | 0.630 (16,00)     |
| 39-701***                          | —                                    | -EW*                 | 0.315 (8,00)                                       | 0.440 (11,18)     |
| 39-702***                          | —                                    | -EW**                | 0.800 (20,32)                                      | 0.925 (23,50)     |
| 46-101 RED                         | 46-101 BLK                           | -E, -EW              | 0.510 (12,95)                                      | 0.750 (19,05)     |
| 46-102 RED                         | 46-102 BLK                           | -E, -EW              | 0.890 (22,61)                                      | 0.957 (24,31)     |
| 46-110 RED                         | 46-110 BLK                           | -E, -EW              | 0.890 (22,61)                                      | 0.957 (24,31)     |
| 46-111 RED                         | 46-111 BLK                           | -E, -EW              | 0.890 (22,61)                                      | 0.957 (24,31)     |
| 46-150 RED                         | 46-150 BLK                           | -E, -EW              | 0.890 (22,61)                                      | 0.957 (24,31)     |
| 46-151 RED                         | 46-151 BLK                           | -E, -EW              | 0.957 (24,31)                                      | 1.024 (26,01)     |
| 46-200 RED                         | 46-200 BLK                           | -E                   | 0.957 (24,31)                                      | 1.024 (26,01)     |
| 46-201 RED                         | 46-201 BLK                           | -E                   | 0.921 (23,39)                                      | —                 |
| 46-270 RED                         | 46-270 BLK                           | -E                   | 0.921 (23,39)                                      | —                 |
| 46-271 RED                         | 46-271 BLK                           | -E                   | 0.957 (24,31)                                      | —                 |
|                                    |                                      | -E                   | 0.957 (24,31)                                      | —                 |

\*Epoxy potting sleeve enlarges the diameter of the -EW style to 0.300 (7,62).

\*\*Sealed terminal (-E) option is not necessary; terminals have sealed construction.

\*\*\*Natural Color Button

†Adjustable from 1.214 (30,84) to 1.334 (33,88) dependent on button height, see switch pages.

**ORDERING INFORMATION**

Use the Selector Charts at the beginning of the section to select a series. Use the pages listed there or referenced here to select a switch.

To order epoxy sealed terminals, add the suffix -E to the selected part number as allowed in the chart. **Example:** 30-1-E.

To order the epoxy-potted version with 6-inch wire leads, use the suffix -EW as allowed in the chart. **Example:** 39-1-EW

**Available From Your Local Grayhill Distributors.** For prices and discounts, contact a local Sales Office, an authorized local Distributor or Grayhill.

**CIRCUITRY: Series 46**

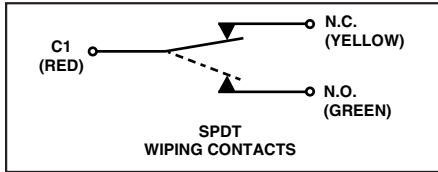

| Standard Part Number<br>Without Options<br>Choice of Button<br>Color<br>(see switch pages) | Standard<br>Part Number<br>Choice of<br>Button Color<br>(see switch pages) | Choices<br>of<br>Options | Length Behind Panel<br>In inches (and millimeters) |                   |
|--|--|--------------------------|--|-------------------|
|  |  |                          | Standard Switch<br>& Terminals                     | -EW Style<br>Body |
| —  | 30-001-A-XX  | -E, -EW                  | 1.119 (28,42)                                      | 1.172 (29,77)     |
| —  | 30-002-A-XX  | -E, -EW                  | 1.132 (28,75)                                      | 1.167 (29,64)     |
| —  | 30-015-A-XX  | -E, -EW                  | 1.204 (30,58)                                      | 1.253 (31,83)     |
| —  | 30-017-A-XX  | -E, -EW                  | Adjustable†  | Adjustable†       |
| 30-01-01-500-XX  | 30-1-1-50-XX   | -E, -EW                  | 1.100 (27,94)                                      | 1.153 (29,29)     |
| 30-01-04-500-XX  | 30-1-4-50-XX   | -E, -EW                  | 1.257 (31,93)                                      | 1.310 (33,27)     |
| 30-05-01-502-XX  | 30-5-1-52-XX   | -E, -EW                  | 0.930 (23,62)                                      | 0.983 (24,97)     |
| 30-05-04-502-XX  | 30-5-4-52-XX   | -E, -EW                  | 1.130 (28,70)                                      | 1.183 (30,05)     |
| —  | 30-601-A-XX  | -E, -EW                  | 1.119 (28,42)                                      | 1.172 (29,77)     |
| 46-01-05-500-XX  | 46-1-5-50-XX   | -E, -EW                  | 1.361 (34,57)                                      | 1.428 (36,27)     |
| 46-01-07-500-XX  | 46-1-7-50-XX   | -E, -EW                  | 1.451 (36,86)                                      | 1.518 (38,56)     |
| 46-01-08-500-XX  | 46-1-8-50-XX   | -E                       | 1.381 (35,08)                                      | —                 |
| 46-01-09-500-XX  | 46-1-9-50-XX   | -E                       | 1.381 (35,08)                                      | —                 |
| 46-05-05-502-XX  | 46-5-5-52-XX   | -E, -EW                  | 1.179 (29,95)                                      | 1.246 (31,65)     |
| 46-05-07-502-XX  | 46-5-7-52-XX   | -E, -EW                  | 1.465 (37,21)                                      | 1.532 (38,91)     |
| 46-05-08-502-XX  | 46-5-8-52-XX   | -E                       | 1.188 (30,18)                                      | —                 |
| 46-05-09-502-XX  | 46-5-9-52-XX   | -E                       | 1.317 (33,45)                                      | —                 |
| —  | 46-102-A-XX  | -E, -EW                  | 1.417 (35,99)                                      | 1.484 (37,69)     |
| —  | 46-111-A-XX  | -E, -EW                  | 1.417 (35,99)                                      | 1.484 (37,69)     |
| —  | 46-200-A-XX  | -E                       | 1.448 (36,78)                                      | —                 |
| —  | 46-201-A-XX  | -E                       | 1.448 (36,78)                                      | —                 |

\*Epoxy potting sleeve enlarges the diameter of the -EW style to 0.300 (7,62).  
 \*\*Sealed terminal (-E) option is not necessary; terminals have sealed construction.  
 \*\*\*Natural Color Button  
 †Adjustable from 1.214 (30,84) to 1.334 (33,88) dependent on button height, see switch pages.

Pushbutton Switches

## ACCESSORIES

### For Pushbutton Switches



Decorative Mounting Nuts



Button Caps

Button Guard



Pendant Housing

## DIMENSIONS In Inches (and millimeters)

### Decorative Mounting Nuts

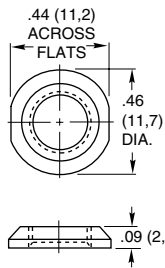

30C1023-1

Brass, nickel-plated for 1/4" (6,35) bushing.

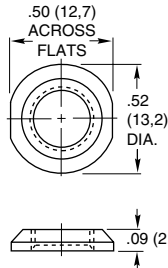

23C1024-1

Brass, nickel-plated for 5/16" (7,93) bushing.

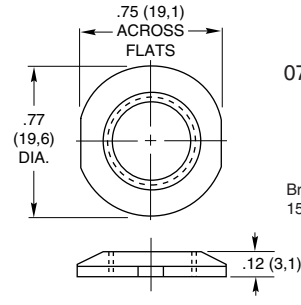

07C1040-1

Brass, nickel-plated for 15/32" (11,9) bushing.

### Button Caps and Guard

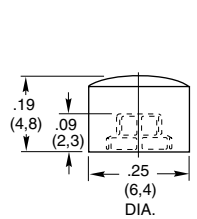

30B1012

Thermosetting plastic (Fasten to button with cyanoacrylate adhesive) black, red or white.

For use with all Series 30 and 39 switches except part number 39-101. See switch pages.

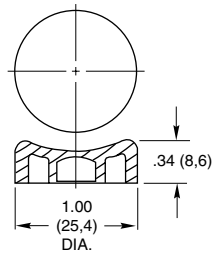

07Z1047

Thermoplastic, black or red color.

For use with Series 2000 and Series 7 switches. See switch pages.

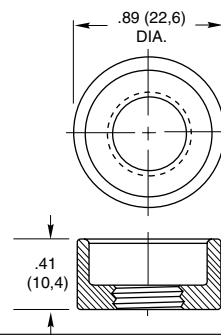

10C1015-1

Brass, zinc trivalent chromate-plated for 15/32" (11,9) bushing.

### Remote Switching Accessories Pendant Housing and Caps

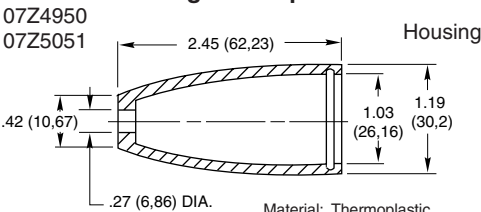

07Z4950  
07Z5051

Material: Thermoplastic  
Specials: other colors available on special order.

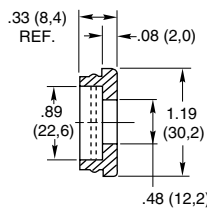

Flat Cap

Application:

All Grayhill pushbutton switches with 15/32-32 bushings: catalog numbers 2201, 2202, 07-7, 07-8, 07-21, 07-22, 07-26, 4001, 4002, 10-9, 10-10, 10-100, 10-101, 30-16, 30-17 and 30-32. any other switch with 15/32-32 bushing if it fits housing.

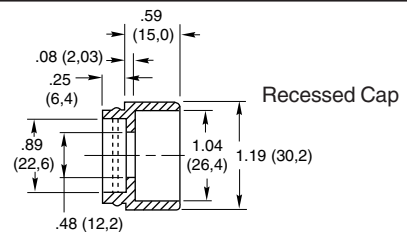

Recessed Cap

## ORDERING INFORMATION:

### Mounting Nuts, Button Caps, and Guards

| Part Number   | Color            |
|---------------|------------------|
| 07C1040-1     | Decorative Nut   |
| 23C1024       | Decorative Nut   |
| 30C1023-1     | Decorative Nut   |
| 07Z1047-1 BLK | Black Button Cap |
| 07Z1047-2 RED | Red Button Cap   |
| 10C1015-1     | Button Guard     |
| 30B1012-5     | Red Cap          |
| 30B1012-8     | White Cap        |
| 30B1012-9     | Black Cap        |

### Pendant Housing and Caps

| Part Number | Description               |
|-------------|---------------------------|
| 07Z4950 RED | Red Flat Cap & Housing    |
| 07Z4950 BLK | Black Flat Cap & Housing  |
| 07Z5051 RED | Red Rcstd Cap & Housing   |
| 07Z5051 BLK | Black Rcstd Cap & Housing |

Sold only as sets of one housing and one cap.

### Available from your local Grayhill Distributor.

For prices and discounts, contact a local Sales Office, an authorized local Distributor, or Grayhill.