

Cooper Bussmann

- Homepage
- About Cooper Bussmann
- Contact Us
- Privacy
- Legal
- Cooper Bussmann® Brand
- Site Map



ATM-3
Automotive blade-type Mini-Fuse

Product Information	
Product Type:	Fuse
Product Family:	Automotive
Brand:	Cooper Bussmann

Recommended Products	
Rec. Inline Fuse Holder:	HHM

Physical Properties	
Dimensions:	0.43in.(L) × 0.15in.(W) × 0.642in.(H)

Electrical Properties	
Maximum DC Voltage:	32
Amperage Rating:	3
DC Interrupting Ratings:	<ul style="list-style-type: none"> • 1000 at 32V
Fast Acting:	Yes

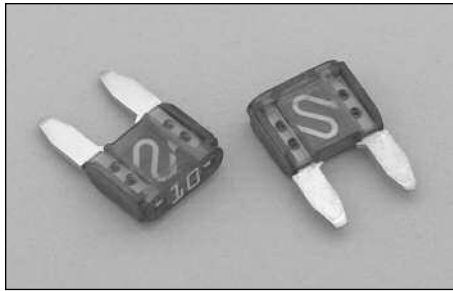

Dimensional Data

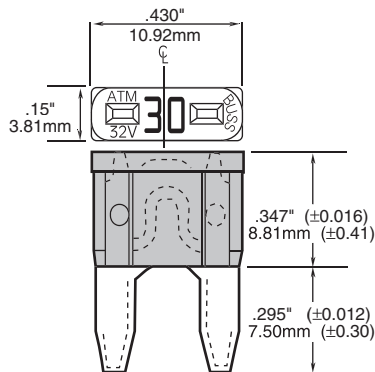

Catalog Symbol: ATM

Fast-Acting

Ampere Ratings: 2 to 30 Amperes

Interrupting Rating: 1,000 Amperes

Ordering: Specify packaging and product code

SPECIFICATIONS

Product Code	Body Color	Voltage Rating DC
ATM-2	Gray	32V
ATM-3	Violet	32V
ATM-4	Pink	32V
ATM-5	Tan	32V
ATM-7 1/2	Brown	32V
ATM-10	Red	32V
ATM-15	Lt. Blue	32V
ATM-20	Yellow	32V
ATM-25	Natural White	32V
ATM-30	Green	32V

Time-Current Characteristic Curves—Average Melt

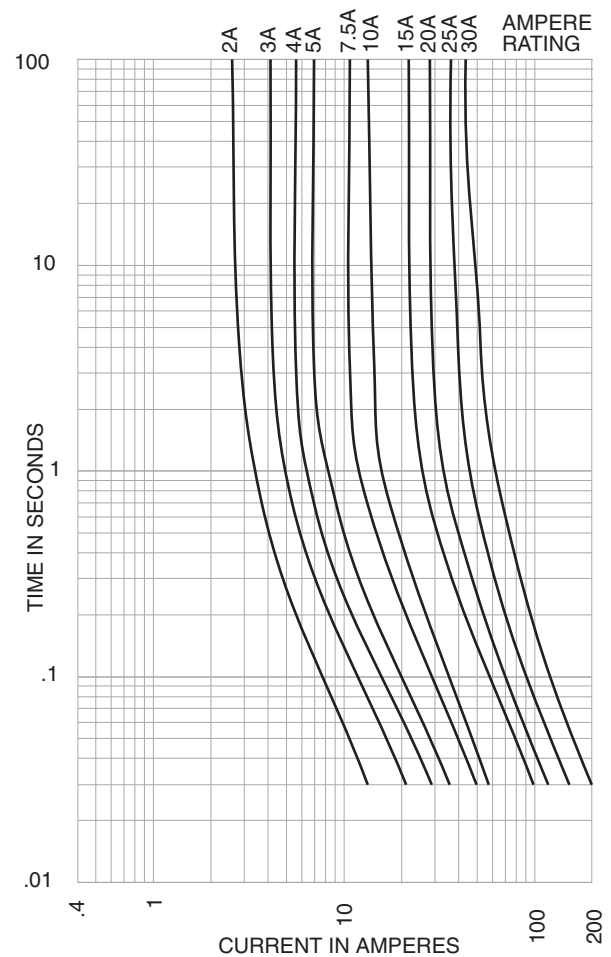

Recommended Bussmann Fuseholders

Blade-Type	Part	Description	Fuse Size	Wire Size
ATM	HHM	Fuseholder w/Cover	3-30 Amps	#12 Lead Wire; 4" Length
	HHM-B	Body Only		
	HHM-C	Cover Only	—	—
	HHL	Fuseholder w/Cover	2-20 Amps	#16 Lead Wire; 4" Length
	HHL-B	Body Only		

PACKAGING CODE

Packaging Code	Description
Blank	5 pieces of fuses packed in a tin
BK	500 pieces of fuses packed in a carton