

VPL10-5000

Electrical Specifications (@25C)

1. Maximum Power: 50.0VA
2. Input Voltage – Series: 230VAC @ 50/60Hz
Parallel: 115VAC @ 50/60Hz
3. Output Voltage – Series: 10.0V CT @ 5.00A
Parallel: 5.0V @ 10.0A
4. Voltage Regulation: 20% TYP @ full load to no load

Construction:

Dual bobbin construction with an insulated shroud, both made of a high temperature material that exceeds UL flammability requirements. Shrouds are provided over the connections of the leads to the windings on both primary and secondary coils. Devices are designed with a minimum of 6mm creepage distance between the primary and secondary.

Safety:

These units are designed with 3500VAC isolation between the primary and secondary, and also, between each winding and the core. Since the dual bobbin construction effectively reduces capacitance, electrostatic shielding is not required. International Series Transformers are designed and manufactured to meet most International Safety agency standards.

Devices are manufactured with a Class B (130° C) insulation system.

Dimensions: Units: In inches

A	B	C	D	E	F
2.562	4.00	2.250	3.562	8.00	.187

Weight: 2.3 lbs.

D. Mounting Holes: x 2

Schematic:

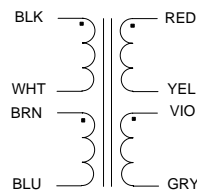

Input: Series – BLK to BLU, Jumper WHT to BRN
Parallel – BLK to WHT, Jumper BLK to BRN and WHT to BLU

Output: Series – RED to GRY, Jumper YEL to VIO
Parallel – RED to VIO, Jumper RED to VIO and YEL to GRY

Primary and secondary windings are designed to be connected in series or parallel. Windings are not intended to be used independently.

RoHS Compliance: As of manufacturing date February 2005, all standard products meet the requirements of 2002/95/EC, known as the RoHS initiative.

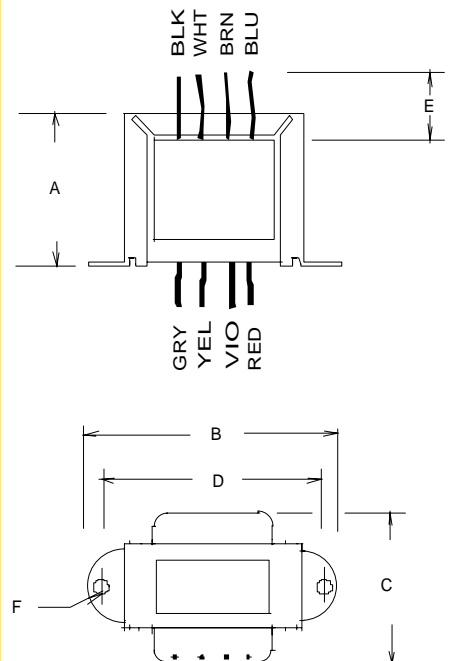

Power Transformers

Chassis Mount: Leaded World Series™

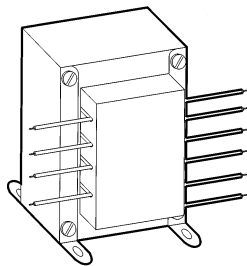

Case Type U

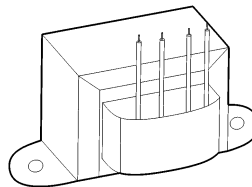

Case Type X

:: Description

Triad International Series transformers are constructed with European style split bobbins to meet International safety agency standards. The split bobbin construction reduces interwinding capacitance and eliminates the need for electrostatic shielding.

:: Specifications

Available in sizes from 5VA to 56 VA 115 V / 230 V 50/60 Hz Primary windings; 3,500 V isolation between primary and secondary; designed with 6mm creepage distance primary to secondary.

:: International Series

Secton	Part Number	VA	Secondary Series Connected		Secondary Parallel Connected		Center Tap	Schematic	Case Type	Dimensions			Mounting Dimensions		Weight Lbs.
			Volts	Amps	Volts	Amps				H	W	D	MW	MD	
A	VPL10-500	5	10.0	0.500	5.00	1.000	N	2	X	1 ¹ / ₁₆ "	2 ³ / ₈ "	1 ¹ / ₁₆ "	2	•	0.4
	VPL12-400	5	12.6	0.390	6.30	0.780	N	2	X	1 ¹ / ₁₆ "	2 ³ / ₈ "	1 ¹ / ₁₆ "	2	•	0.4
	VPL14-360	5	14.0	0.360	7.00	0.710	N	2	X	1 ¹ / ₁₆ "	2 ³ / ₈ "	1 ¹ / ₁₆ "	2	•	0.4
	VPL16-300	5	16.0	0.310	8.00	0.620	N	2	X	1 ¹ / ₁₆ "	2 ³ / ₈ "	1 ¹ / ₁₆ "	2	•	0.4
	VPL20-250	5	20.0	0.250	10.00	0.500	N	2	X	1 ¹ / ₁₆ "	2 ³ / ₈ "	1 ¹ / ₁₆ "	2	•	0.4
	VPL24-210	5	24.0	0.210	12.00	0.420	N	2	X	1 ¹ / ₁₆ "	2 ³ / ₈ "	1 ¹ / ₁₆ "	2	•	0.4
	VPL26-190	5	26.8	0.190	13.40	0.370	N	2	X	1 ¹ / ₁₆ "	2 ³ / ₈ "	1 ¹ / ₁₆ "	2	•	0.4
	VPL28-180	5	28.0	0.180	14.00	0.360	N	2	X	1 ¹ / ₁₆ "	2 ³ / ₈ "	1 ¹ / ₁₆ "	2	•	0.4
VPL36-140	5	36.0	0.140	18.00	0.280	N	2	X	1 ¹ / ₁₆ "	2 ³ / ₈ "	1 ¹ / ₁₆ "	2	•	0.4	
B	VPL2-4000	10	2.5	4.000	1.25	8.000	N	2	X	1 ³ / ₄ "	2 ¹ / ₁₆ "	1 ³ / ₄ "	2 ³ / ₈ "	•	0.7
	VPL10-1000	10	10.0	1.000	5.00	2.000	N	2	X	1 ³ / ₄ "	2 ¹ / ₁₆ "	1 ³ / ₄ "	2 ³ / ₈ "	•	0.7
	VPL12-800	10	12.6	0.790	6.30	1.590	N	1	X	1 ³ / ₄ "	2 ¹ / ₁₆ "	1 ³ / ₄ "	2 ³ / ₈ "	•	0.7
	VPL16-600	10	16.0	0.630	8.00	1.260	N	2	X	1 ³ / ₄ "	2 ¹ / ₁₆ "	1 ³ / ₄ "	2 ³ / ₈ "	•	0.7
	VPL20-500	10	20.0	0.500	10.00	1.000	N	2	X	1 ³ / ₄ "	2 ¹ / ₁₆ "	1 ³ / ₄ "	2 ³ / ₈ "	•	0.7
	VPL24-400	10	24.0	0.410	12.00	0.820	N	2	X	1 ³ / ₄ "	2 ¹ / ₁₆ "	1 ³ / ₄ "	2 ³ / ₈ "	•	0.7
	VPL28-350	10	28.0	0.350	14.00	0.700	N	2	X	1 ³ / ₄ "	2 ¹ / ₁₆ "	1 ³ / ₄ "	2 ³ / ₈ "	•	0.7
	VPL36-300	10	36.0	0.280	18.00	0.560	N	2	X	1 ³ / ₄ "	2 ¹ / ₁₆ "	1 ³ / ₄ "	2 ³ / ₈ "	•	0.7
C	VPL2-10000	25	2.5	10.000	1.25	20.000	N	2	X	1 ⁵ / ₁₆ "	3 ¹ / ₄ "	2 ¹ / ₈ "	2 ⁵ / ₁₆ "	•	1.3
	VPL10-2500	25	10.0	2.500	5.00	5.000	N	2	X	1 ⁵ / ₁₆ "	3 ¹ / ₄ "	2 ¹ / ₈ "	2 ⁵ / ₁₆ "	•	1.3
	VPL12-2000	25	12.6	1.980	6.30	3.960	Y	1	X	1 ⁵ / ₁₆ "	3 ¹ / ₄ "	2 ¹ / ₈ "	2 ⁵ / ₁₆ "	•	1.3
	VPL16-1600	25	16.0	1.570	8.00	3.130	N	2	X	1 ⁵ / ₁₆ "	3 ¹ / ₄ "	2 ¹ / ₈ "	2 ⁵ / ₁₆ "	•	1.3
	VPL20-1200	25	20.0	1.250	10.00	2.500	N	2	X	1 ⁵ / ₁₆ "	3 ¹ / ₄ "	2 ¹ / ₈ "	2 ⁵ / ₁₆ "	•	1.3
	VPL24-1100	25	24.0	1.040	12.00	2.080	N	2	X	1 ⁵ / ₁₆ "	3 ¹ / ₄ "	2 ¹ / ₈ "	2 ⁵ / ₁₆ "	•	1.3
	VPL25-1000	25	25.2	0.990	12.60	1.980	N	2	X	1 ⁵ / ₁₆ "	3 ¹ / ₄ "	2 ¹ / ₈ "	2 ⁵ / ₁₆ "	•	1.3
	VPL26-930	25	26.8	0.930	13.40	1.860	N	2	X	1 ⁵ / ₁₆ "	3 ¹ / ₄ "	2 ¹ / ₈ "	2 ⁵ / ₁₆ "	•	1.3
	VPL28-900	25	28.0	0.890	14.00	1.790	N	2	X	1 ⁵ / ₁₆ "	3 ¹ / ₄ "	2 ¹ / ₈ "	2 ⁵ / ₁₆ "	•	1.3
VPL36-700	25	36.0	0.700	18.00	1.400	N	2	X	1 ⁵ / ₁₆ "	3 ¹ / ₄ "	2 ¹ / ₈ "	2 ⁵ / ₁₆ "	•	1.3	
D	VPL10-5000	50	10.0	5.000	5.00	10.000	N	2	X	2 ¹ / ₁₆ "	4"	2 ¹ / ₄ "	3 ³ / ₁₆ "	•	2.3
	VPL12-4000	50	12.6	3.970	6.30	7.940	Y	1	X	2 ¹ / ₁₆ "	4"	2 ¹ / ₄ "	3 ³ / ₁₆ "	•	2.3
	VPL16-3100	50	16.0	3.125	8.00	6.250	N	2	X	2 ¹ / ₁₆ "	4"	2 ¹ / ₄ "	3 ³ / ₁₆ "	•	2.3
	VPL20-2500	50	20.0	2.500	10.00	5.000	N	2	X	2 ¹ / ₁₆ "	4"	2 ¹ / ₄ "	3 ³ / ₁₆ "	•	2.3
	VPL24-2000	50	24.0	2.083	12.00	4.166	N	2	X	2 ¹ / ₁₆ "	4"	2 ¹ / ₄ "	3 ³ / ₁₆ "	•	2.3
	VPL25-1900	50	25.2	1.984	•	•	N	3	X	2 ¹ / ₁₆ "	4"	2 ¹ / ₄ "	3 ³ / ₁₆ "	•	2.3
	VPL26-1800	50	26.8	1.866	•	•	N	3	X	2 ¹ / ₁₆ "	4"	2- ¹ / ₄ "	3 ³ / ₁₆ "	•	2.3
	VPL28-1700	50	28.0	1.786	14.00	3.572	N	2	X	2 ¹ / ₁₆ "	4"	2 ¹ / ₄ "	3 ³ / ₁₆ "	•	2.3
VPL36-1400	50	36.0	1.389	18.00	2.778	N	2	X	2 ¹ / ₁₆ "	4"	2 ¹ / ₄ "	3 ³ / ₁₆ "	•	2.3	
E	VPL28-2000	56	28.0	2.000	14.00	4.000	Y	1	U	3 ¹ / ₁₆ "	2 ¹ / ₁₆ "	2 ¹ / ₈ "	2"	2 ¹ / ₄ "	2.7

Technical Note: Primary and secondary windings are designed to be connected in Series or Parallel. Windings are not intended to be used independently.

:: Outline Dimensions

Technical Notes

1. Primary and secondary windings are designed to be connected in series or parallel. Windings are not intended to be used independently.

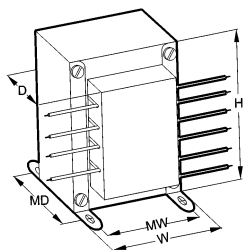

Case Type U

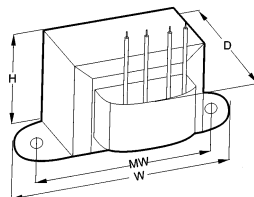

Case Type X

Schematic 1

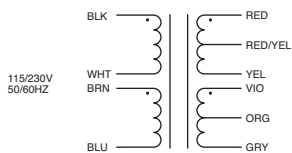

Schematic 2

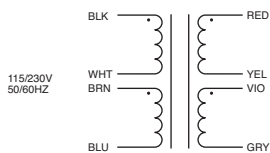

Schematic 3

