



CML INNOVATIVE TECHNOLOGIES
WHERE INNOVATION COMES TO LIGHT

Products

LED Indicators

CML IT offers panel mount indicators manufactured with LED, Neon or Incandescent light sources. These indicators are available in a number of different lens and termination styles, with voltages of 2V ~ 250V available off-the-shelf.

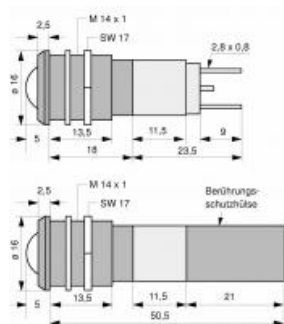

Part Number: 19350230
Serial Number: 1935
Mounting hole (inch): 0.5512"
Mounting hole (metric): 14mm
Indicator type: standard
Mounting type: with bezel
Bezel type: prominent
Bezel material: metal
Bezel color: satin chrome
Bezel size: M14
Protection: IP40
Lens type: round
Lens color: red diffused
Lens size: 10mm
Connector type: tab terminals 2.8x0.8
Connector number: 2
Connector for lamp test: no
Number LED chip: 1
Indicator color: red
Dom wave length: 640nm
Peak wave length (mA):
Op. voltage (V): 230V AC
Forward volt max:
Rectifier: Half Wave
AC current: 3mA
DC current: -
Lum in min (mcd):
Lum in type (DC): 18mcd
Voltage type (%): 10%
Op. temperature (°C): -25 °C - +60 °C
Storage temperature (°C): -25°C - +60°C
Narrative: with protection tube
Viewing angle (°):
RoHS Status: Yes

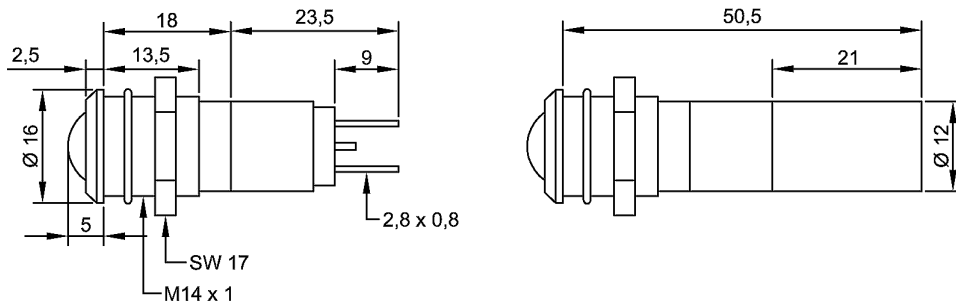

Alle Maße in mm / All dimensions are in mm

Elektrische und optische Daten sind bei einer Umgebungstemperatur von 25°C gemessen.
Electrical and optical data are measured at an ambient temperature of 25°C.

Bestell-Nr. Part No.	Farbe Colour	Spannung Voltage	Strom Current	Lichtstärke Lumi. Intensity
1935x230	Red	230V AC	3mA	18mcd
1935x231	Green	230V AC	3mA	11mcd
1935x233	Yellow	230V AC	3mA	8mcd
1935x235	Ultra-Green	230V AC	3mA	330mcd
1935x237	Blue	230V AC	3mA	98mcd
1935x23W	White	230V AC	3mA	165mcd

Lichtstärkedaten der verwendeten Leuchtdioden bei DC / Luminous intensity data of the used LEDs at DC

Lagertemperatur / Storage temperature -25°C - +80°C
Umgebungstemperatur / Ambient temperature -20°C - +60°C
Spannungstoleranz / Voltage tolerance +10%

Schutzart: IP67 nach DIN EN 60529 - Frontseitig zwischen LED und Gehäuse, sowie zwischen Gehäuse und Frontplatte bei Verwendung des mitgelieferten Dichtringes.
Degree of protection: IP67 in accordance to DIN EN 60529 - Gap between LED and bezel and gap between bezel and frontplate sealed to IP67 when using the supplied gasket.

x = 0 glanzverchromter Metallreflektor / satin chrome bezel
x = 1 schwarzverchromter Metallreflektor / black chrome bezel
x = 2 mattverchromter Metallreflektor / matt chrome bezel

Allgemeiner Hinweis: Bedingt durch die Fertigungstoleranzen der Leuchtdioden kann es zu geringfügigen Schwankungen der Farbe (Farbtemperatur) kommen. Es kann deshalb nicht ausgeschlossen werden, daß die Farben der Leuchtdioden eines Fertigungsloses unterschiedlich wahrgenommen werden.

General: Due to production tolerances, colour temperature variations may be detected within individual consignments.

Die Anzeigen mit Flachsteckeranschlüssen sind nicht für Lötanschluss geeignet / The indicators with tabconnection are not qualified for soldering.

Der Kunststoff (Polycarbonat) ist nur bedingt chemikalienbeständig / The plastic (polycarbonate) is limited resistant against chemicals.

Die Auswahl und der technisch richtige Einbau unserer Produkte, nach den entsprechenden Vorschriften (z.B. VDE 0100 und 0160), obliegen dem Anwender / The selection and technical correct installation of our products, conforming for the relevant standards (e.g. VDE 0100 and VDE 0160) is incumbent on the user.



CML Technologies GmbH & Co. KG

**LED Indicator 14mm
Standard Bezel with Protection Tube**

				Drawn: J.J.	Ch'd: D.L.	Date:
Revision:	Date:	Name:	Scale: 1 : 1	Datasheet: 1935x23x		