

MODEL PAX – 1/8 DIN ANALOG INPUT PANEL METERS



- PROCESS, VOLTAGE, CURRENT, TEMPERATURE, AND STRAIN GAGE INPUTS
- 5-DIGIT 0.56" RED SUNLIGHT READABLE DISPLAY
- VARIABLE INTENSITY DISPLAY
- 16 POINT SCALING FOR NON-LINEAR PROCESSES
- PROGRAMMABLE FUNCTION KEYS/USER INPUTS
- 9 DIGIT TOTALIZER (INTEGRATOR) WITH BATCHING
- OPTIONAL CUSTOM UNITS OVERLAY W/BACKLIGHT
- FOUR SETPOINT ALARM OUTPUTS (W/OPTION CARD)
- COMMUNICATION AND BUS CAPABILITIES (W/OPTION CARD)
- RETRANSMITTED ANALOG OUTPUT (W/OPTION CARD)
- PC SOFTWARE AVAILABLE FOR METER CONFIGURATION
- NEMA 4X/IP65 SEALED FRONT BEZEL

GENERAL DESCRIPTION

The PAX Analog Panel Meters offer many features and performance capabilities to suit a wide range of industrial applications. Available in five different models to handle various analog inputs, including DC Voltage/Current, AC Voltage/Current, Process, Temperature, and Strain Gage Inputs. Refer to pages 4 through 6 for the details on the specific models. The optional plug-in output cards allow the opportunity to configure the meter for present applications, while providing easy upgrades for future needs.

The meters employ a bright 0.56" LED display. The unit is available with a red sunlight readable or a standard green LED. The intensity of display can be adjusted from dark room applications up to sunlight readable, making it ideal for viewing in bright light applications.

The meters provide a MAX and MIN reading memory with programmable capture time. The capture time is used to prevent detection of false max or min readings which may occur during start-up or unusual process events.

The signal totalizer (integrator) can be used to compute a time-input product. This can be used to provide a readout of totalized flow, calculate service intervals of motors or pumps, etc. The totalizer can also accumulate batch weighing operations.

The meters have four setpoint outputs, implemented on Plug-in option cards. The Plug-in cards provide dual FORM-C relays (5A), quad FORM-A (3A), or either quad sinking or quad sourcing open collector logic outputs. The setpoint alarms can be configured to suit a variety of control and alarm requirements.

Communication and Bus Capabilities are also available as option cards. These include RS232, RS485, Modbus, DeviceNet, and Profibus-DP. Readout values and setpoint alarm values can be controlled through the bus. Additionally, the meters have a feature that allows a remote computer to directly control the outputs of the meter. With an RS232 or RS485 card installed, it is possible to configure the meter using a Windows® based program. The configuration data can be saved to a file for later recall.

A linear DC output signal is available as an optional Plug-in card. The card provides either 20 mA or 10 V signals. The output can be scaled independent of the input range and can track either the input, totalizer, max or min readings.

Once the meters have been initially configured, the parameter list may be locked out from further modification in its entirety or only the setpoint values can be made accessible.

The meters have been specifically designed for harsh industrial environments. With NEMA 4X/IP65 sealed bezel and extensive testing of noise effects to CE requirements, the meter provides a tough yet reliable application solution.

SAFETY SUMMARY

All safety related regulations, local codes and instructions that appear in this literature or on equipment must be observed to ensure personal safety and to prevent damage to either the instrument or equipment connected to it. If equipment is used in a manner not specified by the manufacturer, the protection provided by the equipment may be impaired.

Do not use this unit to directly command motors, valves, or other actuators not equipped with safeguards. To do so can be potentially harmful to persons or equipment in the event of a fault to the unit.



CAUTION: Read complete instructions prior to installation and operation of the unit.



CAUTION: Risk of electric shock.

DIMENSIONS In inches (mm)

Note: Recommended minimum clearance (behind the panel) for mounting clip installation is 2.1" (53.4) H x 5.0" (127) W.

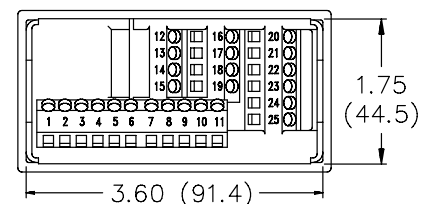
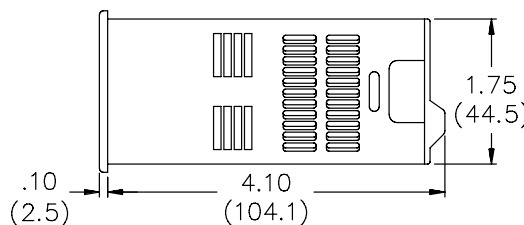
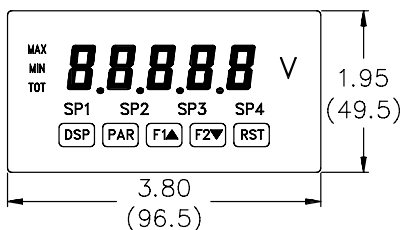
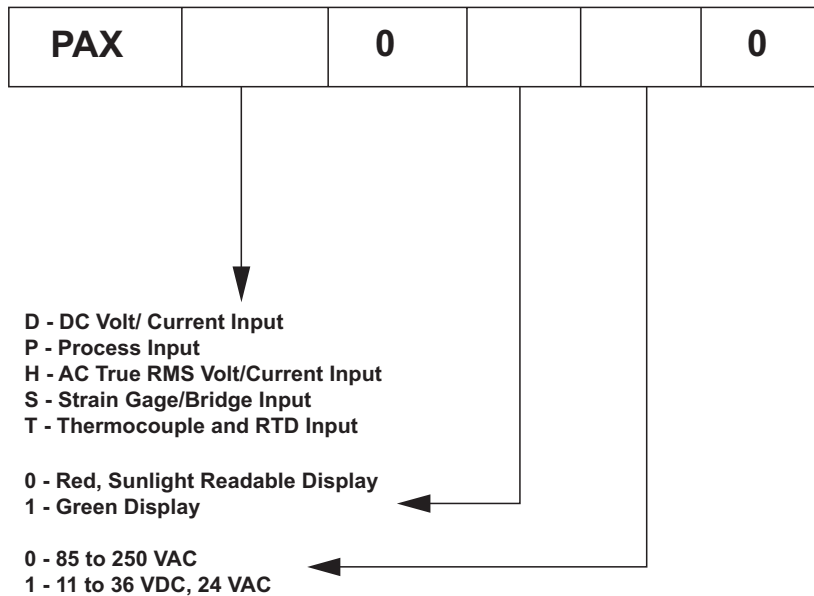

TABLE OF CONTENTS

Ordering Information	2	Installing the Meter	8
General Meter Specifications	3	Setting the Jumpers	8
Universal DC Input Panel Meter	4	Wiring the Meter	10
Process Input Panel Meter	4	Reviewing the Front Buttons and Display . .	13
AC True RMS Voltage and Current Meter . . .	5	Programming the Meter	14
Strain Gage Input Panel Meter	5	Factory Service Operations	23
Thermocouple and RTD Input Meter	6	Parameter Value Chart	25
Optional Plug-In Cards	7	Programming Overview	27

ORDERING INFORMATION

Meter Part Numbers



Option Card and Accessories Part Numbers

TYPE	MODEL NO.	DESCRIPTION	PART NUMBERS
Optional Plug-In Cards	PAXCDS	Dual Setpoint Relay Output Card	PAXCDS10
		Quad Setpoint Relay Output Card	PAXCDS20
		Quad Setpoint Sinking Open Collector Output Card	PAXCDS30
		Quad Setpoint Sourcing Open Collector Output Card	PAXCDS40
	PAXCDC	RS485 Serial Communications Output Card with Terminal Block	PAXCDC10
		Extended RS485 Serial Communications Output Card with Dual RJ11 Connector	PAXCDC1C
		RS232 Serial Communications Output Card with Terminal Block	PAXCDC20
		Extended RS232 Serial Communications Output Card with 9 Pin D Connector	PAXCDC2C
		DeviceNet Communications Card	PAXCDC30
		Modbus Communications Card	PAXCDC40
Extended Modbus Communications Card with Dual RJ11 Connector		PAXCDC4C	
Profibus-DP Communications Card	PAXCDC50		
PAXCDL	Analog Output Card	PAXCDL10	
Accessories	PAXLBK	Units Label Kit Accessory (Not required for PAXT)	PAXLBK10
	SFPAX*	PC Configuration Software for Windows 3.x and 95 (3.5" disk)	SFPAX

*Software can be downloaded from www.redlion.net

GENERAL METER SPECIFICATIONS

1. **DISPLAY:** 5 digit, 0.56" (14.2 mm) red sunlight readable or standard green LEDs, (-19999 to 99999)

2. **POWER:**

AC Versions:

AC Power: 85 to 250 VAC, 50/60 Hz, 15 VA

Isolation: 2300 Vrms for 1 min. to all inputs and outputs.

DC Versions (Not available on PAXH):

DC Power: 11 to 36 VDC, 11 W

(derate operating temperature to 40° C if operating <15 VDC and three plug-in option cards are installed)

AC Power: 24 VAC, ± 10%, 50/60 Hz, 15 VA

Isolation: 500 Vrms for 1 min. to all inputs and outputs (50 V working).

3. **ANNUNCIATORS:**

MAX - maximum readout selected

MIN - minimum readout selected

TOT - totalizer readout selected, flashes when total overflows

SP1 - setpoint alarm 1 is active

SP2 - setpoint alarm 2 is active

SP3 - setpoint alarm 3 is active

SP4 - setpoint alarm 4 is active

Units Label - optional units label backlight

4. **KEYPAD:** 3 programmable function keys, 5 keys total

5. **A/D CONVERTER:** 16 bit resolution

6. **UPDATE RATES:**

A/D conversion rate: 20 readings/sec.

Step response: 200 msec. max. to within 99% of final readout value

(digital filter and internal zero correction disabled)

700 msec. max. (digital filter disabled, internal zero correction enabled)

PAXH Only: 1 sec max. to within 99% of final readout value (digital filter disabled)

Display update rate: 1 to 20 updates/sec.

Setpoint output on/off delay time: 0 to 3275 sec.

Analog output update rate: 0 to 10 sec

Max./Min. capture delay time: 0 to 3275 sec.

7. **DISPLAY MESSAGES:**

“LOL” - Appears when measurement exceeds + signal range.

“ULUL” - Appears when measurement exceeds - signal range

PAXT: “SHrt” - Appears when shorted sensor is detected. (RTD only)

PAXT: “OPEN” - Appears when open sensor is detected.

“ . . . ” - Appears when display values exceed + display range.

“ - . . . ” - Appears when display values exceed - display range.

8. **INPUT CAPABILITIES:** See specific product specifications, pages 4-6

9. **EXCITATION POWER:** See specific product specifications, pages 4-6

10. **LOW FREQUENCY NOISE REJECTION:** (Does not apply to PAXH)

Normal Mode: > 60 dB @ 50 or 60 Hz ±1%, digital filter off

Common Mode: >100 dB, DC to 120 Hz

11. **USER INPUTS:** Three programmable user inputs

Max. Continuous Input: 30 VDC

Isolation To Sensor Input Common: Not isolated. (Not PAXH)

PAXH: Isolation to Sensor Input Common: 1400 Vrms for 1 min.

Working Voltage: 125 V

Response Time: 50 msec. max.

Logic State: Jumper selectable for sink/source logic

INPUT STATE	SINKING INPUTS 22 K Ω pull-up to +5 V	SOURCING INPUTS 22 K Ω pull-down
Active	V _{IN} < 0.9 VDC	V _{IN} > 3.6 VDC
Inactive	V _{IN} > 3.6 VDC	V _{IN} < 0.9 VDC

12. **TOTALIZER:**

Function:

Time Base: second, minute, hour, or day

Batch: Can accumulate (gate) input display from a user input

Time Accuracy: 0.01% typical

Decimal Point: 0 to 0.0000

Scale Factor: 0.001 to 65.000

Low Signal Cut-out: -19,999 to 99,999

Total: 9 digits, display alternates between high order and low order readouts

13. **CUSTOM LINEARIZATION:**

Data Point Pairs: Selectable from 2 to 16

Display Range: -19,999 to 99,999

Decimal Point: 0 to 0.0000

PAXT: Ice Point Compensation: user value (0.00 to 650.00 μ V/°C)

14. **MEMORY:** Nonvolatile E²PROM retains all programmable parameters and display values.

15. **ENVIRONMENTAL CONDITIONS:**

Operating Temperature Range: 0 to 50°C (0 to 45°C with all three plug-in cards installed)

Storage Temperature Range: -40 to 60°C

Operating and Storage Humidity: 0 to 85% max. RH non-condensing

Altitude: Up to 2000 meters

16. **CERTIFICATIONS AND COMPLIANCES:**

SAFETY

UL Recognized Component, File #E179259, UL3101-1, CSA C22.2 No. 1010-1

PAXT Only: File # E156876, UL873, CSA C22.2 No. 24

Recognized to U.S. and Canadian requirements under the Component Recognition Program of Underwriters Laboratories, Inc.

UL Listed, File # E137808, UL508, CSA C22.2 No. 14-M95

LISTED by Und. Lab. Inc. to U.S. and Canadian safety standards

Type 4X Enclosure rating (Face only), UL50

IECEE CB Scheme Test Certificate #US/7470A/UL

CB Scheme Test Report #03ME09282-08292003

Issued by Underwriters Laboratories, Inc.

IEC 1010-1, EN 61010-1: Safety requirements for electrical equipment for measurement, control, and laboratory use, Part I

IP65 Enclosure rating (Face only), IEC 529

IP20 Enclosure rating (Rear of unit), IEC 529

ELECTROMAGNETIC COMPATIBILITY

Immunity to EN 50082-2

Electrostatic discharge EN 61000-4-2 Level 2; 4 Kv contact

Level 3; 8 Kv air

Electromagnetic RF fields EN 61000-4-3 Level 3; 10 V/m¹

80 MHz - 1 GHz

Fast transients (burst) EN 61000-4-4 Level 4; 2 Kv I/O

Level 3; 2 Kv power

RF conducted interference EN 61000-4-6 Level 3; 10 V/rms

150 KHz - 80 MHz

Simulation of cordless telephones ENV 50204 Level 3; 10 V/m

900 MHz ±5 MHz

200 Hz, 50% duty cycle

Emissions to EN 50081-2

RF interference EN 55011 Enclosure class A

Power mains class A

Notes:

1. *Self-recoverable loss of performance during EMI disturbance at 10 V/m: Measurement input and/or analog output signal may deviate during EMI disturbance.*

For operation without loss of performance:

Unit is mounted in a metal enclosure (Buckeye SM7013-0 or equivalent)

I/O and power cables are routed in metal conduit connected to earth ground.

Refer to EMC Installation Guidelines section of the bulletin for additional information.

17. **CONNECTIONS:** High compression cage-clamp terminal block

Wire Strip Length: 0.3" (7.5 mm)

Wire Gage: 30-14 AWG copper wire

Torque: 4.5 inch-lbs (0.51 N-m) max.

18. **CONSTRUCTION:** This unit is rated for NEMA 4X/IP65 outdoor use.

IP20 Touch safe. Installation Category II, Pollution Degree 2. One piece bezel/case. Flame resistant. Synthetic rubber keypad. Panel gasket and mounting clip included.

19. **WEIGHT:** 10.4 oz. (295 g)

MODEL PAXD - UNIVERSAL DC INPUT

- FOUR VOLTAGE RANGES (300 VDC Max)
- FIVE CURRENT RANGES (2A DC Max)
- THREE RESISTANCE RANGES (10K Ohm Max)
- SELECTABLE 24 V, 2 V, 1.75 mA EXCITATION

PAXD SPECIFICATIONS

INPUT RANGES:

INPUT RANGE	ACCURACY* (18 to 28°C)	ACCURACY* (0 to 50°C)	IMPEDANCE/ COMPLIANCE	MAX CONTINUOUS OVERLOAD	RESOLUTION
±200 µADC	0.03% of reading +0.03 µA	0.12% of reading +0.04µA	1.11 Kohm	15 mA	10 nA
±2 mADC	0.03% of reading +0.3 µA	0.12% of reading +0.4 µA	111 ohm	50 mA	0.1 µA
±20 mADC	0.03% of reading +3µA	0.12% of reading +4 µA	11.1 ohm	150 mA	1 µA
±200 mADC	0.05% of reading +30 µA	0.15% of reading +40 µA	1.1 ohm	500 mA	10 µA
±2 ADC	0.5% of reading +0.3 mA	0.7% of reading +0.4 mA	0.1 ohm	3 A	0.1 mA
±200 mVDC	0.03% of reading +30 µV	0.12% of reading +40 µV	1.066 Mohm	100 V	10 µV
±2 VDC	0.03% of reading +0.3 mV	0.12% of reading +0.4 mV	1.066 Mohm	300 V	0.1 mV
±20 VDC	0.03% of reading +3 mV	0.12% of reading +4 mV	1.066 Mohm	300 V	1 mV
±300 VDC	0.05% of reading +30 mV	0.15% of reading +40 mV	1.066 Mohm	300 V	10 mV
100 ohm	0.05% of reading +30 Mohm	0.2% of reading +40 Mohm	0.175 V	30 V	0.01 ohm
1000 ohm	0.05% of reading +0.3 ohm	0.2% of reading +0.4 ohm	1.75 V	30 V	0.1 ohm
10 Kohm	0.05% of reading +1 ohm	0.2% of reading +1.5 ohm	17.5 V	30 V	1 ohm

* After 20 minute warm-up. Accuracy is specified in two ways: Accuracy over an 18 to 28°C and 10 to 75% RH environment; and accuracy over a 0 to 50°C and 0 to 85%RH (non-condensing environment). Accuracy over the 0 to 50°C range includes the temperature coefficient effect of the meter.

EXCITATION POWER:

Transmitter Power: 24 VDC, ±5%, regulated, 50 mA max.
Reference Voltage: 2 VDC, ± 2%

Compliance: 1 kohm load min. (2 mA max.)
Temperature coefficient: 40 ppm/°C max.

Reference Current: 1.75 mADC, ± 2%
Compliance: 10 kohm load max.

Temperature coefficient: 40 ppm/°C max.

MODEL PAXP - PROCESS INPUT

- DUAL RANGE INPUT (20 mA or 10 VDC)
- 24 VDC TRANSMITTER POWER

PAXP SPECIFICATIONS

SENSOR INPUTS:

INPUT (RANGE)	ACCURACY* (18 to 28°C)	ACCURACY* (0 to 50°C)	IMPEDANCE/ COMPLIANCE	MAX CONTINUOUS OVERLOAD	DISPLAY RESOLUTION
20 mA (-2 to 26 mA)	0.03% of reading +2 µA	0.12% of reading +3 µA	20 ohm	150 mA	1 µA
10 VDC (-1 to 13 VDC)	0.03% of reading +2 mV	0.12% of reading +3 mV	500 Kohm	300 V	1 mV

* After 20 minute warm-up. Accuracy is specified in two ways: Accuracy over an 18 to 28°C and 10 to 75% RH environment; and accuracy over a 0 to 50°C and 0 to 85%RH (non-condensing environment). Accuracy over the 0 to 50°C range includes the temperature coefficient effect of the meter.

EXCITATION POWER:

Transmitter Power: 24 VDC, ±5%, regulated, 50 mA max.

MODEL PAXH - AC TRUE RMS VOLT AND CURRENT

- FOUR VOLTAGE RANGES (300 VAC Max)
- FIVE CURRENT RANGES (5 A Max)
- ACCEPTS AC OR DC COUPLED INPUTS
- THREE WAY ISOLATION: POWER, INPUT AND OUTPUTS

PAXH SPECIFICATIONS

INPUT RANGES:

 Isolation To Option Card Commons and User Input Commons: 125 Vrms
Isolation To AC Power Terminals: 250 Vrms

INPUT RANGE	ACCURACY*	IMPEDANCE (60 Hz)	MAX CONTINUOUS OVERLOAD	MAX DC BLOCKING	RESOLUTION
200 mV	0.1% of reading +0.4 mV	686 Kohm	30 V	±10 V	0.01 mV
2 V	0.1% of reading +2 mV	686 Kohm	30 V	±50 V	0.1 mV
20 V	0.1% of reading +20 mV	686 Kohm	300 V	±300 V	1 mV
300 V	0.2% of reading +0.3 V	686 Kohm	300 V	±300 V***	0.1 V
200 µA	0.1% of reading +0.4 µA	1.11 Kohm	15 mA	±15 mA	0.01 µA
2 mA	0.1% of reading +2 µA	111 ohm	50 mA	±50 mA	0.1 µA
20 mA	0.1% of reading +20 µA	11.1 ohm	150 mA	±150 mA	1 µA
200 mA	0.1% of reading +0.2 mA	1.1 ohm	500 mA	±500 mA	10 µA
5 A	0.5% of reading +5 mA	0.02 ohm	7 A**	±7 A***	1 mA

*Conditions for accuracy specification:

- 20 minutes warmup
- 18-28°C temperature range, 10-75% RH non-condensing
- 50 Hz - 400 Hz sine wave input
- 1% to 100% of range
- Add 0.1% reading + 20 counts error over 0-50°C range
- Add 0.2% reading + 10 counts error for crest factors up to 3, add 1% reading up to 5
- Add 0.5% reading + 10 counts of DC component
- Add 1% reading + 20 counts error over 20 Hz to 10 KHz range

** Non-repetitive surge rating: 15 A for 5 seconds

*** Inputs are direct coupled to the input divider and shunts. Input signals with high DC component levels may reduce the usable range.

MAX CREST FACTOR (Vp/VRMS): 5 @ Full Scale Input

INPUT COUPLING: AC or AC and DC

INPUT CAPACITANCE: 10 pF

COMMON MODE VOLTAGE: 125 VAC working

COMMON MODE REJECTION: (DC to 60 Hz) 100 dB

MODEL PAXS - STRAIN GAGE INPUT

- LOAD CELL, PRESSURE AND TORQUE BRIDGE INPUTS
- DUAL RANGE INPUT: ±24 mV OR ±240 mV
- SELECTABLE 5 VDC OR 10 VDC BRIDGE EXCITATION
- PROGRAMMABLE AUTO-ZERO TRACKING

PAXS SPECIFICATIONS

SENSOR INPUTS:

INPUT RANGE	ACCURACY* (18 to 28°C)	ACCURACY* (0 to 50°C)	IMPEDANCE	MAX CONTINUOUS OVERLOAD	RESOLUTION
±24 mVDC	0.02% of reading +3 µV	0.07% of reading +4 µV	100 Mohm	30 V	1 µV
±240 mVDC	0.02% of reading +30 µV	0.07% of reading +40 µV	100 Mohm	30 V	10 µV

* After 20 minute warm-up. Accuracy is specified in two ways: Accuracy over an 18 to 28°C and 10 to 75% RH environment; and accuracy over a 0 to 50°C and 0 to 85% RH (non-condensing environment). Accuracy over the 0 to 50°C range includes the temperature coefficient effect of the meter.

CONNECTION TYPE: 4-wire bridge (differential)
2-wire (single-ended)

COMMON MODE RANGE (w.r.t. input common): 0 to +5 VDC
Rejection: 80 dB (DC to 120 Hz)

BRIDGE EXCITATION :

Jumper Selectable: 5 VDC @ 65 mA max., ±2%

10 VDC @ 125 mA max., ±2%

Temperature coefficient (ratio metric): 20 ppm/°C max.

MODEL PAXT - THERMOCOUPLE AND RTD INPUT

- THERMOCOUPLE AND RTD INPUTS
- CONFORMS TO ITS-90 STANDARDS
- CUSTOM SCALING FOR NON-STANDARD PROBES
- TIME-TEMPERATURE INTEGRATOR

PAXT SPECIFICATIONS

READOUT:

Resolution: Variable: 0.1, 0.2, 0.5, or 1, 2, or 5 degrees

Scale: F or C

Offset Range: -19,999 to 99,999 display units

THERMOCOUPLE INPUTS:

Input Impedance: 20 MΩ

Lead Resistance Effect: 0.03μV/ohm

Max. Continuous Overvoltage: 30 V

INPUT TYPE	RANGE	ACCURACY* (18 to 28°C)	ACCURACY* (0 to 50°C)	STANDARD	WIRE COLOR	
					ANSI	BS 1843
T	-200 to 400°C -270 to -200°C	1.2°C **	2.1°C	ITS-90	(+) blue (-) red	(+) white (-) blue
E	-200 to 871°C -270 to -200°C	1.0°C **	2.4°C	ITS-90	(+) purple (-) red	(+) brown (-) blue
J	-200 to 760°C	1.1°C	2.3°C	ITS-90	(+) white (-) red	(+) yellow (-) blue
K	-200 to 1372°C -270 to -200°C	1.3°C **	3.4°C	ITS-90	(+) yellow (-) red	(+) brown (-) blue
R	-50 to 1768°C	1.9°C	4.0°C	ITS-90	no standard	(+) white (-) blue
S	-50 to 1768°C	1.9°C	4.0°C	ITS-90	no standard	(+) white (-) blue
B	100 to 300°C 300 to 1820°C	3.9°C 2.8°C	5.7°C 4.4°C	ITS-90	no standard	no standard
N	-200 to 1300°C -270 to -200°C	1.3°C **	3.1°C	ITS-90	(+) orange (-) red	(+) orange (-) blue
C (W5/W26)	0 to 2315°C	1.9°C	6.1°C	ASTM E988-90***	no standard	no standard

*After 20 min. warm-up. Accuracy is specified in two ways: Accuracy over an 18 to 28°C and 15 to 75% RH environment; and Accuracy over a 0 to 50°C and 0 to 85% RH (non condensing) environment. Accuracy specified over the 0 to 50°C operating range includes meter tempco and ice point tracking effects. The specification includes the A/D conversion errors, linearization conformity, and thermocouple ice point compensation. Total system accuracy is the sum of meter and probe errors. Accuracy may be improved by field calibrating the meter readout at the temperature of interest.

** The accuracy over the interval -270 to -200°C is a function of temperature, ranging from 1°C at -200°C and degrading to 7°C at -270°C. Accuracy may be improved by field calibrating the meter readout at the temperature of interest.

*** These curves have been corrected to ITS-90.

RTD INPUTS:

Type: 3 or 4 wire, 2 wire can be compensated for lead wire resistance

Excitation current: 100 ohm range: 165 μA

10 ohm range: 2.6 mA

Lead resistance: 100 ohm range: 10 ohm/lead max.

10 ohm range: 3 ohms/lead max.

Max. continuous overload: 30 V

INPUT TYPE	RANGE	ACCURACY* (18 to 28°C)	ACCURACY* (0 to 50°C)	STANDARD ***
100 ohm Pt alpha = .00385	-200 to 850°C	0.4°C	1.6°C	IEC 751
100 ohm Pt alpha = .003919	-200 to 850°C	0.4°C	1.6°C	no official standard
120 ohm Nickel alpha = .00672	-80 to 260°C	0.2°C	0.5°C	no official standard
10 ohm Copper alpha = .00427	-100 to 260°C	0.4°C	0.9°C	no official standard

CUSTOM RANGE: Up to 16 data point pairs

Input range: -10 to 65 mV

0 to 400 ohms, high range

0 to 25 ohms, low range

Display range: -19999 to 99999

INPUT TYPE	RANGE	ACCURACY* (18 to 28°C)	ACCURACY* (0 to 50°C)
Custom mV range	-10 to 65mV (1 μV res.)	0.02% of reading + 4μV	0.12% of reading + 5μV
Custom 100 ohm range	0 to 400 Ω (10 MΩ res.)	0.02% of reading + 0.04 Ω	0.12% of reading + 0.05 Ω
Custom 10 ohm range	0 to 25 Ω (1 MΩ res.)	0.04% of reading + 0.005 Ω	0.20% of reading + 0.007 Ω

ACCESSORIES

UNITS LABEL KIT (PAXLBK) - Not required for PAXT

Each meter has a units indicator with backlighting that can be customized using the Units Label Kit. The backlight is controlled in the programming.

Each PAXT meter is shipped with °F and °C overlay labels which can be installed into the meter's bezel display assembly.

EXTERNAL CURRENT SHUNTS (APSCM)

To measure DC current signals greater than 2 ADC, a shunt must be used. The APSCM010 current shunt converts a maximum 10 ADC signal into 10.0 mV. The APSCM100 current shunt converts a maximum 100 ADC signal into 100.0 mV. The continuous current through the shunt is limited to 115% of the rating.

OPTIONAL PLUG-IN OUTPUT CARDS



WARNING: Disconnect all power to the unit before installing Plug-in cards.

Adding Option Cards

The PAX and MPAX series meters can be fitted with up to three optional plug-in cards. The details for each plug-in card can be reviewed in the specification section below. Only one card from each function type can be installed at one time. The function types include Setpoint Alarms (PAXCDS), Communications (PAXCDC), and Analog Output (PAXCDL). The plug-in cards can be installed initially or at a later date.

PAXH Isolation Specifications For All Option Cards

Isolation To Sensor Commons: 1400 Vrms for 1 min.

Working Voltage: 125 V

Isolation to User Input Commons: 500 Vrms for 1 min.

Working Voltage 50 V

COMMUNICATION CARDS (PAXCDC)

A variety of communication protocols are available for the PAX and MPAX series. Only one of these cards can be installed at a time. When programming the unit via RLCPro, a Windows® based program, the RS232 or RS485 Cards must be used.

PAXCDC10 - RS485 Serial

PAXCDC40 - Modbus

PAXCDC20 - RS232 Serial

PAXCDC50 - Profibus-DP

PAXCDC30 - DeviceNet

SERIAL COMMUNICATIONS CARD

Type: RS485 or RS232

Isolation To Sensor & User Input Commons: 500 Vrms for 1 min.

Working Voltage: 50 V. Not Isolated from all other commons.

Data: 7/8 bits

Baud: 300 to 19,200

Parity: no, odd or even

Bus Address: Selectable 0 to 99, Max. 32 meters per line (RS485)

Transmit Delay: Selectable for 2 to 50 msec or 50 to 100 msec (RS485)

DEVICENET™ CARD

Compatibility: Group 2 Server Only, not UCMM capable

Baud Rates: 125 Kbaud, 250 Kbaud, and 500 Kbaud

Bus Interface: Phillips 82C250 or equivalent with MIS wiring protection per DeviceNet™ Volume I Section 10.2.2.

Node Isolation: Bus powered, isolated node

Host Isolation: 500 Vrms for 1 minute (50 V working) between DeviceNet™ and meter input common.

MODBUS CARD

Type: RS485; RTU and ASCII MODBUS modes

Isolation To Sensor & User Input Commons: 500 Vrms for 1 minute.

Working Voltage: 50 V. Not isolated from all other commons.

Baud Rates: 300 to 38400.

Data: 7/8 bits

Parity: No, Odd, or Even

Addresses: 1 to 247.

Transmit Delay: Programmable; See Transmit Delay explanation.

PROFIBUS-DP CARD

Fieldbus Type: Profibus-DP as per EN 50170, implemented with Siemens SPC3 ASIC

Conformance: PNO Certified Profibus-DP Slave Device

Baud Rates: Automatic baud rate detection in the range 9.6 Kbaud to 12 Mbaud

Station Address: 0 to 126, set by the master over the network. Address stored in non-volatile memory.

Connection: 9-pin Female D-Sub connector

Network Isolation: 500 Vrms for 1 minute (50 V working) between Profibus network and sensor and user input commons. Not isolated from all other commons.

PROGRAMMING SOFTWARE

The SFPAX is a Windows® based program that allows configuration of the PAX meter from a PC. Using the SFPAX makes it easier to program the PAX meter and allows saving the PAX program in a PC file for future use. On-line help is available within the software. A PAX serial plug-in card is required to program the meter using the software.

SETPOINT CARDS (PAXCDS)

The PAX and MPAX series has 4 available setpoint alarm output plug-in cards. Only one of these cards can be installed at a time. (Logic state of the outputs can be reversed in the programming.) These plug-in cards include:

PAXCDS10 - Dual Relay, FORM-C, Normally open & closed

PAXCDS20 - Quad Relay, FORM-A, Normally open only

PAXCDS30 - Isolated quad sinking NPN open collector

PAXCDS40 - Isolated quad sourcing PNP open collector

DUAL RELAY CARD

Type: Two FORM-C relays

Isolation To Sensor & User Input Commons: 2000 Vrms for 1 min.

Working Voltage: 240 Vrms

Contact Rating:

One Relay Energized: 5 amps @ 120/240 VAC or 28 VDC (resistive load), 1/8 HP @120 VAC, inductive load

Total current with both relays energized not to exceed 5 amps

Life Expectancy: 100 K cycles min. at full load rating. External RC snubber extends relay life for operation with inductive loads

QUAD RELAY CARD

Type: Four FORM-A relays

Isolation To Sensor & User Input Commons: 2300 Vrms for 1 min.

Working Voltage: 250 Vrms

Contact Rating:

One Relay Energized: 3 amps @ 240 VAC or 30 VDC (resistive load), 1/10 HP @120 VAC, inductive load

Total current with all four relays energized not to exceed 4 amps

Life Expectancy: 100K cycles min. at full load rating. External RC snubber extends relay life for operation with inductive loads

QUAD SINKING OPEN COLLECTOR CARD

Type: Four isolated sinking NPN transistors.

Isolation To Sensor & User Input Commons: 500 Vrms for 1 min.

Working Voltage: 50 V. Not Isolated from all other commons.

Rating: 100 mA max @ $V_{SAT} = 0.7 V$ max. $V_{MAX} = 30 V$

QUAD SOURCING OPEN COLLECTOR CARD

Type: Four isolated sourcing PNP transistors.

Isolation To Sensor & User Input Commons: 500 Vrms for 1 min.

Working Voltage: 50 V. Not Isolated from all other commons.

Rating: Internal supply: 24 VDC $\pm 10\%$, 30 mA max. total

External supply: 30 VDC max., 100 mA max. each output

ALL FOUR SETPOINT CARDS

Response Time: 200 msec. max. to within 99% of final readout value (digital filter and internal zero correction disabled)

700 msec. max. (digital filter disabled, internal zero correction enabled)

LINEAR DC OUTPUT (PAXCDL)

Either a 0(4)-20 mA or 0-10 V retransmitted linear DC output is available from the analog output plug-in card. The programmable output low and high scaling can be based on various display values. Reverse slope output is possible by reversing the scaling point positions.

PAXCDL10 - Retransmitted Analog Output Card

ANALOG OUTPUT CARD

Types: 0 to 20 mA, 4 to 20 mA or 0 to 10 VDC

Isolation To Sensor & User Input Commons: 500 Vrms for 1 min.

Working Voltage: 50 V. Not Isolated from all other commons.

Accuracy: 0.17% of FS (18 to 28°C); 0.4% of FS (0 to 50°C)

Resolution: 1/3500

Compliance: 10 VDC: 10 K Ω load min., 20 mA: 500 Ω load max.

Update time: 200 msec. max. to within 99% of final output value (digital filter and internal zero correction disabled)

700 msec. max. (digital filter disabled, internal zero correction enabled)

1.0 INSTALLING THE METER

Installation

The PAX meets NEMA 4X/IP65 requirements when properly installed. The unit is intended to be mounted into an enclosed panel. Prepare the panel cutout to the dimensions shown. Remove the panel latch from the unit. Slide the panel gasket over the rear of the unit to the back of the bezel. The unit should be installed fully assembled. Insert the unit into the panel cutout.

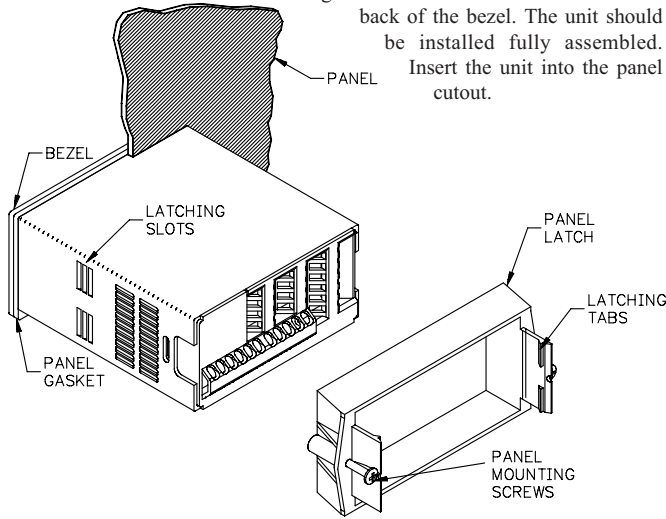

While holding the unit in place, push the panel latch over the rear of the unit so that the tabs of the panel latch engage in the slots on the case. The panel latch should be engaged in the farthest forward slot possible. To achieve a proper seal, tighten the latch screws evenly until the unit is snug in the panel (Torque to approximately 7 in-lbs [79N-cm]). Do not over-tighten the screws.

Installation Environment

The unit should be installed in a location that does not exceed the maximum operating temperature and provides good air circulation. Placing the unit near devices that generate excessive heat should be avoided.

The bezel should be cleaned only with a soft cloth and neutral soap product. Do NOT use solvents. Continuous exposure to direct sunlight may accelerate the aging process of the bezel.

Do not use tools of any kind (screwdrivers, pens, pencils, etc.) to operate the keypad of the unit.

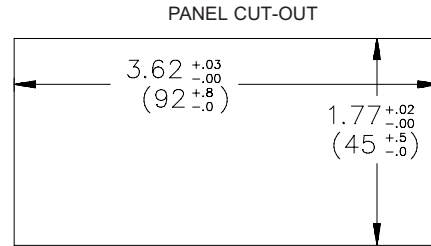

2.0 SETTING THE JUMPERS

The meter can have up to four jumpers that must be checked and / or changed prior to applying power. The following Jumper Selection Figures show an enlargement of the jumper area.

To access the jumpers, remove the meter base from the case by firmly squeezing and pulling back on the side rear finger tabs. This should lower the latch below the case slot (which is located just in front of the finger tabs). It is recommended to release the latch on one side, then start the other side latch.

Input Range Jumper

This jumper is used to select the proper input range. The input range selected in programming must match the jumper setting. Select a range that is high enough to accommodate the maximum input to avoid overloads. The selection is different for each meter. See the Jumper Selection Figure for appropriate meter.

Excitation Output Jumper

If your meter has excitation, this jumper is used to select the excitation range for the application. If excitation is not being used, it is not necessary to check or move this jumper.

User Input Logic Jumper

This jumper selects the logic state of all the user inputs. If the user inputs are not used, it is not necessary to check or move this jumper.

PAXH: Signal Jumper

This jumper is used to select the signal type. For current signals, the jumper is installed. For voltage signals, remove the jumper from the board. (For 2 V inputs, this removed jumper can be used in the "2 V only" location.)

Couple Jumper

This jumper is used for AC / DC couple. If AC couple, then the jumper is removed from the board. If DC couple is used, then the jumper is installed.

PAXD Jumper Selection

Input Range Jumper

One jumper is used for voltage/ohms or current input ranges. Select the proper input range high enough to avoid input signal overload. **Only one jumper is allowed in this area.** Do not have a jumper in both the voltage and current ranges at the same time. Avoid placing the jumper across two ranges.

JUMPER SELECTIONS

The indicates factory setting.

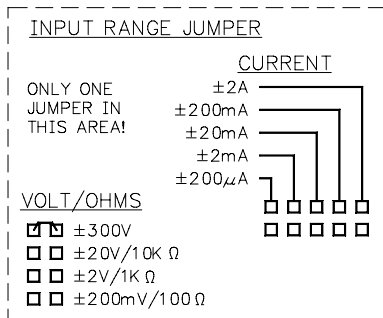

↓ REAR TERMINALS ↓

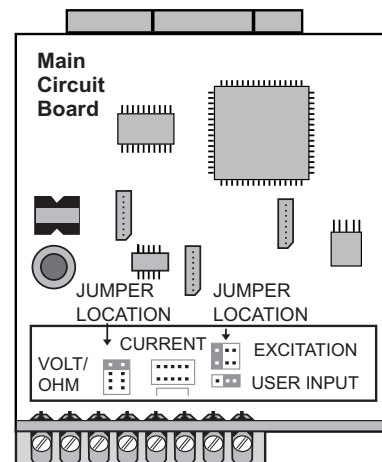
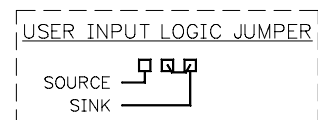
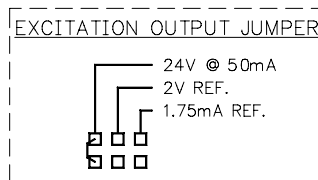

PAXP Jumper Selection

JUMPER SELECTIONS

The \square indicates factory setting.

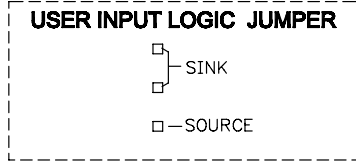

↓ REAR TERMINALS ↓

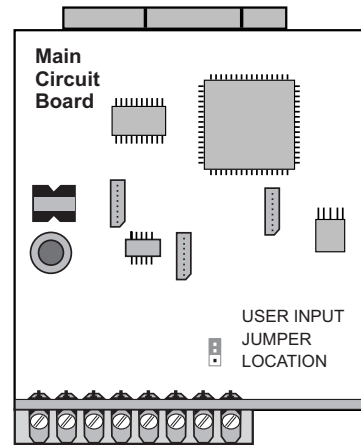

PAXH Jumper Selection



CAUTION: To maintain the electrical safety of the meter, remove unneeded jumpers completely from the meter. Do not move the jumpers to positions other than those specified.

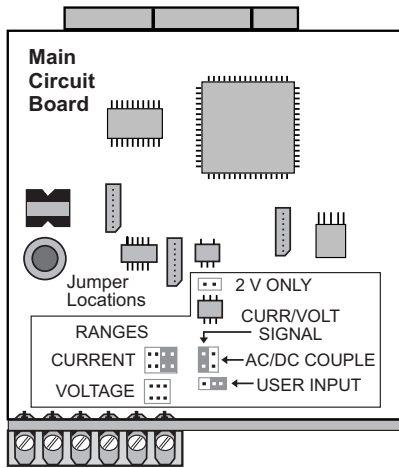

JUMPER SELECTIONS

The \square indicates factory setting.

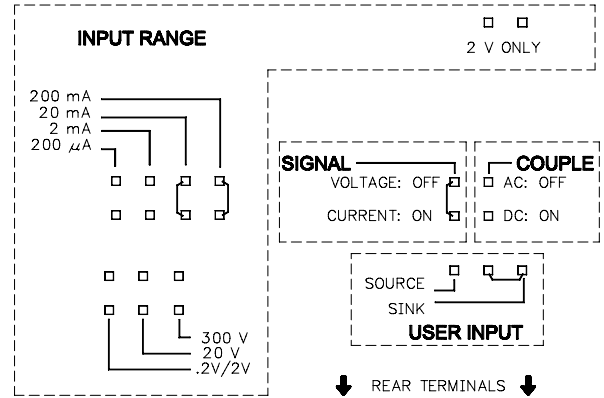

Signal Jumper

One jumper is used for the input signal type. For current signals, the jumper is installed. For voltage signals, remove the jumper from the board. (For 2 V inputs, this removed jumper can be used in the “2 V only” location.)

Couple Jumper

One jumper is used for AC / DC couple. If AC couple is used, then the jumper is removed from the board. If DC couple is used, then the jumper is installed.

Input Range Jumper

For most inputs, one jumper is used to select the input range. However, for the following ranges, set the jumpers as stated:

5 A: Remove all jumpers from the input range.

2 V: Install one jumper in “.2/2V” position and one jumper in “2 V only”.

All Other Ranges: One jumper in the selected range only.

Do not have a jumper in both the voltage and current ranges at the same time. Avoid placing a jumper across two ranges.

PAXS Jumper Selection

Bridge Excitation

One jumper is used to select bridge excitation to allow use of the higher sensitivity 24 mV input range. Use the 5 V excitation with high output (3 mV/V) bridges. The 5 V excitation also reduces bridge power compared to 10 V excitation.

A maximum of four 350 ohm load cells can be driven by the internal bridge excitation voltage.

JUMPER SELECTIONS

The \square indicates factory setting.

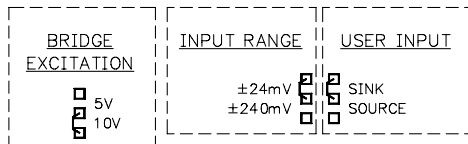

↓ REAR TERMINALS ↓

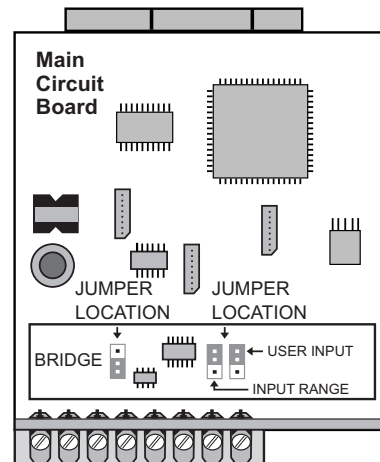

PAXT Jumper Selection

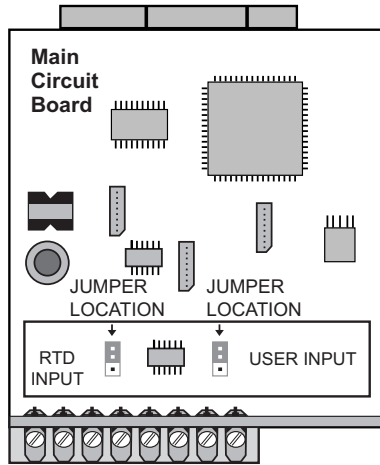

RTD Input Jumper

One jumper is used for RTD input ranges. Select the proper range to match the RTD probe being used. It is not necessary to remove this jumper when not using RTD probes.

JUMPER SELECTIONS

The \square indicates factory setting.

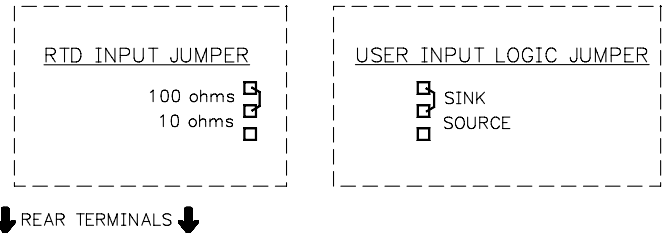

3.0 WIRING THE METER

WIRING OVERVIEW

Electrical connections are made via screw-clamp terminals located on the back of the meter. All conductors should conform to the meter's voltage and current ratings. All cabling should conform to appropriate standards of good installation, local codes and regulations. It is recommended that power supplied to the meter (DC or AC) be protected by a fuse or circuit breaker.

When wiring the meter, compare the numbers embossed on the back of the meter case against those shown in wiring drawings for proper wire position. Strip the wire, leaving approximately 0.3" (7.5 mm) bare lead exposed (stranded wires should be tinned with solder). Insert the lead under the correct screw-clamp terminal and tighten until the wire is secure. (Pull wire to verify tightness.) Each terminal can accept up to one #14 AWG (2.55 mm) wire, two #18 AWG (1.02 mm), or four #20 AWG (0.61 mm).

EMC INSTALLATION GUIDELINES

Although this meter is designed with a high degree of immunity to Electro-Magnetic Interference (EMI), proper installation and wiring methods must be followed to ensure compatibility in each application. The type of the electrical noise, its source or the method of coupling into the unit may be different for various installations. Listed below are some EMC guidelines for successful installation in an industrial environment.

1. The meter should be mounted in a metal enclosure, which is properly connected to protective earth.
2. With use of the lower input ranges or signal sources with high source impedance, the use of shielded cable may be necessary. This helps to guard against stray AC pick-up. Attach the shield to the input common of the meter. Line voltage monitoring and 5A CT applications do not usually require shielding.
3. To minimize potential noise problems, power the meter from the same power branch, or at least the same phase voltage as that of the signal source.

4. Never run Signal or Control cables in the same conduit or raceway with AC power lines, conductors feeding motors, solenoids, SCR controls, and heaters, etc. The cables should be run in metal conduit that is properly grounded. This is especially useful in applications where cable runs are long and portable two-way radios are used in close proximity or if the installation is near a commercial radio transmitter.
5. Signal or Control cables within an enclosure should be routed as far away as possible from contactors, control relays, transformers, and other noisy components.
6. In extremely high EMI environments, the use of external EMI suppression devices, such as ferrite suppression cores, is effective. Install them on Signal and Control cables as close to the unit as possible. Loop the cable through the core several times or use multiple cores on each cable for additional protection. Install line filters on the power input cable to the unit to suppress power line interference. Install them near the power entry point of the enclosure. The following EMI suppression devices (or equivalent) are recommended:

Ferrite Suppression Cores for signal and control cables:

Fair-Rite # 0443167251 (RLC #FCOR0000)

TDK # ZCAT3035-1330A

Steward #28B2029-0A0

Line Filters for input power cables:

Schaffner # FN610-1/07 (RLC #LFIL0000)

Schaffner # FN670-1.8/07

Corcom #1VR3

Note: Reference manufacturer's instructions when installing a line filter.

7. Long cable runs are more susceptible to EMI pickup than short cable runs. Therefore, keep cable runs as short as possible.
8. Switching of inductive loads produces high EMI. Use of snubbers across inductive loads suppresses EMI.
Snubber: RLC#SNUB0000.

3.1 POWER WIRING

AC Power

Terminal 1: VAC
Terminal 2: VAC

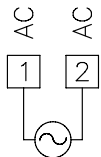

DC Power

Terminal 1: +VDC
Terminal 2: -VDC

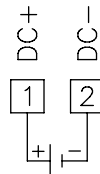

3.2 INPUT SIGNAL WIRING

PAXD INPUT SIGNAL WIRING

Before connecting signal wires, the Input Range Jumper and Excitation Jumper should be verified for proper position.

Voltage Signal (self powered)

Terminal 3: +VDC
Terminal 5: -VDC

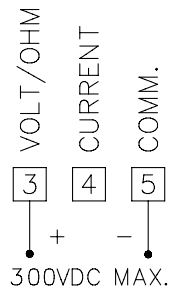

Current Signal (self powered)

Terminal 4: +ADC
Terminal 5: -ADC

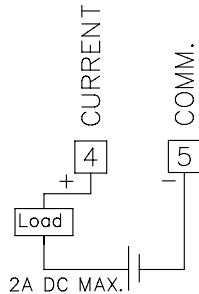

Current Signal (2 wire requiring excitation)

Terminal 4: -ADC
Terminal 6: +ADC
Excitation Jumper: 24 V

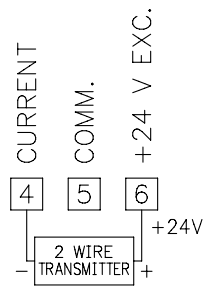

Current Signal (3 wire requiring excitation)

Terminal 4: +ADC (signal)
Terminal 5: -ADC (common)
Terminal 6: +Volt supply
Excitation Jumper: 24 V

Voltage Signal (3 wire requiring excitation)

Terminal 3: +VDC (signal)
Terminal 5: -VDC (common)
Terminal 6: +Volt supply
Excitation Jumper: 24 V

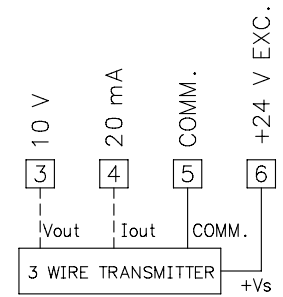

Resistance Signal (3 wire requiring excitation)

Terminal 3: Resistance
Terminal 5: Resistance
Terminal 6: Jumper to terminal 3
Excitation Jumper: 1.75 mA REF.

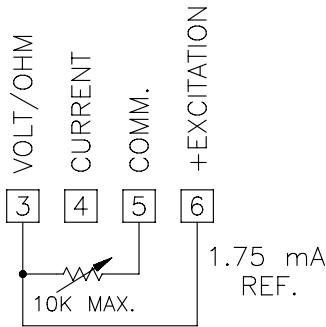

Potentiometer Signal (3 wire requiring excitation)

Terminal 3: Wiper
Terminal 5: Low end of pot.
Terminal 6: High end of pot.
Excitation Jumper: 2 V REF.
Input Range Jumper: 2 Volt
Module 1 Input Range: 2 Volt

Note: The Apply signal scaling style should be used because the signal will be in volts.

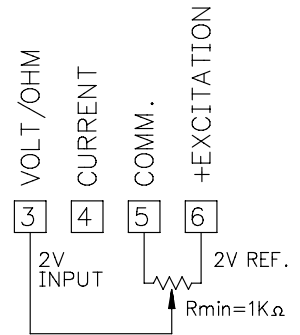

CAUTION: Sensor input common is NOT isolated from user input common. In order to preserve the safety of the meter application, the sensor input common must be suitably isolated from hazardous live earth referenced voltages; or input common must be at protective earth ground potential. If not, hazardous live voltage may be present at the User Inputs and User Input Common terminals. Appropriate considerations must then be given to the potential of the user input common with respect to earth common; and the common of the isolated plug-in cards with respect to input common.

PAXP INPUT SIGNAL WIRING

Voltage Signal (self powered)

Terminal 3: +VDC
Terminal 5: -VDC

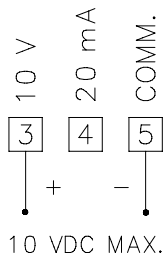

Current Signal (self powered)

Terminal 4: +ADC
Terminal 5: -ADC

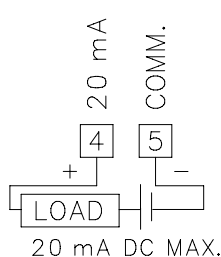

Current Signal (2 wire requiring excitation)

Terminal 4: -ADC
Terminal 6: +ADC

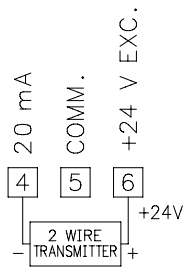

Current Signal (3 wire requiring excitation)

Terminal 4: +ADC (signal)
Terminal 5: -ADC (common)
Terminal 6: +Volt supply

Voltage Signal (3 wire requiring excitation)

Terminal 3: +VDC (signal)
Terminal 5: -VDC (common)
Terminal 6: +Volt supply

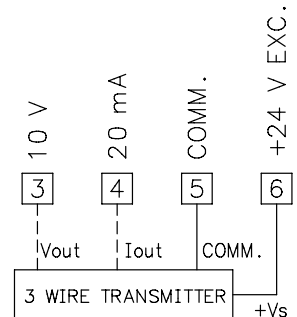

CAUTION: Sensor input common is NOT isolated from user input common. In order to preserve the safety of the meter application, the sensor input common must be suitably isolated from hazardous live earth referenced voltages; or input common must be at protective earth ground potential. If not, hazardous live voltage may be present at the User Inputs and User Input Common terminals. Appropriate considerations must then be given to the potential of the user input common with respect to earth common; and the common of the isolated plug-in cards with respect to input common.

PAXH INPUT SIGNAL WIRING

Before connecting signal wires, the Signal, Input Range and Couple Jumpers should be verified for proper position.

Voltage Signal

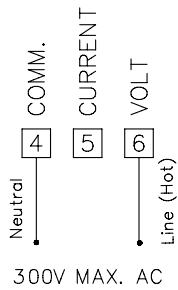

Current Signal (Amps)

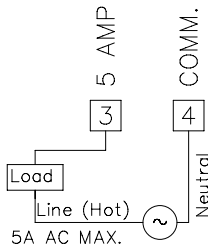

Current Signal (Milliamps)

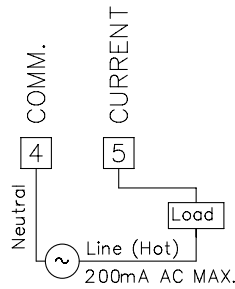

CAUTION: Connect only one input signal range to the meter. Hazardous signal levels may be present on unused inputs.

CAUTION: The isolation rating of the input common of the meter with respect to the option card commons and the user input common Terminal 8 (If used) is 125 Vrms; and 250 Vrms with respect to AC Power (meter Terminals 1 & 2). To be certain that the ratings are not exceeded, these voltages should be verified by a high-voltage meter before wiring the meter.



CAUTION:

1. Where possible, connect the neutral side of the signal (including current shunts) to the input common of the meter. If the input signal is sourced from an active circuit, connect the lower impedance (usually circuit common) to the input signal common of the meter.
2. For phase-to-phase line monitoring where a neutral does not exist, or for any other signal input in which the isolation voltage rating is exceeded, an isolating potential transformer must be used to isolate the input voltage from earth. With the transformer, the input common of the meter can then be earth referenced for safety.
3. When measuring line currents, the use of a current transformer is recommended. If using external current shunts, insert the shunt in the neutral return line. If the isolation voltage rating is exceeded, the use of an isolating current transformer is necessary.

PAXS INPUT SIGNAL WIRING

Before connecting signal wires, the Input Range Jumper should be verified for proper position.

2-Wire Single Ended Input

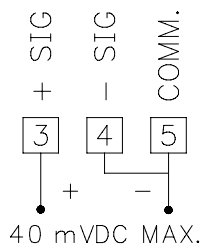

4-Wire Bridge Input

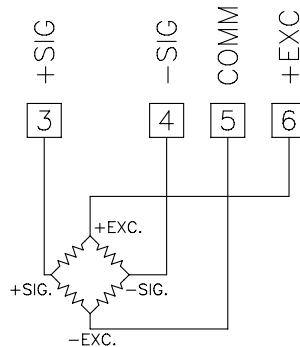

6-Wire Bridge Input

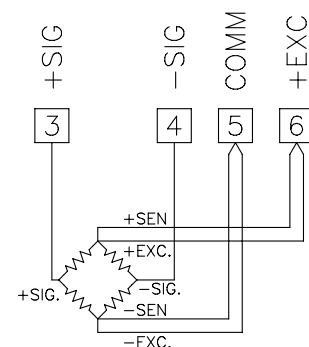

DEADLOAD COMPENSATION

In some cases, the combined deadload and liveload output may exceed the range of the 24 mV input. To use this range, the output of the bridge can be offset a small amount by applying a fixed resistor across one arm of the bridge. This shifts the electrical output of the bridge downward to within the operating range of the meter. A 100 K ohm fixed resistor shifts the bridge output approximately -10 mV (350 ohm bridge, 10 V excitation).

Connect the resistor between +SIG and -SIG. Use a metal film resistor with a low temperature coefficient of resistance.

BRIDGE COMPLETION RESISTORS

For single strain gage applications, bridge completion resistors must be employed externally to the meter. Only use metal film resistors with a low temperature coefficient of resistance.

Load cells and pressure transducers are normally implemented as full resistance bridges and do not require bridge completion resistors.

PAXT INPUT SIGNAL WIRING

Thermocouple

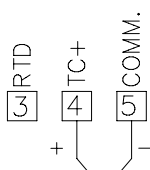

3-Wire RTD

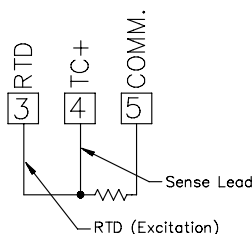

2-Wire RTD

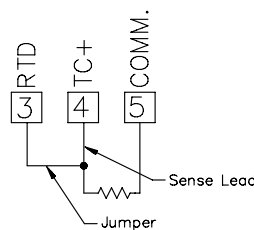

CAUTION: Sensor input common is NOT isolated from user input common. In order to preserve the safety of the meter application, the sensor input common must be suitably isolated from hazardous live earth referenced voltages; or input common must be at protective earth ground potential. If not, hazardous live voltage may be present at the User Inputs and User Input Common terminals. Appropriate considerations must then be given to the potential of the user input common with respect to earth common; and the common of the isolated plug-in cards with respect to input common.

3.3 USER INPUT WIRING

Before connecting the wires, the User Input Logic Jumper should be verified for proper position. If not using User Inputs, then skip this section. Only the appropriate User Input terminal has to be wired.

Sinking Logic

Terminal 8-10: } Connect external switching device between
Terminal 7: } appropriate User Input terminal and User Comm.

In this logic, the user inputs of the meter are internally pulled up to +5 V with 22 K resistance. The input is active when it is pulled low (<0.9 V).

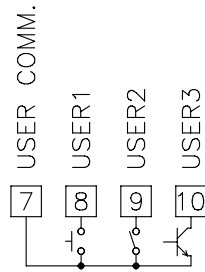

Sourcing Logic

Terminal 8-10: +VDC thru external switching device
Terminal 7: -VDC thru external switching device

In this logic, the user inputs of the meter are internally pulled down to 0 V with 22 K resistance. The input is active when a voltage greater than 3.6 VDC is applied.

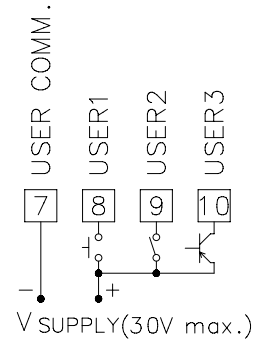

PAXH ONLY

Sinking Logic

Terminals 9-11 } Connect external
Terminal 8 } switching device between
appropriate User Input
terminal and User Comm.

In this logic, the user inputs of the meter are internally pulled up to +5 V with 22 K resistance. The input is active when it is pulled low (<0.9 V).

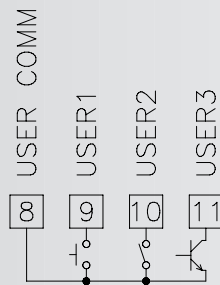

Sourcing Logic

Terminals 9-11: +VDC through external switching device
Terminal 8: -VDC through external switching device

In this logic, the user inputs of the meter are internally pulled down with 22 K resistance. The input is active when a voltage greater than 3.6 VDC is applied.

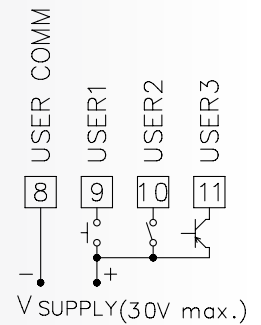

3.4 SETPOINT (ALARMS) WIRING 3.5 SERIAL COMMUNICATION WIRING 3.6 ANALOG OUTPUT WIRING

See appropriate plug-in card bulletin for details.

4.0 REVIEWING THE FRONT BUTTONS AND DISPLAY

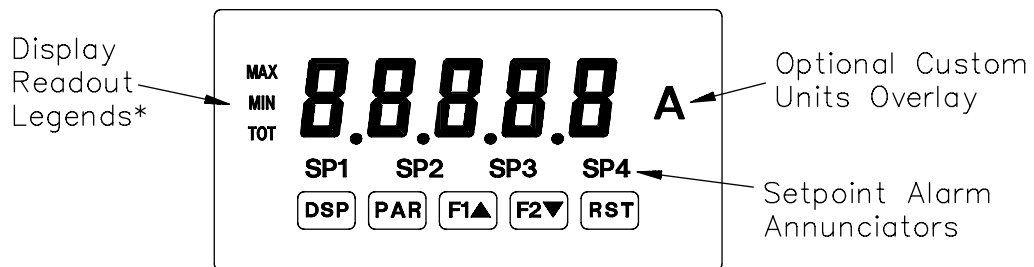

KEY DISPLAY MODE OPERATION

- DSP** Index display through max/min/total/input readouts
- PAR** Access parameter list
- F1▲** Function key 1; hold for 3 seconds for Second Function 1**
- F2▼** Function key 2; hold for 3 seconds for Second Function 2**
- RST** Reset (Function key)**

* Display Readout Legends may be locked out in Factory Settings.

** Factory setting for the F1, F2, and RST keys is NO mode.

PROGRAMMING MODE OPERATION

- Quit programming and return to display mode
- Store selected parameter and index to next parameter
- Increment selected parameter value
- Decrement selected parameter value
- Hold with F1▲, F2▼ to scroll value by x1000

5.0 PROGRAMMING THE METER

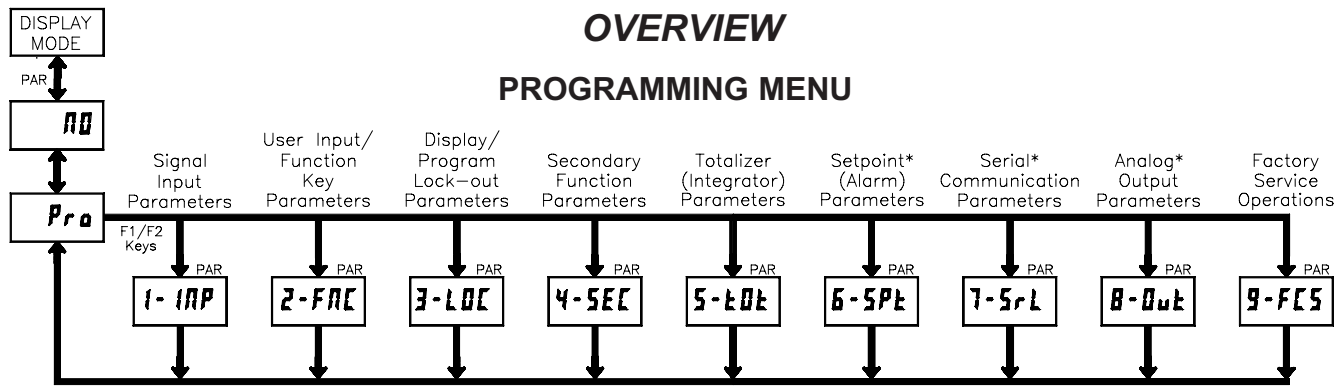

* Only accessible with appropriate plug-in card.

DISPLAY MODE

The meter normally operates in the Display Mode. In this mode, the meter displays can be viewed consecutively by pressing the **DSP** key. The annunciators to the left of the display indicate which display is currently shown; Max Value (MAX), Min Value (MIN), or Totalizer Value (TOT). Each of these displays can be locked from view through programming. (See Module 3) The Input Display Value is shown with no annunciator.

PROGRAMMING MODE

Two programming modes are available.

Full Programming Mode permits all parameters to be viewed and modified. Upon entering this mode, the front panel keys change to Programming Mode operations. This mode should not be entered while a process is running, since the meter functions and User Input response may not operate properly while in Full Programming Mode.

Quick Programming Mode permits only certain parameters to be viewed and/or modified. When entering this mode, the front panel keys change to Programming Mode operations, and all meter functions continue to operate properly. Quick Programming Mode is configured in Module 3. The Display Intensity Level “d-LEu” parameter is available in the Quick Programming Mode only when the security code is non-zero. For a description, see Module 9—Factory Service Operations. Throughout this document, Programming Mode (without Quick in front) always refers to “Full” Programming Mode.

PROGRAMMING TIPS

The Programming Menu is organized into nine modules (See above). These modules group together parameters that are related in function. It is recommended to begin programming with Module 1 and proceed through each module in sequence. Note that Modules 6 through 8 are only accessible when the appropriate plug-in option card is installed. If lost or confused while programming, press the **DSP** key to exit programming mode and start over. When programming is complete, it is recommended to record the meter settings on the Parameter Value Chart and lock-out parameter programming with a User Input or lock-out code. (See Modules 2 and 3 for lock-out details.)

FACTORY SETTINGS

Factory Settings may be completely restored in Module 9. This is a good starting point if encountering programming problems. Throughout the module description sections which follow, the factory setting for each parameter is shown below the parameter display. In addition, all factory settings are listed on the Parameter Value Chart following the programming section.

ALTERNATING SELECTION DISPLAY

In the module description sections which follow, the dual display with arrows appears for each programming parameter. This is used to illustrate the display alternating between the parameter (top display) and the parameter's Factory Setting (bottom display). In most cases, selections or value ranges for the parameter will be listed on the right.

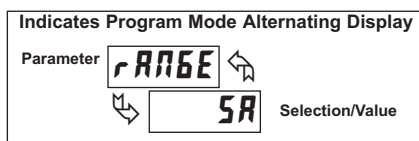

STEP BY STEP PROGRAMMING INSTRUCTIONS:

PROGRAMMING MODE ENTRY (PAR KEY)

The Programming Mode is entered by pressing the **PAR** key. If this mode is not accessible, then meter programming is locked by either a security code or a hardware lock. (See Modules 2 and 3 for programming lock-out details.)

MODULE ENTRY (ARROW & PAR KEYS)

Upon entering the Programming Mode, the display alternates between **Pr0** and the present module (initially **Pr0**). The arrow keys (**F1▲** and **F2▼**) are used to select the desired module, which is then entered by pressing the **PAR** key.

PARAMETER (MODULE) MENU (PAR KEY)

Each module has a separate parameter menu. These menus are shown at the start of each module description section which follows. The **PAR** key is pressed to advance to a particular parameter to be changed, without changing the programming of preceding parameters. After completing a module, the display will return to **Pr0 Pr0**. From this point, programming may continue by selecting and entering additional modules. (See **MODULE ENTRY** above.)

PARAMETER SELECTION ENTRY (ARROW & PAR KEYS)

For each parameter, the display alternates between the parameter and the present selection or value for that parameter. For parameters which have a list of selections, the arrow keys (**F1▲** and **F2▼**) are used to sequence through the list until the desired selection is displayed. Pressing the **PAR** key stores and activates the displayed selection, and also advances the meter to the next parameter.

NUMERICAL VALUE ENTRY (ARROW, RST & PAR KEYS)

For parameters which require a numerical value entry, the arrow keys can be used to increment or decrement the display to the desired value. When an arrow key is pressed and held, the display automatically scrolls up or scrolls down. The longer the key is held, the faster the display scrolls.

The **RST** key can be used in combination with the arrow keys to enter large numerical values. When the **RST** key is pressed along with an arrow key, the display scrolls by 1000's. Pressing the **PAR** key stores and activates the displayed value, and also advances the meter to the next parameter.

PROGRAMMING MODE EXIT (DSP KEY or PAR KEY at Pr0 Pr0)

The Programming Mode is exited by pressing the **DSP** key (from anywhere in the Programming Mode) or the **PAR** key (with **Pr0 Pr0** displayed). This will commit any stored parameter changes to memory and return the meter to the Display Mode. If a parameter was just changed, the **PAR** key should be pressed to store the change before pressing the **DSP** key. (If power loss occurs before returning to the Display Mode, verify recent parameter changes.)

5.1 MODULE 1 - SIGNAL INPUT PARAMETERS (1-11P)

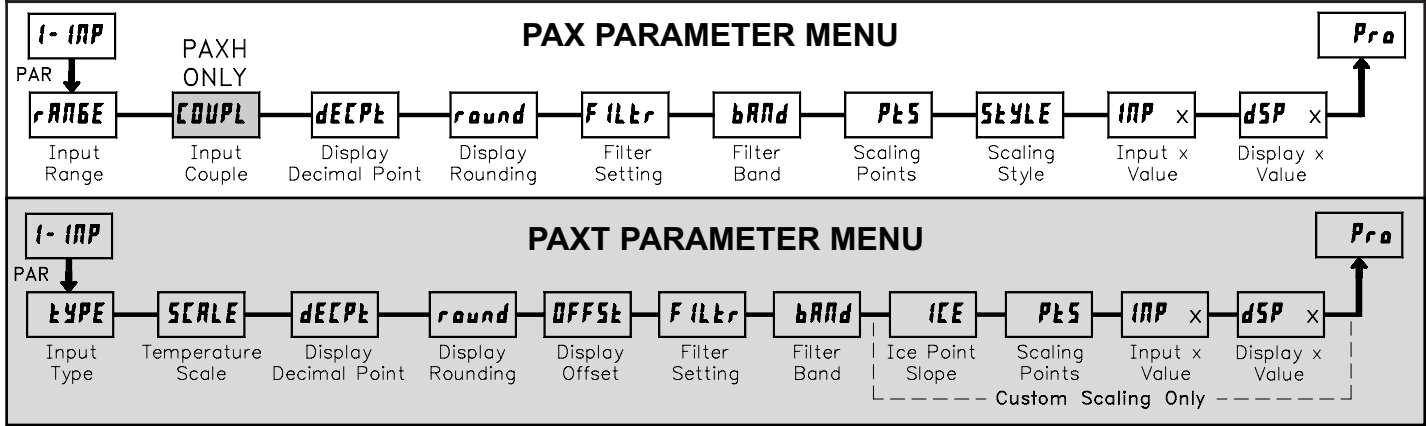

Refer to the appropriate Input Range for the selected meter. Use only one Input Range, then proceed to Display Decimal Point.

PAXD INPUT RANGE

SELECTION	RANGE	RESOLUTION	SELECTION	RANGE	RESOLUTION
300u	200uA	±200.00 µA	2u	±2.0000 V	
	0.002A	±2.0000 mA	20u	±20.000 V	
	0.02A	±20.0000 mA	300u	±300.00 V	
	0.2A	±200.00 mA	100o	100.00 ohm	
	2A	±2.0000 A	1000o	1000.0 ohm	
	0.2u	±200.00 mV	10k	10000 ohm	

Select the input range that corresponds to the external signal. This selection should be high enough to avoid input signal overload but low enough for the desired input resolution. This selection and the position of the Input Range Jumper must match.

PAXP INPUT RANGE

SELECTION	RANGE	RESOLUTION
0.02A	20.000 mA	
10u	10.000 V	

Select the input range that corresponds to the external signal.

PAXH INPUT RANGE

SELECTION	RANGE	RESOLUTION	SELECTION	RANGE	RESOLUTION
5A	0.2u	200.00 mV	0.002A	2.0000 mA	
	2u	2.0000 V	0.02A	20.000 mA	
	20u	20.000 V	0.2A	200.00 mA	
	300u	300.0 V	5A	5.000 A	
	200uA	200.00 µA			

Select the input range that corresponds to the external signal. This selection should be high enough to avoid input signal overload but low enough for the desired input resolution. This selection and the position of the Input Range Jumper must match.

PAXH INPUT COUPLE

SELECTION	AC or DC
AC	AC or DC

The input signal can be either AC coupled (rejecting the DC components of the signal) or DC coupled (measures both the AC and DC components of the signal). The coupling jumper and the setting of this parameter must match.

PAXS INPUT RANGE

SELECTION	RANGE	RESOLUTION
0.02u	±24 mV	
0.2u	±240 mV	

Select the input range that corresponds to the external signal. This selection should be high enough to avoid input signal overload but low enough for the desired input resolution. This selection and the position of the Input Range Jumper must match.

PAXT INPUT TYPE

SELECTION	TYPE	SELECTION	TYPE
tc-c	T TC	tc-c	C TC
tc-E	E TC	Pt385	RTD platinum 385
tc-J	J TC	Pt392	RTD platinum 392
tc-N	K TC	Ni672	RTD nickel 672
tc-r	R TC	Cu427	RTD copper 10 Ω
tc-S	S TC	CS-tc	Custom TC
tc-b	B TC	CS-rH	Custom RTD High
tc-n	N TC	CS-rL	Custom RTD Low

Select the input type that corresponds to the input sensor. For RTD types, check the RTD Input Jumper for matching selection. For custom types, the Temperature Scale parameter is not available, the Display Decimal Point is expanded, and Custom Sensor Scaling must be completed.

PAXT TEMPERATURE SCALE

SELECTION	OF	oC
oF	oF	oC

Select the temperature scale. This selection applies for Input, MAX, MIN, and TOT displays. This does not change the user installed Custom Units Overlay display. If changed, those parameters that relate to the temperature scale should be checked. This selection is not available for custom sensor types.

DISPLAY DECIMAL POINT

SELECTION	0	00	000	0000	00000
0	0	00	000	0000	00000

For the PAXT, these are only available with Custom Scaling.

Select the decimal point location for the Input, MAX and MIN displays. (The TOT display decimal point is a separate parameter.) This selection also affects round, dSP1 and dSP2 parameters and setpoint values.

DISPLAY ROUNDING*



These bottom selections are not available for the PAXT.

Rounding selections other than one, cause the Input Display to 'round' to the nearest rounding increment selected (ie. rounding of '5' causes 122 to round to 120 and 123 to round to 125). Rounding starts at the least significant digit of the Input Display. Remaining parameter entries (scaling point values, setpoint values, etc.) are not automatically adjusted to this display rounding selection.

PAXT: TEMPERATURE DISPLAY OFFSET*



The temperature display can be corrected with an offset value. This can be used to compensate for probe errors, errors due to variances in probe placement or adjusting the readout to a reference thermometer. This value is automatically updated after a Zero Display to show how far the display is offset. A value of zero will remove the affects of offset.

FILTER SETTING*



The input filter setting is a time constant expressed in tenths of a second. The filter settles to 99% of the final display value within approximately 3 time constants. This is an Adaptive Digital Filter which is designed to steady the Input Display reading. A value of '0' disables filtering.

FILTER BAND*



The digital filter will adapt to variations in the input signal. When the variation exceeds the input filter band value, the digital filter disengages. When the variation becomes less than the band value, the filter engages again. This allows for a stable readout, but permits the display to settle rapidly after a large process change. The value of the band is in display units, independent of the Display Decimal Point position. A band setting of '0' keeps the digital filter permanently engaged.

For the PAXT, the following parameters only apply to Custom Sensor Scaling.

PAXT: ICE POINT SLOPE



This parameter sets the slope value for ice point compensation for the Custom TC range (E5-E6) only. The fixed thermocouple ranges are automatically compensated by the meter and do not require this setting. To calculate this slope, use µV data obtained from thermocouple manufacturers' tables for two points between 0°C and 50°C. Place this corresponding µV and °C information into the equation:

$$\text{slope} = (\mu V_2 - \mu V_1) / (C_2 - C_1)$$

Due to the nonlinear output of thermocouples, the compensation may show a small offset error at room temperatures. This can be compensated by the offset parameter. A value of 0 disables internal compensation when the thermocouple is externally compensated.

* Factory Setting can be used without affecting basic start-up.

SCALING POINTS*



Linear - Scaling Points (2)

For linear processes, only 2 scaling points are necessary. It is recommended that the 2 scaling points be at opposite ends of the input signal being applied. The points do not have to be the signal limits. Display scaling will be linear between and continue past the entered points up to the limits of the Input Signal Jumper position. Each scaling point has a coordinate-pair of Input Value (*INP*) and an associated desired Display Value (*dSP*).

Nonlinear - Scaling Points (Greater than 2)

For non-linear processes, up to 16 scaling points may be used to provide a piece-wise linear approximation. (The greater the number of scaling points used, the greater the conformity accuracy.) The Input Display will be linear between scaling points that are sequential in program order. Each scaling point has a coordinate-pair of Input Value (*INP*) and an associated desired Display Value (*dSP*). Data from tables or equations, or empirical data could be used to derive the required number of segments and data values for the coordinate pairs. In the SFPAX software, several linearization equations are available.

SCALING STYLE

This parameter does not apply for the PAXT. Scaling values for the PAXT must be keyed-in.



If Input Values and corresponding Display Values are known, the Key-in (*KEY*) scaling style can be used. This allows scaling without the presence or changing of the input signal. If Input Values have to be derived from the actual input signal source or simulator, the Apply (*APPLY*) scaling style must be used.

INPUT VALUE FOR SCALING POINT 1

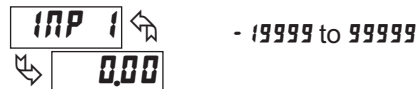

For Key-in (*KEY*), enter the known first Input Value by using the arrow keys. (The Input Range selection sets up the decimal location for the Input Value). For Apply (*APPLY*), apply the input signal to the meter, adjust the signal source externally until the desired Input Value appears. In either method, press the **PAR** key to enter the value being displayed. The **DSP** key can be pressed without changing the previously stored *INP 1* value in the *APPLY* style.

DISPLAY VALUE FOR SCALING POINT 1



Enter the first coordinating Display Value by using the arrow keys. This is the same for *KEY* and *APPLY* scaling styles. The decimal point follows the *DECPt* selection.

INPUT VALUE FOR SCALING POINT 2



For Key-in (*KEY*), enter the known second Input Value by using the arrow keys. For Apply (*APPLY*), adjust the signal source externally until the next desired Input Value appears. (Follow the same procedure if using more than 2 scaling points.)

DISPLAY VALUE FOR SCALING POINT 2



- 9999 to 99999

Enter the second coordinating Display Value by using the arrow keys. This is the same for **KEY** and **RPLY** scaling styles. (Follow the same procedure if using more than 2 scaling points.)

General Notes on Scaling

1. Input Values for scaling points should be confined to the limits of the Input Range Jumper position.
2. The same Input Value should not correspond to more than one Display Value. (Example: 20 mA can not equal 0 and 10.) This is referred to as read out jumps (vertical scaled segments).
3. The same Display Value can correspond to more than one Input Value. (Example: 0 mA and 20 mA can equal 10.) This is referred to as readout dead zones (horizontal scaled segments).

4. The maximum scaled Display Value spread between range maximum and minimum is limited to 65,535. For example using +20 mA range the maximum +20 mA can be scaled to is 32,767 with 0 mA being 0 and Display Rounding of 1. (Decimal points are ignored.) The other half of 65,535 is for the lower half of the range 0 to -20 mA even if it is not used. With Display Rounding of 2, +20 mA can be scaled for 65,535 (32,767 x 2) but with even Input Display values shown.
5. For input levels beyond the first programmed Input Value, the meter extends the Display Value by calculating the slope from the first two coordinate pairs ($INP1 / dSP1$ & $INP2 / dSP2$). If $INP1 = 4$ mA and $dSP1 = 0$, then 0 mA would be some negative Display Value. This could be prevented by making $INP1 = 0$ mA / $dSP1 = 0$, $INP2 = 4$ mA / $dSP2 = 0$, with $INP3 = 20$ mA / $dSP3 =$ the desired high Display Value. The calculations stop at the limits of the Input Range Jumper position.
6. For input levels beyond the last programmed Input Value, the meter extends the Display Value by calculating the slope from the last two sequential coordinate pairs. If three coordinate pair scaling points were entered, then the Display Value calculation would be between $INP2 / dSP2$ & $INP3 / dSP3$. The calculations stop at the limits of the Input Range Jumper position.

5.2 MODULE 2 - USER INPUT AND FRONT PANEL FUNCTION KEY PARAMETERS (2-FNC)

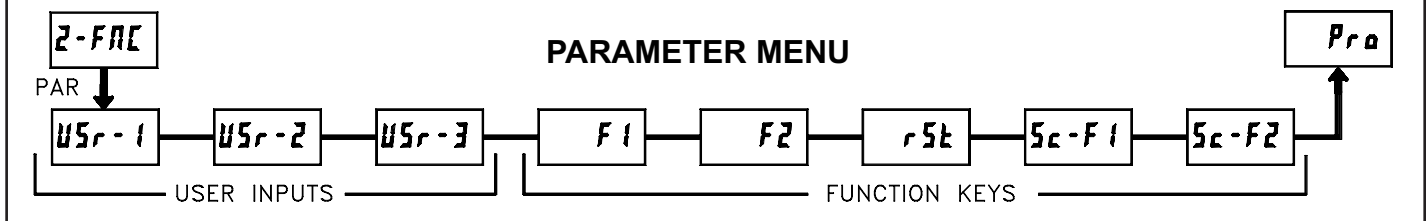

The three user inputs are individually programmable to perform specific meter control functions. While in the Display Mode or Program Mode, the function is executed the instant the user input transitions to the active state.

The front panel function keys are also individually programmable to perform specific meter control functions. While in the Display Mode, the primary function is executed the instant the key is pressed. Holding the function key for three seconds executes a secondary function. It is possible to program a secondary function without a primary function.

In most cases, if more than one user input and/or function key is programmed for the same function, the maintained (level trigger) actions will be performed while at least one of those user inputs or function keys are activated. The momentary (edge trigger) actions will be performed every time any of those user inputs or function keys transition to the active state.

Note: In the following explanations, not all selections are available for both user inputs and front panel function keys. Alternating displays are shown with each selection. Those selections showing both displays are available for both. If a display is not shown, it is not available for that selection. **USr-1** will represent all three user inputs. **F1** will represent all five function keys.

NO FUNCTION



No function is performed if activated. This is the factory setting for all user inputs and function keys. No function can be selected without affecting basic start-up.

PROGRAMMING MODE LOCK-OUT

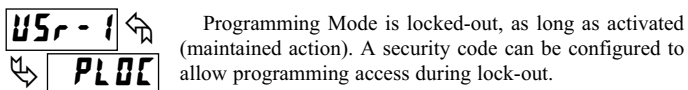

Programming Mode is locked-out, as long as activated (maintained action). A security code can be configured to allow programming access during lock-out.

ZERO (TARE) DISPLAY



The Zero (Tare) Display provides a way to zero the Input Display value at various input levels, causing future Display readings to be offset. This function is useful in weighing applications where the container or material on the scale should not be included in the next measurement value. When activated (momentary action), **rESEt** flashes and the Display is set to zero. At the same time, the Display value (that was on the display before the Zero Display) is subtracted from the Display Offset Value and is automatically stored as the new Display Offset Value (**OFFSt**). If another Zero (tare) Display is performed, the display will again change to zero and the Display reading will shift accordingly.

RELATIVE/ABSOLUTE DISPLAY



This function will switch the Input Display between Relative and Absolute. The Relative is a net value that includes the Display Offset Value. The Input Display will normally show the Relative unless switched by this function. Regardless of the display selected, all meter functions continue to operate based on relative values. The Absolute is a gross value (based on Module 1 **DSP** and **INP** entries) without the Display Offset Value. The Absolute display is selected as long as the user input is activated (maintained action) or at the transition of the function key (momentary action). When the user input is released, or the function key is pressed again, the input display switches back to Relative display. **AbS** (absolute) or **rEL** (relative) is momentarily displayed at transition to indicate which display is active.

HOLD DISPLAY

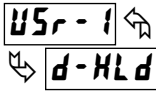

The shown display is held but all other meter functions continue as long as activated (maintained action).

HOLD ALL FUNCTIONS

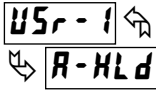

The meter disables processing the input, holds all display contents, and locks the state of all outputs as long as activated (maintained action). The serial port continues data transfer.

SYNCHRONIZE METER READING

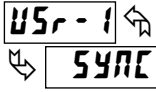

The meter suspends all functions as long as activated (maintained action). When the user input is released, the meter synchronizes the restart of the A/D with other processes or timing events.

STORE BATCH READING IN TOTALIZER



The Input Display value is one time added (batched) to the Totalizer at transition to activate (momentary action). The Totalizer retains a running sum of each batch operation until the Totalizer is reset. When this function is selected, the normal operation of the Totalizer is overridden.

SELECT TOTALIZER DISPLAY

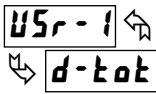

The Totalizer display is selected as long as activated (maintained action). When the user input is released, the Input Display is returned. The **DSP** key overrides the active user input. The Totalizer continues to function including associated outputs independent of being displayed.

RESET TOTALIZER



When activated (momentary action), **rESEt** flashes and the Totalizer resets to zero. The Totalizer then continues to operate as it is configured. This selection functions independent of the selected display.

RESET AND ENABLE TOTALIZER

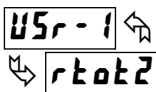

When activated (momentary action), **rESEt** flashes and the Totalizer resets to zero. The Totalizer continues to operate while active (maintained action). When the user input is released, the Totalizer stops and holds its value. This selection functions independent of the selected display.

ENABLE TOTALIZER

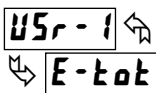

The Totalizer continues to operate as long as activated (maintained action). When the user input is released, the Totalizer stops and holds its value. This selection functions independent of the selected display.

SELECT MAXIMUM DISPLAY

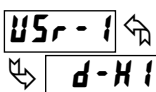

The Maximum display is selected as long as activated (maintained action). When the user input is released, the Input Display returns. The **DSP** key overrides the active user input. The Maximum continues to function independent of being displayed.

RESET MAXIMUM

When activated (momentary action), **rESEt** flashes and the Maximum resets to the present Input Display value. The Maximum function then continues from that value. This selection functions independent of the selected display.

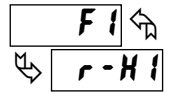

RESET, SELECT, ENABLE MAXIMUM DISPLAY

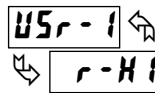

When activated (momentary action), the Maximum value is set to the present Input Display value. Maximum continues from that value while active (maintained action). When the user input is released, Maximum detection stops and holds its value. This selection functions independent of the selected display. The **DSP** key overrides the active user input display but not the Maximum function.

SELECT MINIMUM DISPLAY

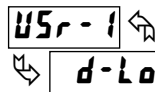

The Minimum display is selected as long as activated (maintained action). When the user input is released, the Input Display is returned. The **DSP** key overrides the active user input. The Minimum continues to function independent of being displayed.

RESET MINIMUM

When activated (momentary action), **rESEt** flashes and the Minimum reading is set to the present Input Display value. The Minimum function then continues from that value. This selection functions independent of the selected display.



RESET, SELECT, ENABLE MINIMUM DISPLAY

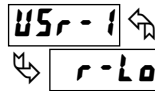

When activated (momentary action), the Minimum value is set to the present Input Display value. Minimum continues from that value while active (maintained action). When the user input is released, Minimum detection stops and holds its value. This selection functions independent of the selected display. The **DSP** key overrides the active user input display but not the Minimum function.

RESET MAXIMUM AND MINIMUM

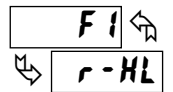
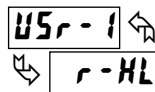

When activated (momentary action), **rESEt** flashes and the Maximum and Minimum readings are set to the present Input Display value. The Maximum and Minimum function then continues from that value. This selection functions independent of the selected display.

CHANGE DISPLAY INTENSITY LEVEL

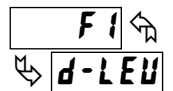
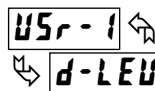

When activated (momentary action), the display intensity changes to the next intensity level (of 4). The four levels correspond to Display Intensity Level (**d-LEU**) settings of 0, 3, 8, and 15. The intensity level, when changed via the User Input/ Function Key, is not retained at power-down, unless Quick Programming or Full Programming mode is entered and exited. The meter will power-up at the last saved intensity level.

SETPOINT SELECTIONS

The following selections are accessible only with the Setpoint plug-in card installed. Refer to the Setpoint Card Bulletin shipped with the Setpoint plug-in card for an explanation of their operation.

Setpoint Card Only

- L15t - Select main or alternate setpoints
- r-1 - Reset Setpoint 1 (Alarm 1)
- r-2 - Reset Setpoint 2 (Alarm 2)
- r-3 - Reset Setpoint 3 (Alarm 3)
- r-4 - Reset Setpoint 4 (Alarm 4)
- r-34 - Reset Setpoint 3 & 4 (Alarm 3 & 4)
- r-234 - Reset Setpoint 2, 3 & 4 (Alarm 2, 3 & 4)
- r-ALL - Reset Setpoint All (Alarm All)

PRINT REQUEST

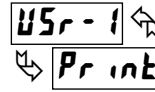

The meter issues a block print through the serial port when activated. The data transmitted during a print request is programmed in Module 7. If the user input is still active after the transmission is complete (about 100 msec), an additional transmission occurs. As long as the user input is held active, continuous transmissions occur.

5.3 MODULE 3 - DISPLAY AND PROGRAM LOCK-OUT PARAMETERS (3-LOC)

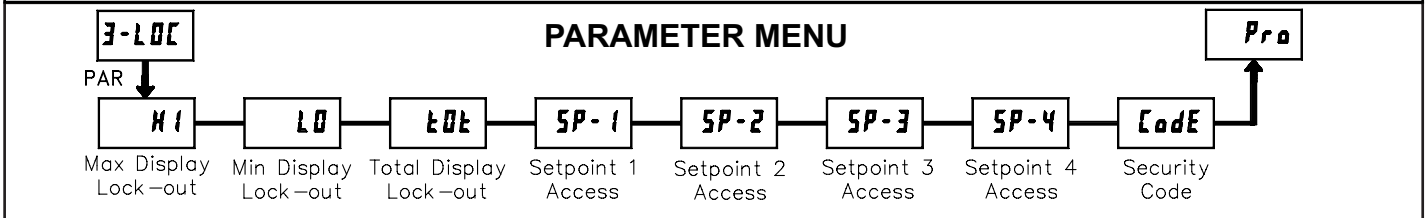

Module 3 is the programming for Display lock-out and “Full” and “Quick” Program lock-out.

When in the Display Mode, the available displays can be read consecutively by repeatedly pressing the **DSP** key. An annunciator indicates the display being shown. These displays can be locked from being visible. It is recommended that the display be set to **LOC** when the corresponding function is not used.

SELECTION	DESCRIPTION
rEd	Visible in Display Mode
LOC	Not visible in Display Mode

“Full” Programming Mode permits all parameters to be viewed and modified. This Programming Mode can be locked with a security code and/or user input. When locked and the **PAR** key is pressed, the meter enters a Quick Programming Mode. In this mode, the setpoint values can still be read and/or changed per the selections below. The Display Intensity Level (*d-LEU*) parameter also appears whenever Quick Programming Mode is enabled and the security code is greater than zero.

SELECTION	DESCRIPTION
rEd	Visible but not changeable in Quick Programming Mode
ENt	Visible and changeable in Quick Programming Mode
LOC	Not visible in Quick Programming Mode

* Factory Setting can be used without affecting basic start-up.

MAXIMUM DISPLAY LOCK-OUT* MINIMUM DISPLAY LOCK-OUT* TOTALIZER DISPLAY LOCK-OUT*

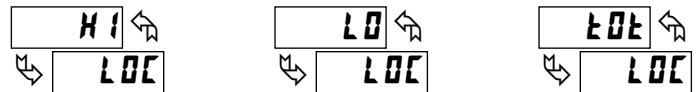

These displays can be programmed for **LOC** or **rEd**. When programmed for **LOC**, the display will not be shown when the **DSP** key is pressed regardless of Program Lock-out status. It is suggested to lock-out the display if it is not needed. The associated function will continue to operate even if its display is locked-out.

SP-1 SP-2 SP-3 SP-4 SETPOINT ACCESS*

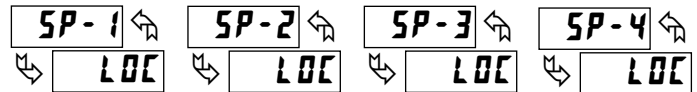

The setpoint displays can be programmed for **LOC**, **rEd** or **ENt** (See the following table). Accessible only with the Setpoint plug-in card installed.

PROGRAM MODE SECURITY CODE*

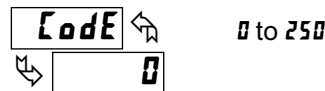

By entering any non-zero value, the prompt **Code 0** will appear when trying to access the Program Mode. Access will only be allowed after entering a matching security code or universal code of **222**. With this lock-out, a user input would not have to be configured for Program Lock-out. However, this lock-out is overridden by an inactive user input configured for Program Lock-out.

PROGRAMMING MODE ACCESS

SECURITY CODE	USER INPUT CONFIGURED	USER INPUT STATE	WHEN PAR KEY IS PRESSED	“FULL” PROGRAMMING MODE ACCESS
0	not PLDC	————	“Full” Programming	Immediate access.
>0	not PLDC	————	Quick Programming w/Display Intensity	After Quick Programming with correct code # at Code prompt.
>0	PLDC	Active	Quick Programming w/Display Intensity	After Quick Programming with correct code # at Code prompt.
>0	PLDC	Not Active	“Full” Programming	Immediate access.
0	PLDC	Active	Quick Programming	No access
0	PLDC	Not Active	“Full” Programming	Immediate access.

Throughout this document, Programming Mode (without Quick in front) always refers to “Full” Programming (all meter parameters are accessible).

5.4 MODULE 4 - SECONDARY FUNCTION PARAMETERS (4-5EE)

PARAMETER MENU

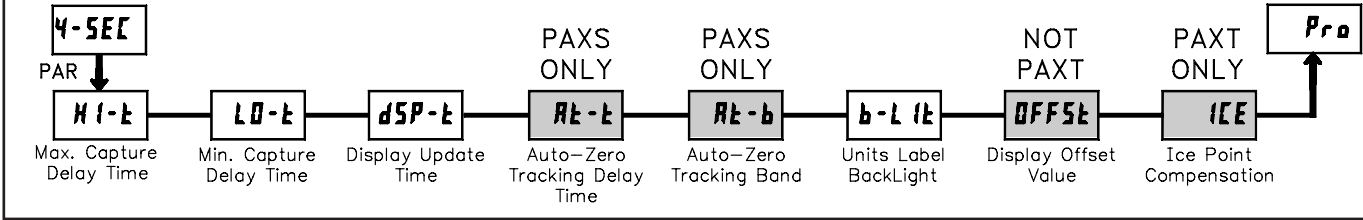

MAX CAPTURE DELAY TIME*

00 to 3275.0 sec.

When the Input Display is above the present MAX value for the entered delay time, the meter will capture that display value as the new MAX reading. A delay time helps to avoid false captures of sudden short spikes.

MIN CAPTURE DELAY TIME*

00 to 3275.0 sec.

When the Input Display is below the present MIN value for the entered delay time, the meter will capture that display value as the new MIN reading. A delay time helps to avoid false captures of sudden short spikes.

DISPLAY UPDATE RATE*

1 2 5 10 20 updates/sec.

This parameter determines the rate of display update. When set to 20 updates/second, the internal re-zero compensation is disabled, allowing for the fastest possible output response.

PAXS: AUTO-ZERO TRACKING

0 to 250 sec.

PAXS: AUTO-ZERO BAND

1 to 4095

The meter can be programmed to automatically compensate for zero drift. Drift may be caused by changes in the transducers or electronics, or accumulation of material on weight systems.

Auto-zero tracking operates when the readout remains within the tracking band for a period of time equal to the tracking delay time. When these conditions are met, the meter re-zeroes the readout. After the re-zero operation, the meter resets and continues to auto-zero track.

The auto-zero tracking band should be set large enough to track normal zero drift, but small enough to not interfere with small process inputs.

For filling operations, the fill rate must exceed the auto-zero tracking rate. This avoids false tracking at the start of the filling operation.

$$\text{Fill Rate} \geq \frac{\text{tracking band}}{\text{tracking time}}$$

Auto-zero tracking is disabled by setting the tracking band parameter = 0.

UNITS LABEL BACKLIGHT*

ON OFF

The Units Label Kit Accessory contains a sheet of custom unit overlays which can be installed in to the meter's bezel display assembly. The backlight for these custom units is activated by this parameter.

DISPLAY OFFSET VALUE*

This parameter does not apply for the PAXT.

- 19999 to 19999

Unless a Zero Display was performed or an offset from Module 1 scaling is desired, this parameter can be skipped. The Display Offset Value is the difference from the Absolute (gross) Display value to the Relative (net) Display value for the same input level. The meter will automatically update this Display Offset Value after each Zero Display. The Display Offset Value can be directly keyed-in to intentionally add or remove display offset. See Relative / Absolute Display and Zero Display explanations in Module 2.

PAXT: ICE POINT COMPENSATION*

ON OFF

This parameter turns the internal ice point compensation on or off. Normally, the ice point compensation is on. If using external compensation, set this parameter to off. In this case, use copper leads from the external compensation point to the meter. If using Custom TC range, the ice point compensation can be adjusted by a value in Module 1 when this is yes.

* Factory Setting can be used without affecting basic start-up.

5.5 MODULE 5 - TOTALIZER (INTEGRATOR) PARAMETERS (5-606)

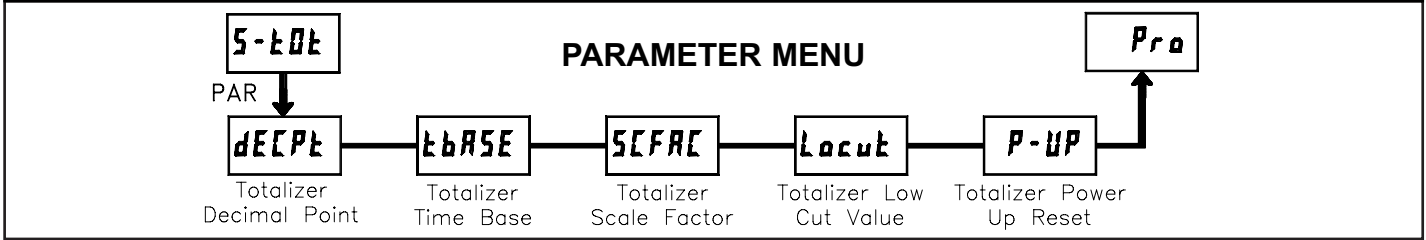

The totalizer accumulates (integrates) the Input Display value using one of two modes. The first is using a time base. This can be used to compute a time-temperature product. The second is through a user input or function key programmed for Batch (one time add on demand). This can be used to provide a readout of temperature integration, useful in curing and sterilization applications. If the Totalizer is not needed, its display can be locked-out and this module can be skipped during programming.

TOTALIZER DECIMAL POINT*



For most applications, this matches the Input Display Decimal Point (dECPt). If a different location is desired, refer to Totalizer Scale Factor.

TOTALIZER TIME BASE

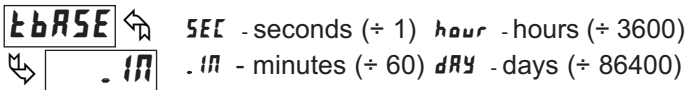

This is the time base used in Totalizer accumulations. If the Totalizer is being accumulated through a user input programmed for Batch, then this parameter does not apply.

TOTALIZER SCALE FACTOR*



For most applications, the Totalizer reflects the same decimal point location and engineering units as the Input Display. In these cases, the Totalizer Scale Factor is 1.000. The Totalizer Scale Factor can be used to scale the Totalizer to a different value than the Input Display. Common possibilities are:

1. Changing decimal point location (example tenths to whole)
2. Average over a controlled time frame.

Details on calculating the scale factor are shown later.

If the Totalizer is being accumulated through a user input programmed for Batch, then this parameter does not apply.

TOTALIZER LOW CUT VALUE*



A low cut value disables Totalizer when the Input Display value falls below the value programmed.

TOTALIZER POWER UP RESET*



The Totalizer can be reset to zero on each meter power-up by setting this parameter to reset.

* Factory Setting can be used without affecting basic start-up.

TOTALIZER HIGH ORDER DISPLAY

When the total exceeds 5 digits, the front panel annunciator TOT flashes. In this case, the meter continues to totalize up to a 9 digit value. The high order 4 digits and the low order 5 digits of the total are displayed alternately. The letter "h" denotes the high order display.

TOTALIZER BATCHING

The Totalizer Time Base and scale factor are overridden when a user input or function key is programmed for store batch (bAt). In this mode, when the user input or function key is activated, the Input Display reading is one time added to the Totalizer (batch). The Totalizer retains a running sum of each batch operation until the Totalizer is reset. This is useful in weighing operations, when the value to be added is not based on time but after a filling event.

TOTALIZER USING TIME BASE

Totalizer accumulates as defined by:

$$\frac{\text{Input Display} \times \text{Totalizer Scale Factor}}{\text{Totalizer Time Base}}$$

Where:

Input Display - the present input reading

Totalizer Scale Factor - 0.001 to 65.000

Totalizer Time Base - (the division factor of tBASE)

Example: The input reading is at a constant rate of 10.0 gallons per minute. The Totalizer is used to determine how many gallons in tenths has flowed. Because the Input Display and Totalizer are both in tenths of gallons, the Totalizer Scale Factor is 1. With gallons per minute, the Totalizer Time Base is minutes (60). By placing these values in the equation, the Totalizer will accumulate every second as follows:

$$\frac{10.0 \times 1.000}{60} = 0.1667 \text{ gallon accumulates each second}$$

This results in:

10.0 gallons accumulates each minute

600.0 gallons accumulates each hour

TOTALIZER SCALE FACTOR CALCULATION EXAMPLES

1. When changing the Totalizer Decimal Point (dECPt) location from the Input Display Decimal Point (dECPt), the required Totalizer Scale Factor is multiplied by a power of ten.

Example: Input (dECPt) = 0.0 Input (dECPt) = 0.00

Totalizer dECPt	Scale Factor
0.00	10
0.0	1
0	.1
x10	.01
x100	.001

Totalizer dECPt	Scale Factor
0.000	10
0.00	1
0.0	.1
0	.01
x10	.001

(x = Totalizer display is round by tens or hundreds)

2. To obtain an average reading within a controlled time frame, the selected Totalizer Time Base is divided by the given time period expressed in the same timing units.

Example: Average temperature per hour in a 4 hour period, the scale factor would be 0.250. To achieve a controlled time frame, connect an external timer to a user input programmed for rAtkZ. The timer will control the start (reset) and the stopping (hold) of the totalizer.

Modules 6, 7, and 8 are accessible only with the appropriate plug-in cards installed. A quick overview of each Module is listed below. Refer to the corresponding plug-in card bulletin for a more detailed explanation of each parameter selection.

5.6 MODULE 6 - SETPOINT (ALARM) PARAMETERS (6-5P6)

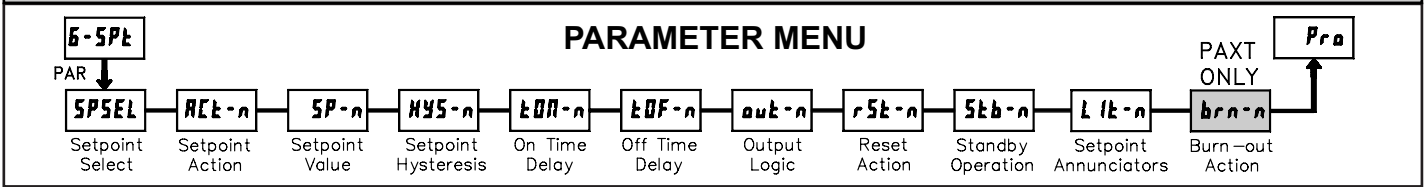

Repeat programming for each setpoint.

SPSEL - SELECT SETPOINT	<i>n0</i> SP-1	SP-3
	SP-2	SP-4
Act-n - SETPOINT ACTION	<i>OFF</i>	<i>dE-HI</i>
	<i>Ab-HI</i>	<i>dE-LO</i>
	<i>Ab-LO</i>	<i>bRNd</i>
	<i>RU-HI</i>	<i>takLo</i>
	<i>RU-LO</i>	<i>takHI</i>
SP-n - SETPOINT VALUE	-19999 to 99999	
HYS-n - SETPOINT HYSTERESIS	1 to 65000	

tOn-n - ON TIME DELAY	00 to 32750 sec	
tOf-n - OFF TIME DELAY	00 to 32750 sec	
out-n - OUTPUT LOGIC	<i>nor</i>	<i>rEu</i>
rSt-n - RESET ACTION	<i>RUt0</i>	<i>LARt2</i>
	<i>LARt1</i>	
Stb-n - STANDBY OPERATION	<i>n0</i>	<i>YES</i>
LIt-n - SETPOINT ANNUNCIATORS	<i>OFF</i>	<i>rEu</i>
	<i>nor</i>	<i>FLASH</i>
brn-n - PROBE BURN-OUT ACTION	<i>0n</i>	<i>OFF</i>
PAXT ONLY		

5.7 MODULE 7 - SERIAL COMMUNICATIONS PARAMETERS (7-5rL)

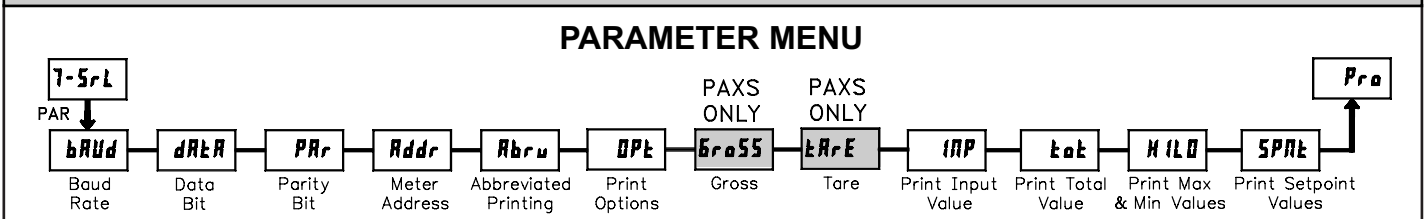

This module is for RS232 and RS485.

bRud - BAUD RATE	300	4800
	600	9600
	1200	19200
	2400	
dARtA - DATA BITS	7	8
PAR - PARITY BIT	<i>Odd</i>	<i>n0</i>
	<i>EVEN</i>	

Addr - METER ADDRESS	0 to 99	
AbRu - ABBREVIATED PRINTING	<i>n0</i>	<i>YES</i>
OPt - PRINT OPTIONS	<i>n0</i>	
	<i>YES</i>	<i>Gross</i>
		<i>tARtE</i>
		<i>INP</i>
		<i>HILO</i>
		<i>tAt</i>
		<i>SPnL</i>

These two options are for the PAXS ONLY.

5.8 MODULE 8 - ANALOG OUTPUT PARAMETERS (8-0ut)

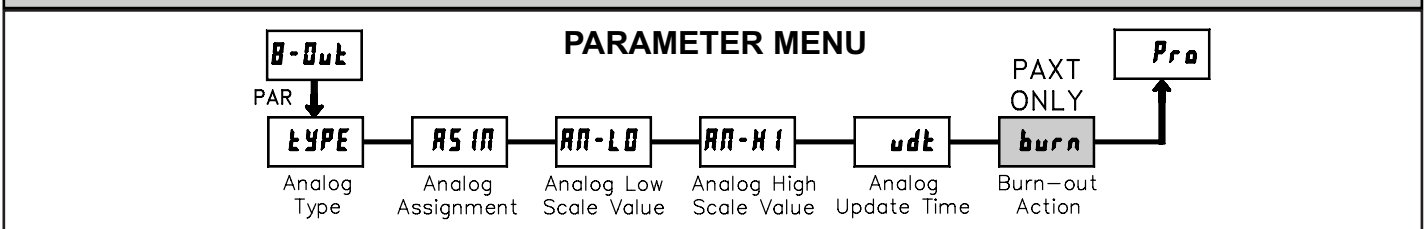

tYPE - ANALOG TYPE	0-20	0-10
	4-20	
AS IN - ANALOG ASSIGNMENT	<i>INP</i>	<i>LO</i>
	<i>HI</i>	<i>tak</i>

AN-LO - ANALOG LOW SCALE VALUE	-19999 to 99999	
AN-HI - ANALOG HIGH SCALE VALUE	-19999 to 99999	
udt - ANALOG UPDATE TIME	00 to 100 sec.	
burn - PROBE BURN-OUT ACTION	<i>HI</i>	<i>LO</i>
PAXT ONLY		

5.9 MODULE 9 - FACTORY SERVICE OPERATIONS (9-F[5])

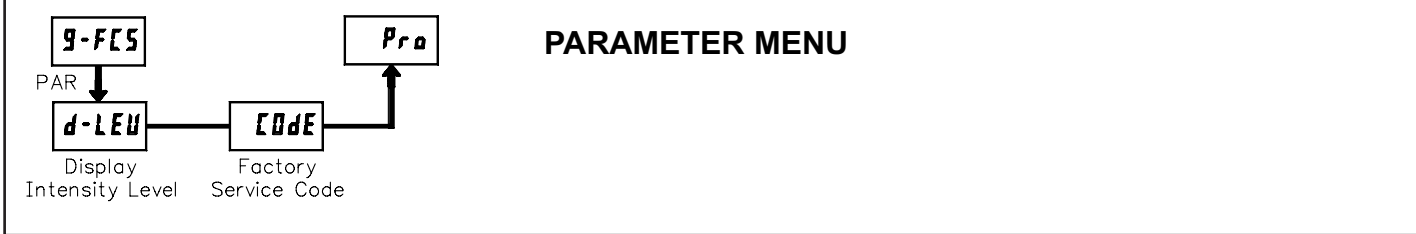

DISPLAY INTENSITY LEVEL

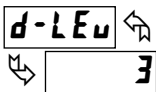

Enter the desired Display Intensity Level (0-15) by using the arrow keys. The display will actively dim or brighten as the levels are changed. This parameter also appears in Quick Programming Mode when enabled.

RESTORE FACTORY DEFAULTS

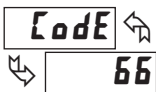

Use the arrow keys to display **CODE 66** and press **PAR**. The meter will display **rESEt** and then return to **CODE 50**. Press **DSP** key to return to Display Mode. This will overwrite all user settings with the factory settings.

CALIBRATION

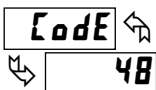

The meter has been fully calibrated at the factory. Scaling to convert the input signal to a desired display value is performed in Module 1. If the meter appears to be indicating incorrectly or inaccurately, refer to Troubleshooting before attempting to calibrate the meter.

When recalibration is required (generally every 2 years), it should only be performed by qualified technicians using appropriate equipment. Calibration does not change any user programmed parameters. However, it may affect the accuracy of the input signal values previously stored using the Apply (**APPLY**) Scaling Style.

Calibration may be aborted by disconnecting power to the meter before exiting Module 9. In this case, the existing calibration settings remain in effect.

PAXP - Input Calibration



WARNING: Calibration of this meter requires a signal source with an accuracy of 0.01% or better and an external meter with an accuracy of 0.005% or better.

Before starting, verify that the precision signal source is connected to the correct terminals and ready. Allow a 30 minute warm-up period before calibrating the meter. **no** and **PAR** can be chosen to exit the calibration mode without any changes taking place.

Then perform the following procedure:

1. Use the arrow keys to display **CODE 48** and press **PAR**.
2. Choose the range to be calibrated by using the arrow keys and press **PAR**. (**no** and **PAR** can be chosen to exit the calibration mode without any changes taking place.)
3. When the zero range limit appears on the display, apply the appropriate:
 - Voltage range: dead short applied
 - Current range: open circuit
4. Press **PAR** and **----** will appear on the display for about 10 seconds.
5. When the top range limit appears on the display, apply the appropriate:
 - Voltage range: 10 VDC
 - Current range: 20 mADC
6. Press **PAR** and **----** will appear on the display for about 10 seconds.
7. When **no** appears, press **PAR** twice.
8. If the meter is not field scaled, then the input display should match the value of the input signal.
9. Repeat the above procedure for each input range to be calibrated.

PAXD - Input Calibration



WARNING: Calibration of this meter requires a signal source with an accuracy of 0.01% or better and an external meter with an accuracy of 0.005% or better. Resistance inputs require a resistance substitution device with an accuracy of 0.01% or better.

Before starting, verify that the Input Ranger Jumper is set for the range to be calibrated. Also verify that the precision signal source is connected and ready. Allow a 30 minute warm-up period before calibrating the meter. **no** and **PAR** can be chosen to exit the calibration mode without any changes taking place.

Then perform the following procedure:

1. Use the arrow keys to display **CODE 48** and press **PAR**.
2. Choose the range to be calibrated by using the arrow keys and press **PAR**.
3. When the zero range limit appears on the display, apply the appropriate:
 - Voltage ranges: dead short applied
 - Current ranges: open circuit
 - Resistance ranges: dead short with current source connected
4. Press **PAR** and **----** will appear on the display for about 10 seconds.
5. When the top range limit appears on the display, apply the appropriate:
 - Voltage ranges: top range value applied (The 300 V range is the exception. It is calibrated with a 100 V signal.)
 - Current ranges: top range value
 - Resistance ranges: top range value (The ohms calibration requires connection of the internal current source through a resistance substitution device and the proper voltage range selection.)
6. Press **PAR** and **----** will appear on the display for about 10 seconds.
7. When **no** appears, press **PAR** twice.
8. If the meter is not field scaled, then the input display should match the value of the input signal.
9. Repeat the above procedure for each input range to be calibrated.

PAXH - Input Calibration



WARNING: In the PAXH, DC signals are used to calibrate the AC ranges. Calibration of the PAXH requires a DC voltmeter with an accuracy of 0.025% and a precision DC signal source capable of:

1. +1% of full scale, DC
2. -1% of full scale, DC
3. +100% of full scale, DC; (300 V range = +100 V calibration)
4. -100% of full scale, DC; (300 V range = -100 V calibration)

Before starting, verify the Input Range and Signal Jumpers are set for the range to be calibrated and the Couple jumper is installed for DC. Also verify the DC signal source is connected and ready. Allow a 30 minute warm-up period before calibrating the meter. **no** and **PAR** can be chosen to exit the calibration mode without any changes taking place.

Then perform the following procedure:

1. Press the arrow keys to display **CODE 48** and press **PAR**.
2. The meter displays **ERR**. Use the arrow keys to select the range that matches the Signal Jumper setting. Press **PAR**.
3. Apply the signal matching the meter prompt.
4. Press **PAR** and **-----** will appear on the display, wait for next prompt.
5. Repeat steps 3 and 4 for the remaining three prompts.
6. When **no** appears, press **PAR** twice.
7. If the meter is scaled to show input signal, the Input Display should match the value of the input signal in the Display Mode.
8. Repeat the above procedure for each range to be calibrated or to recalibrate the same range. It is only necessary to calibrate the input ranges being used.
9. When all desired calibrations are completed, remove the external signal source and restore original configuration and jumper settings. If AC is being measured, continue with AC Couple Offset Calibration.

AC Couple Offset Calibration - PAXH

It is recommended that Input Calibration be performed first.

1. With meter power removed, set the Input Range Jumper for 20 V, the Couple Jumper for DC, and set the Signal Jumper for voltage by removing the jumper.
2. Connect a wire (short) between Volt (terminal 6) and COMM (terminal 4).
3. Apply meter power.
4. In Module 1, program as follows: Range: **20u**; Couple: **dC**; Decimal Point: **0**; Round: **1**; Filter: **0.5**; Band: **20**; Points: **2**; Style: **PEY**; INP1: **0000**; DSP1: **0**; INP2: **20000**; DSP2: **20000**
5. In Module 4, program as follows: Hi-t: **00**; Lo-t: **327.1**
6. Press **PAR** then **DSP** to exit programming and view the Input Display.
7. The readout displays the DC coupled zero input, record the value.
8. Remove the meter power and set the Couple Jumper to AC by removing the jumper.
9. Maintaining the short between terminals 4 and 6, reapply the meter power.
10. Keeping all programming the same, view the Input Display.
11. The readout now displays the AC coupled zero input, record the value.
12. In Module 9, Use the arrow keys to display **Code 4B** and press **PAR**.
13. Press the down arrow key twice to **RL-DF** and press **PAR**.
14. Calculate the offset **OFFSE** using the following formula:
$$\text{OFFSE} = \text{AC coupled reading (step 11)} - \text{DC coupled reading (step 7)}$$
15. Use the arrow keys to enter the calculated **OFFSE**.
16. Press **PAR** three times, to exit programming.
17. Remove the meter power and remove the short from terminals 4 and 6.
18. Restore the original jumper and configuration settings.

PAXS - Input Calibration



WARNING: Calibration of this meter requires a signal source with an accuracy of 0.01% or better and an external meter with an accuracy of 0.005% or better.

Before starting, connect -SIG (terminal 4) to COMM (terminal 5). This allows a single ended signal to be used for calibration. Connect the calibration signal to +SIG (terminal 3) and -SIG (terminal 4). Verify the Input Range jumper is in the desired position. Allow a 30 minute warm-up period before calibrating the meter. **na** and **PAR** can be chosen to exit the calibration mode without any changes taking place. Perform the following procedure:

1. Press the arrow keys to display **Code 4B** and press **PAR**.
2. Choose the range to be calibrated by using the arrow keys and press **PAR**.
3. When the zero range limit appears on the display, apply 0 mV between +SIG and -SIG.
4. Press **PAR** and ---- will appear, wait for next prompt.
5. When the top range limit appears on the display, apply the corresponding +SIG and -SIG voltage (20 mV or 200 mV).
6. Press **PAR** and ---- will appear, on the display for about 10 seconds.
7. When **na** appears, press **PAR** twice to exit programming.
8. Repeat the above procedure for each range to be calibrated or to recalibrate the same range. It is only necessary to calibrate the input ranges being used.
9. When all desired calibrations are completed, remove -SIG to COMM connection and external signal source.
10. Restore original configuration and jumper settings.

PAXT - Input Calibration



Warning: Calibration of this meter requires precision instrumentation operated by qualified technicians. It is recommended that a calibration service calibrates the meter.

Before selecting any of the calibration procedures, the input to the meter must be at 0 mV or 0 ohms. Set the digital filter in Module 1 to 1 second. Allow a 30 minute warm-up period before calibrating the meter. The **na** and **PAR** can be chosen to exit calibration mode without any changes taking place.

10 OHM RTD Range Calibration

1. Set the Input Range Jumper to 10 ohm.
2. Use the arrow keys to display **Code 4B** and press **PAR**. Then choose **r-10** and press **PAR**.
3. At **0 r**, apply a direct short to input terminals 3, 4 and 5 using a three wire link. Wait 10 seconds, then press **PAR**.
4. At **15 r**, apply a precision resistance of 15 ohms (with an accuracy of 0.01% or better) using a three wire link, to input terminals 3, 4 and 5. Wait 10 seconds, then press **PAR**.
5. Connect the RTD, return to the Display Mode and verify the input reading (with 0 Display Offset) is correct. If not correct repeat calibration.

100 OHM RTD Range Calibration

1. Set the Input Range Jumper to 100 ohm.
2. Use the arrow keys to display **Code 4B** and press **PAR**. Then choose **r-100** and press **PAR**.
3. At **0 r**, apply a direct short to input terminals 3, 4 and 5 using a three wire link. Wait 10 seconds, then press **PAR**.
4. At **300 r**, apply a precision resistance of 300 ohms (with an accuracy of 0.01% or better) using a three wire link, to terminals 3, 4 and 5. Wait 10 seconds, press **PAR**.
5. Connect the RTD, return to the Display Mode and verify the input reading (with 0 Display Offset) is correct. If not correct repeat calibration.

THERMOCOUPLE Range Calibration

1. Use the arrow keys to display **Code 4B** and press **PAR**. Then choose **tC** and press **PAR**.
2. At **00 u**, apply a dead short or set calibrator to zero to input terminals 4 and 5. Wait 10 seconds, then press **PAR**.
3. At **500 u**, apply 50.000 mV input signal (with an accuracy of 0.01% or better) to input terminals 4 and 5. Wait 10 seconds, then press **PAR**.
4. Return to the Display Mode.
5. Continue with Ice Point Calibration.

ICE POINT Calibration

1. **Remove all option cards or invalid results will occur.**
2. The ambient temperature must be within 20°C to 30°C.
3. Connect a thermocouple (types T, E, J, K, or N only) with an accuracy of 1°C or better to the meter.
4. Verify the readout Display Offset is 0, Temperature Scale is °C, Display Resolution is 0.0, and the Input Range is set for the connected thermocouple.
5. Place the thermocouple in close thermal contact to a reference thermometer probe. (Use a reference thermometer with an accuracy of 0.25°C or better.) The two probes should be shielded from air movement and allowed sufficient time to equalize in temperature. (A calibration bath could be used in place of the thermometer.)
6. In the Normal Display mode, compare the readouts.
7. If a difference exists then continue with the calibration.
8. Enter Module 9, use the arrow keys to display **Code 4B** and press **PAR**. Then choose **tCE** and press **PAR**.
9. Calculate a new Ice Point value using: existing Ice Point value + (reference temperature - Display Mode reading). All values are based on °C.
10. Enter the new Ice Point value.
11. Return to the Display Mode and verify the input reading (with 0 Display Offset) is correct. If not correct repeat steps 8 through 10.

ANALOG OUTPUT CARD CALIBRATION

Before starting, verify that the precision voltmeter (voltage output) or current meter (current output) is connected and ready. Perform the following procedure:

1. Use the arrow keys to display **Code 4B** and press **PAR**.
2. Use the arrow keys to choose **OUT** and press **PAR**.
3. Using the chart below, step through the five selections to be calibrated. At each prompt, use the PAX arrow keys to adjust the external meter display to match the selection being calibrated. When the external reading matches, or if this range is not being calibrated, press **PAR**.

SELECTION	EXTERNAL METER	ACTION
00 .R	0.00	Adjust if necessary, press PAR
40 .R	4.00	Adjust if necessary, press PAR
200 .R	20.00	Adjust if necessary, press PAR
00 u	0.00	Adjust if necessary, press PAR
100 u	10.00	Adjust if necessary, press PAR

4. When **na** appears remove the external meters and press **PAR** twice.

TROUBLESHOOTING

PROBLEM	REMEDIES
NO DISPLAY	CHECK: Power level, power connections
PROGRAM LOCKED-OUT	CHECK: Active (lock-out) user input ENTER: Security code requested
MAX, MIN, TOT LOCKED-OUT	CHECK: Module 3 programming
INCORRECT INPUT DISPLAY VALUE	CHECK: Module 1 programming, Input Range Jumper position, input connections, input signal level, Module 4 Display Offset is zero, press DSP for Input Display PERFORM: Module 9 Calibration (If the above does not correct the problem.)
"OLOL" in DISPLAY (SIGNAL HIGH)	CHECK: Module 1 programming, Input Range Jumper position, input connections, input signal level
"ULUL" in DISPLAY (SIGNAL LOW)	CHECK: Module 1 programming, Input Range Jumper position, input connections, input signal level
JITTERY DISPLAY	INCREASE: Module 1 filtering, rounding, input range CHECK: Wiring is per EMC installation guidelines
MODULES or PARAMETERS NOT ACCESSIBLE	CHECK: Corresponding plug-in card installation
ERROR CODE (Err 1-4)	PRESS: Reset KEY (If cannot clear contact factory.)
DISPLAY ZERO'S AT LEVELS BELOW 1% OF RANGE	PROGRAM: Module 4 as Hi-t: 0.0 LO-t: 3271.1 (to disable zero chop feature)

For further assistance, contact technical support at the appropriate company numbers listed.

PARAMETER VALUE CHART PAX MODEL NUMBER _____

Programmer _____ Date _____
Meter# _____ Security Code _____

1- INP Signal Input Parameters

DISPLAY	PARAMETER	FACTORY SETTING	USER SETTING	DISPLAY	PARAMETER	FACTORY SETTING	USER SETTING
RANGE	MODEL DEPENDENT			INP 6	* INPUT VALUE 6	0.000	
TYPE	PAXT: INPUT TYPE	tc-J		dSP 6	* DISPLAY VALUE 6	0	
SCALE	PAXT: TEMPERATURE SCALE	OF		INP 7	* INPUT VALUE 7	0.000	
COUPL	PAXH: INPUT COUPLE	AC		dSP 7	* DISPLAY VALUE 7	0	
DECPt	* DISPLAY RESOLUTION	0		INP 8	* INPUT VALUE 8	0.000	
round	DISPLAY ROUNDING INCREMENT	1		dSP 8	* DISPLAY VALUE 8	0	
OFFSEt	PAXT: DISPLAY OFFSET	0		INP 9	* INPUT VALUE 9	0.000	
F ILtR	FILTER SETTING - PAXH 0.5	1.0		dSP 9	* DISPLAY VALUE 9	0	
bAND	FILTER ENABLE BAND - PAXH 0.020	1.0		INP 10	* INPUT VALUE 10	0.000	
ICE	PAXT: ICE POINT SLOPE	0.00		dSP 10	* DISPLAY VALUE 10	0	
PtS	SCALING POINTS	2		INP 11	* INPUT VALUE 11	0.000	
StYLE	SCALING STYLE - NOT PAXT	KEY		dSP 11	* DISPLAY VALUE 11	0	
INP 1	* INPUT VALUE 1	0.000		INP 12	* INPUT VALUE 12	0.000	
dSP 1	* DISPLAY VALUE 1	0		dSP 12	* DISPLAY VALUE 12	0	
INP 2	* INPUT VALUE 2	1.000		INP 13	* INPUT VALUE 13	0.000	
dSP 2	* DISPLAY VALUE 2	1.000		dSP 13	* DISPLAY VALUE 13	0	
INP 3	* INPUT VALUE 3	0.000		INP 14	* INPUT VALUE 14	0.000	
dSP 3	* DISPLAY VALUE 3	0		dSP 14	* DISPLAY VALUE 14	0	
INP 4	* INPUT VALUE 4	0.000		INP 15	* INPUT VALUE 15	0.000	
dSP 4	* DISPLAY VALUE 4	0		dSP 15	* DISPLAY VALUE 15	0	
INP 5	* INPUT VALUE 5	0.000		INP 16	* INPUT VALUE 16	0.000	
dSP 5	* DISPLAY VALUE 5	0		dSP 16	* DISPLAY VALUE 16	0	

* Decimal point location is model and programming dependent.

2-FNC User Input and Function Key Parameters

DISPLAY	PARAMETER	FACTORY SETTING	USER SETTING
USr-1	USER INPUT 1	NO	_____
USr-2	USER INPUT 2	NO	_____
USr-3	USER INPUT 3	NO	_____
F1	FUNCTION KEY 1	NO	_____
F2	FUNCTION KEY 2	NO	_____
rSt	RESET KEY	NO	_____
Sc-F1	2nd FUNCTION KEY 1	NO	_____
Sc-F2	2nd FUNCTION KEY 2	NO	_____

3-LOC Display and Program Lockout Parameters

DISPLAY	PARAMETER	FACTORY SETTING	USER SETTING
H1	MAX DISPLAY LOCKOUT	LOC	_____
L0	MIN DISPLAY LOCKOUT	LOC	_____
t0t	TOTAL DISPLAY LOCKOUT	LOC	_____
SP-1	SETPOINT 1 ACCESS	LOC	_____
SP-2	SETPOINT 2 ACCESS	LOC	_____
SP-3	SETPOINT 3 ACCESS	LOC	_____
SP-4	SETPOINT 4 ACCESS	LOC	_____
Code	SECURITY CODE	0	_____

4-SEC Secondary Function Parameters

DISPLAY	PARAMETER	FACTORY SETTING	USER SETTING
H1-t	MAX CAPTURE DELAY TIME	00	_____
L0-t	MIN CAPTURE DELAY TIME	00	_____
dSP-t	DISPLAY UPDATE TIME	2	_____
Rt-t	PAXS: AUTO-ZERO DELAY	0	_____
Rt-b	PAXS: AUTO-ZERO BAND	002	_____
b-L It	UNITS LABEL BACKLIGHT - PAXT ON	OFF	_____
OFFSt	DISPLAY OFFSET - NOT PAXT	000	_____
ICE	PAXT: ICE POINT COMPENSATION	ON	_____

5-Int Totalizer (Integrator) Parameters

DISPLAY	PARAMETER	FACTORY SETTING	USER SETTING
dECPt	* TOTALIZER DECIMAL POINT	0	_____
tBASE	TOTALIZER TIME BASE	.1n	_____
SCFAC	TOTALIZER SCALE FACTOR	1000	_____
Locut	* TOTALIZER LOW CUT VALUE	-19999	_____
P-UP	TOTALIZER POWER-UP RESET	NO	_____

7-5rL Serial Communication Parameters

DISPLAY	PARAMETER	FACTORY SETTING	USER SETTING
bAUD	BAUD RATE	9600	_____
dARt	DATA BIT	7	_____
PAR	PARITY BIT	Odd	_____
Raddr	METER ADDRESS	0	_____
Rbrv	ABBREVIATED PRINTING	YES	_____
OPT	ENTER PRINT OPTIONS	NO	_____
GrOSS	PAXS: PRINT GROSS OFFSET	NO	_____
tARtE	PAXS: PRINT TARE OFFSET	NO	_____
INP	PRINT INPUT VALUE	YES	_____
t0t	PRINT TOTAL VALUE	YES	_____
H1L0	PRINT MAX & MIN VALUES	YES	_____
SPnt	PRINT SETPOINT VALUES	NO	_____

8-Out Analog Output Parameters

DISPLAY	PARAMETER	FACTORY SETTING	USER SETTING
tYPE	ANALOG TYPE	4-20	_____
AS In	ANALOG ASSIGNMENT	INP	_____
AN-L0	* ANALOG LOW SCALE VALUE	0	_____
AN-H1	* ANALOG HIGH SCALE VALUE	1000	_____
udt	ANALOG UPDATE TIME	00	_____
burn	PAXT: PROBE BURN-OUT ACTION	L0	_____

9-FCS Factory Setting Parameters

DISPLAY	PARAMETER	FACTORY SETTING	USER SETTING
d-LEu	DISPLAY INTENSITY LEVEL	3	_____

6-SPt Setpoint (Alarm) Parameters

DISPLAY	PARAMETER	SP-1		SP-2		SP-3		SP-4	
		FACTORY SETTING	USER SETTING	FACTORY SETTING	USER SETTING	FACTORY SETTING	USER SETTING	FACTORY SETTING	USER SETTING
Rt-n	SETPOINT ACTION	OFF	_____	OFF	_____	OFF	_____	OFF	_____
SP-n	* SETPOINT VALUE (main)	100	_____	200	_____	300	_____	400	_____
	* SETPOINT VALUE (alternate) †	100	_____	200	_____	300	_____	400	_____
HYS-n	* SETPOINT HYSTERESIS	2	_____	2	_____	2	_____	2	_____
tON-n	ON TIME DELAY	00	_____	00	_____	00	_____	00	_____
tOF-n	OFF TIME DELAY	00	_____	00	_____	00	_____	00	_____
out-n	OUTPUT LOGIC	nor	_____	nor	_____	nor	_____	nor	_____
rSt-n	RESET ACTION	RUt0	_____	RUt0	_____	RUt0	_____	RUt0	_____
Stb-n	STANDBY OPERATION	NO	_____	NO	_____	NO	_____	NO	_____
LIt-n	SETPOINT ANNUNCIATORS	nor	_____	nor	_____	nor	_____	nor	_____
burn-n	PAXT: PROBE BURN-OUT ACTION	OFF	_____	OFF	_____	OFF	_____	OFF	_____

† Select alternate list to program these values.

* Decimal point location is model and programming dependent.

LIMITED WARRANTY

The Company warrants the products it manufactures against defects in materials and workmanship for a period limited to one year from the date of shipment, provided the products have been stored, handled, installed, and used under proper conditions. The Company's liability under this limited warranty shall extend only to the repair or replacement of a defective product, at The Company's option. The Company disclaims all liability for any affirmation, promise or representation with respect to the products.

The customer agrees to hold Red Lion Controls harmless from, defend, and indemnify RLC against damages, claims, and expenses arising out of subsequent sales of RLC products or products containing components manufactured by RLC and based upon personal injuries, deaths, property damage, lost profits, and other matters which Buyer, its employees, or sub-contractors are or may be to any extent liable, including without limitation penalties imposed by the Consumer Product Safety Act (P.L. 92-573) and liability imposed upon any person pursuant to the Magnuson-Moss Warranty Act (P.L. 93-637), as now in effect or as amended hereafter.

No warranties expressed or implied are created with respect to The Company's products except those expressly contained herein. The Customer acknowledges the disclaimers and limitations contained herein and relies on no other warranties or affirmations.

Red Lion Controls
20 Willow Springs Circle
York PA 17402
Tel +1 (717) 767-6511
Fax +1 (717) 764-0839

Red Lion Controls BV
Basicweg 11b
NL - 3821 BR Amersfoort
Tel +31 (0) 334 723 225
Fax +31 (0) 334 893 793

Red Lion Controls AP
31, Kaki Bukit Road 3,
#06-04/05 TechLink
Singapore 417818
Tel +65 6744-6613
Fax +65 6743-3360