

Inlet filter, front side mounting, circuit breaker TA45 2-pole

Standard- or Medical-Filter

**Description**

- Panel Mount:  
Screw-on from front side
- 3 Functions:  
Inlet Protection class I, circuit breaker type TA45 2-pole, Line filter in standard and medical version
- Quick connect terminals 6,3 x 0,8 mm
- Alternative: version without line filter [6145](#)
- We recommend for new applications the new type [DF12](#)

**Approvals**

- VDE License Number: 117118
- UL License Number: E72928

**Characteristics**

- All single elements are already wired  
Unwired versions available on request
- Line switch non-illuminated or illuminated  
Thermal overload protection  
Optional with undervoltage release or remote trip release
- Qualified for use in equipment according IEC/EN 60950

**References**[General Product Information](#)**Weblinks**[Approvals](#), [RoHS](#), [CHINA-RoHS](#), [e-Store](#), [SCHURTER-Stock-Check](#), [Distributor-Stock-Check](#)**Technical Data**

Ratings IEC	1 - 10A @ Ta 40 °C / 250VAC; Hz 50
Ratings UL/CSA	1 - 15A @ Ta 40 °C / 125VAC; 60Hz
Leakage Current	standard < 0.5mA (250V / 60Hz) medical < 5 µA (250 V / 60 Hz)
Dielectric Strength	> 1.7kVDC between L-N > 2.7kVDC between L/N-PE Test voltage (2sec)
Allowable Operation Temp.	-10°C to 55°C
Climatic Category	10/055/21 acc. to IEC 60068-1
Degree of Protection	from front side IP 40 acc. to IEC 60529
Protection Class	Suitable for appliances with protection class I acc. to IEC 61140
Terminal	Quick connect terminals 6.3 x 0.8 mm
Panel Thickness s	Screw-on: max 8 mm Mounting screw torque max 0.5Nm
Material: Housing	Thermoplastic, black, UL 94V-0

Appliance-Inlet /-Outlet	C14 acc. to IEC/EN 60320-1, UL 498, CSA C22.2 no. 42 (for cold condition) pin-temperature 70 °C, 10A, Protection class I
Circuit breaker	Acc. IEC/EN 60934, UL 1077, CSA 22.2 no. 235 2-pole rocker switch, illuminated or non-illuminated. Optional with undervoltage- or remote trip release Short circuit capacity Icn: at In < 3A/240VAC : 10 x In at In ≥ 3A/240VAC : 300A
Line Switch	Rocker switch 2-pole non-illuminated or illuminated acc. to IEC 61058-1 <a href="#">Technical details</a>
Line Filter	Standard and Medical Version, IEC 60939, IEC 60601-1, UL 1283, UL 544, EN 133 200, CSA C22.2 no. 8 <a href="#">Technical details</a>
MTBF	> 100'000h acc. to MIL-HB-217 F

## Dimensions

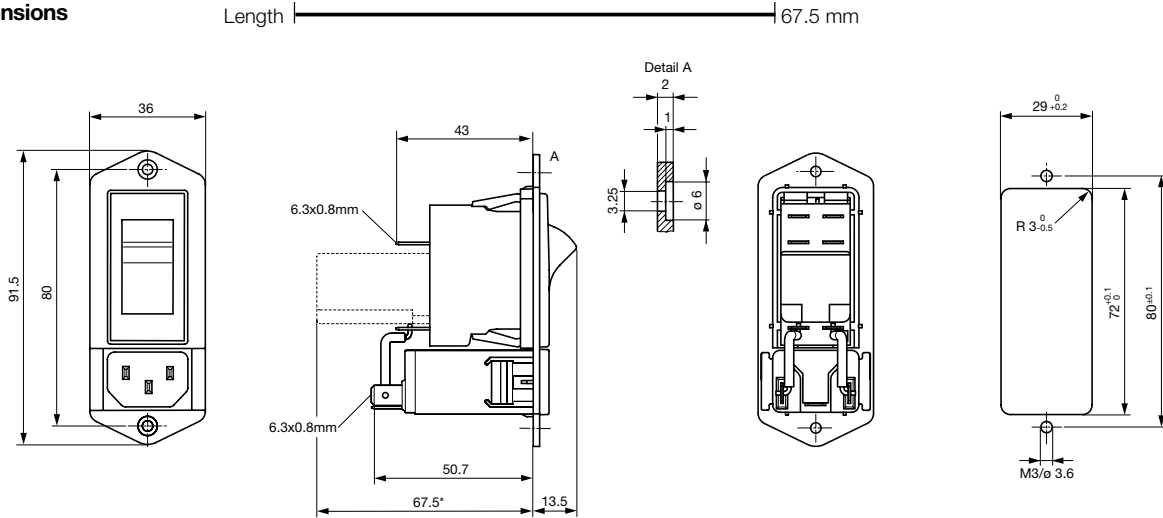

\* --- Version TA45 with undervoltage release

## Technical Data of Filter-Components

Rated Current [A]	Filter-Type	Inductances L [mH]	Capacitance CX [nF]	Capacitance CY [nF]	R [MΩ]
1	Standard Version	2 x 11	47	2.2	-
2	Standard Version	2 x 4	47	2.2	-
3	Standard Version	2 x 2.5	47	2.2	-
4	Standard Version	2 x 1.6	47	2.2	-
6	Standard Version	2 x 0.7	47	2.2	-
8	Standard Version	2 x 0.6	47	2.2	-
10	Standard Version	2 x 0.4	47	2.2	-
15	Standard Version	2 x 0.1	47	2.2	-
1	Medical Version (M5)	2 x 11	47	-	1
2	Medical Version (M5)	2 x 4	47	-	1
6	Medical Version (M5)	2 x 0.7	47	-	1
8	Medical Version (M5)	2 x 0.6	47	-	1
10	Medical Version (M5)	2 x 0.4	47	-	1
15	Medical Version (M5)	2 x 0.1	47	-	1

## Diagrams

Standard version

Medical version

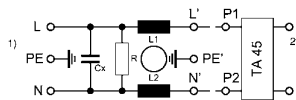
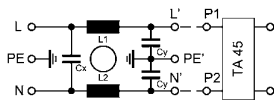

1) Line  
2) Load

1) Line  
2) Load

**Attenuation Loss**

--- differential mode \_\_\_\_ common mode

Standard version

1 A

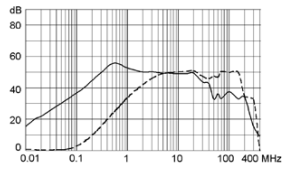

2 A

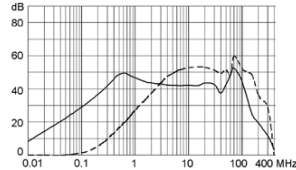

3 A

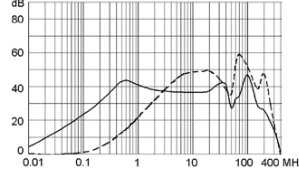

4 A

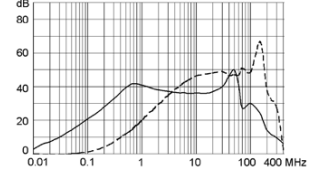

6 A

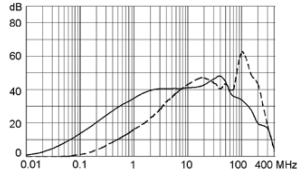

8 A

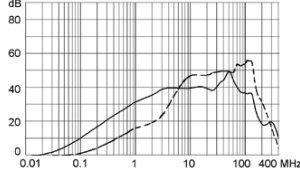

10 A

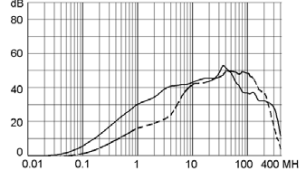

15 A

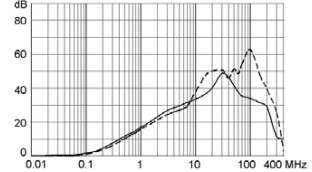

Medical version (M5)

1 A

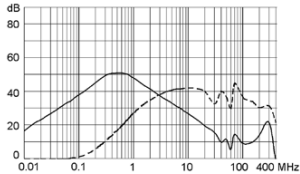

2 A

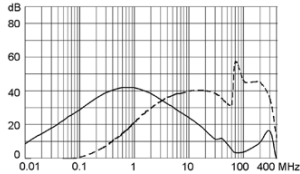

3 A

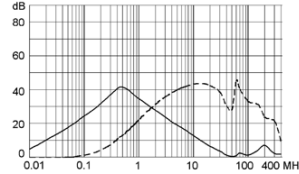

4 A

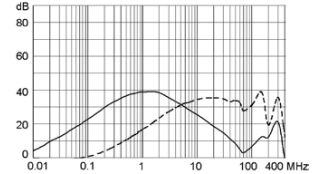

6 A

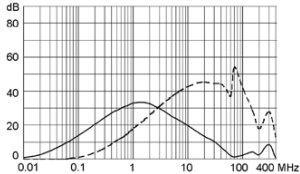

8 A

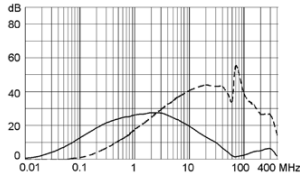

10 A

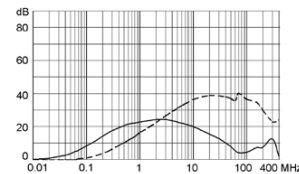

15 A

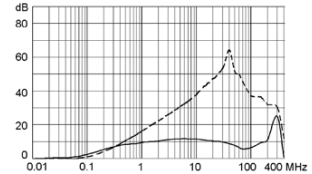

**Packaging unit** 20 Pcs

**Accessory**

Description

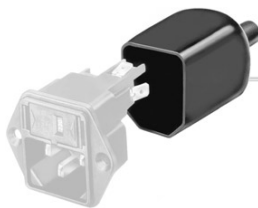

Assorted Covers  
Rear Cover

**Table 1 Selection for type TA45**

Order example



- Line switch
- 2-pole, rocker actuated
- Quick connect terminal
- Other types on request

**ABT** **W** **F** **150** **C0**

**Diagram**

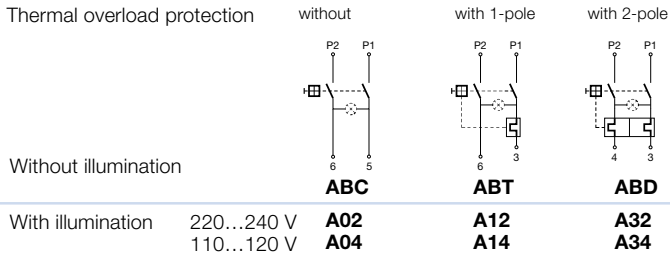

**Colours**

Switch front	Rocker	
<b>W</b> black	white	-
<b>B</b> black	black	-
<b>6</b> black	-	orange transp.

**Rocker legend**

Surface	Illustration	Colour of print	Surface	Illustration	Colour of print
<b>F</b> embossed / Relief			<b>M</b> printed		black
<b>H</b> printed / bedruckt		white / weiss	<b>P</b> printed		white
<b>K</b> printed / bedruckt		black / schwarz	<b>R</b> printed		black
<b>L</b> printed / bedruckt		white / weiss			

Position of the rocker legend e.g F

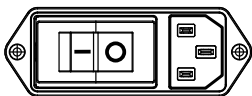

**Rated current:**

- Without thermal overload protection: code C00 }  $I_n = 20\text{ A}$
- With thermal overload protection: rated current  $I_n$  (A)

$I_n$	Code	$I_n$	Code	$I_n$	Code	$I_n$	Code
0,1	J01	1,3	J13	2,8	J28	10,0	100
0,2	J02	1,4	J14	3,0	030	11,0	110
0,3	J03	1,5	J15	3,5	035	12,0	120
0,4	J04	1,6	J16	4,0	040	13,0	130
0,5	J05	1,7	J17	4,5	045	14,0	140
0,6	J06	1,8	J18	5,0	050	15,0	150
0,7	J07	1,9	J19	6,0	060		
0,8	J08	2,0	J20	6,5	065		
0,9	J09	2,1	J21	7,0	070		
1,0	J10	2,2	J22	7,5	075		
1,1	J11	2,3	J23	8,0	080		
1,2	J12	2,5	J25	9,0	090		

**Without release: code C0**

**Undervoltage release**

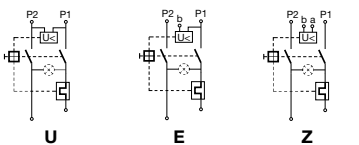

•	•	•
•	•	•
•	•	•

**Remote trip release**

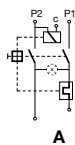

Code	Rated voltage $U_n$
•	<b>2</b> 240 V AC
•	<b>3</b> 230 V AC
•	<b>4</b> 120 V AC

**Technical data (continued)**  
**Circuit breaker**

Tripping characteristics  
 $I_n < 3 A$

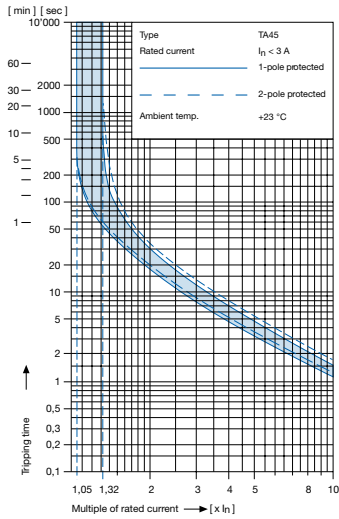

Tripping characteristics  
 $I_n \geq 3 \dots \leq 15 A$

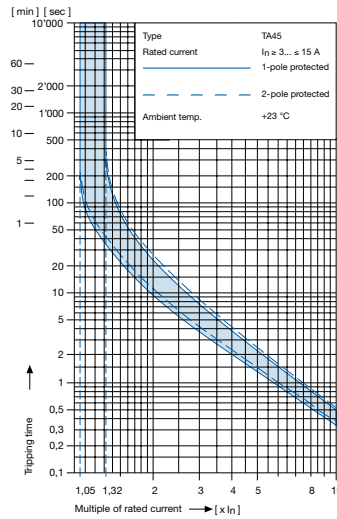

**Effect of ambient temperature <sup>1)</sup>**

The unit is calibrated for an ambient temperature of +23 °C. To determine the rated current for a lower or higher ambient temperature, use a correction factor from the table below.

**\* Ambient temperature [°C] Correction factor**

-10	0,89
- 5	0,91
0	0,92
+23	1,00
+30	1,03
+40	1,08
+55	1,16

\* Temperature must be measured at the rear of the breaker next to the terminals after equipment operating temperature has been reached.

**<sup>1)</sup> Example**

Rated current at +23 °C	6,0 A
Ambient temperature	+40 °C
Correction factor	1,08
Chosen rated current at + 40 °C ambient temperature	<b>6 A x 1,08 = 6,5 A</b>

**Order code (Order example)**

<b>Type</b>	<b>Order code TA45</b> (2-pole rocker-switch without accessories)	. 0 0 1	<b>Wiring</b> 0 Without 1 With
<b>5145.</b>	<b>A B T W F 1 5 0 C 0</b> see table 1		<b>Type of line filter</b> 1 Standard 3 Medical
			<b>Rated current of line filter</b> 1 1 (A)    5 6 (A) 2 2 (A)    6 8 (A) 3 3 (A)    7 10 (A) 4 4 (A)    8 15 (A)

Please note that Schurter will establish an internal part number for logistical use in additional to the order code. The format of this internal part number is, for example 5145.0031.001