

**Cooper Bussmann**

[Homepage](#)  
[About Cooper Bussmann](#)  
[Contact Us](#)  
[Privacy](#)  
[Legal](#)  
[Cooper Bussmann® Brand](#)  
[Site Map](#)



**ATC-4**  
 AUTOMOTIVE BLADE TYPE FUSE

**Product Information**

Product Type:	Fuse
Product Family:	Automotive

**Recommended Products**

Rec. Inline Fuse Holder:	<a href="#">HHD</a>
--------------------------	---------------------

**Electrical Properties**

Maximum DC Voltage:	32
Amperage Rating:	4
DC Interrupting Ratings:	<ul style="list-style-type: none"> <li>• 1000 at 32V</li> </ul>
Fast Acting:	Yes

# Blade-Type Automotive Fuses

## ATC Series, Fast Acting

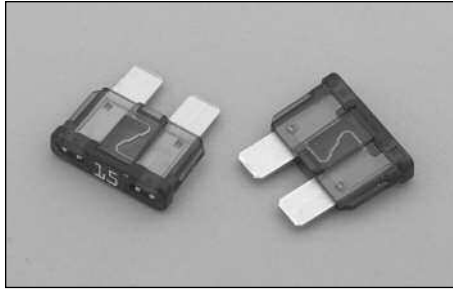

### Dimensional Data

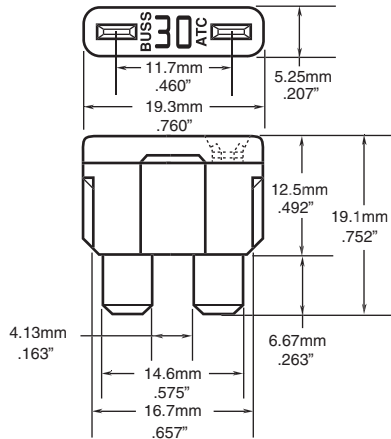

**Catalog Symbol:** ATC

**Fast-Acting**

**Ampere Rating:** 1 to 40 Amperes

**Interrupting Rating:** 1,000 Amperes

**Agency Approvals:** U.L. Recognized, (3-40A)

Guide JFHR2, File E56412

**Ordering:** Specify packaging and product code

### SPECIFICATIONS

Product Code	Body Color	Voltage Rating DC
ATC-1	Black	32V
ATC-2	Gray	32V
ATC-3	Violet	32V
ATC-4	Pink	32V
ATC-5	Tan	32V
ATC-7 1/2	Brown	32V
ATC-10	Red	32V
ATC-15	Blue	32V
ATC-20	Yellow	32V
ATC-25	Clear	32V
ATC-30	Green	32V
ATC-40	Amber	32V

### Time-Current Characteristic Curves—Average Melt

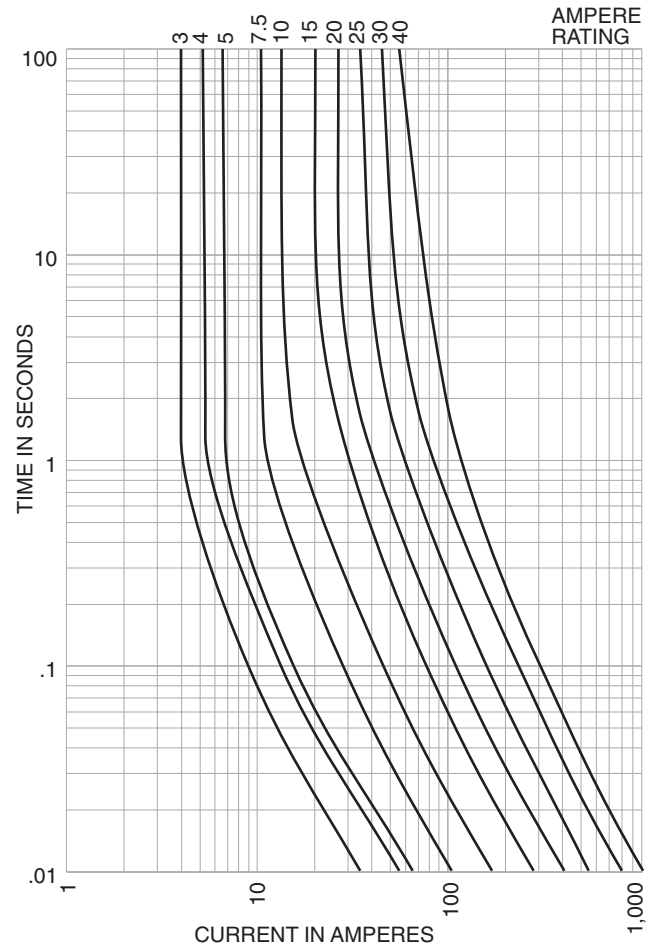

### Recommended Bussmann Fuseholders\*

Blade-Type	Part	Description	Fuse Size	Wire Size
	HHC	Yellow Fuseholder	3-20 Amps	#16 Lead Wire
	HHF	Black Fuseholder w/cover	3-20 Amps	#14 Lead Wire
ATC	HHD	Black Fuseholder	3-30 Amps	#12 Lead Wire
	HHG	Black Fuseholder w/cover	3-30 Amps	#12 Lead Wire
	HHD-C	Cover Only	—	—

\*Also used in Bussmann 1A5600 Fuse Clips (0-20A)

### PACKAGING CODE

Packaging Code	Description
Blank	5 pieces of fuses packed in a tin
BK	2,000 pieces of fuses packed in a carton